

# User's Guide

## NR/FWA Indoor Series

### Default Login Details

LAN IP Address	http://192.168.1.1
Login	admin
Password	See the device label

Version 1.00–4.40 Ed 5, 06/2024

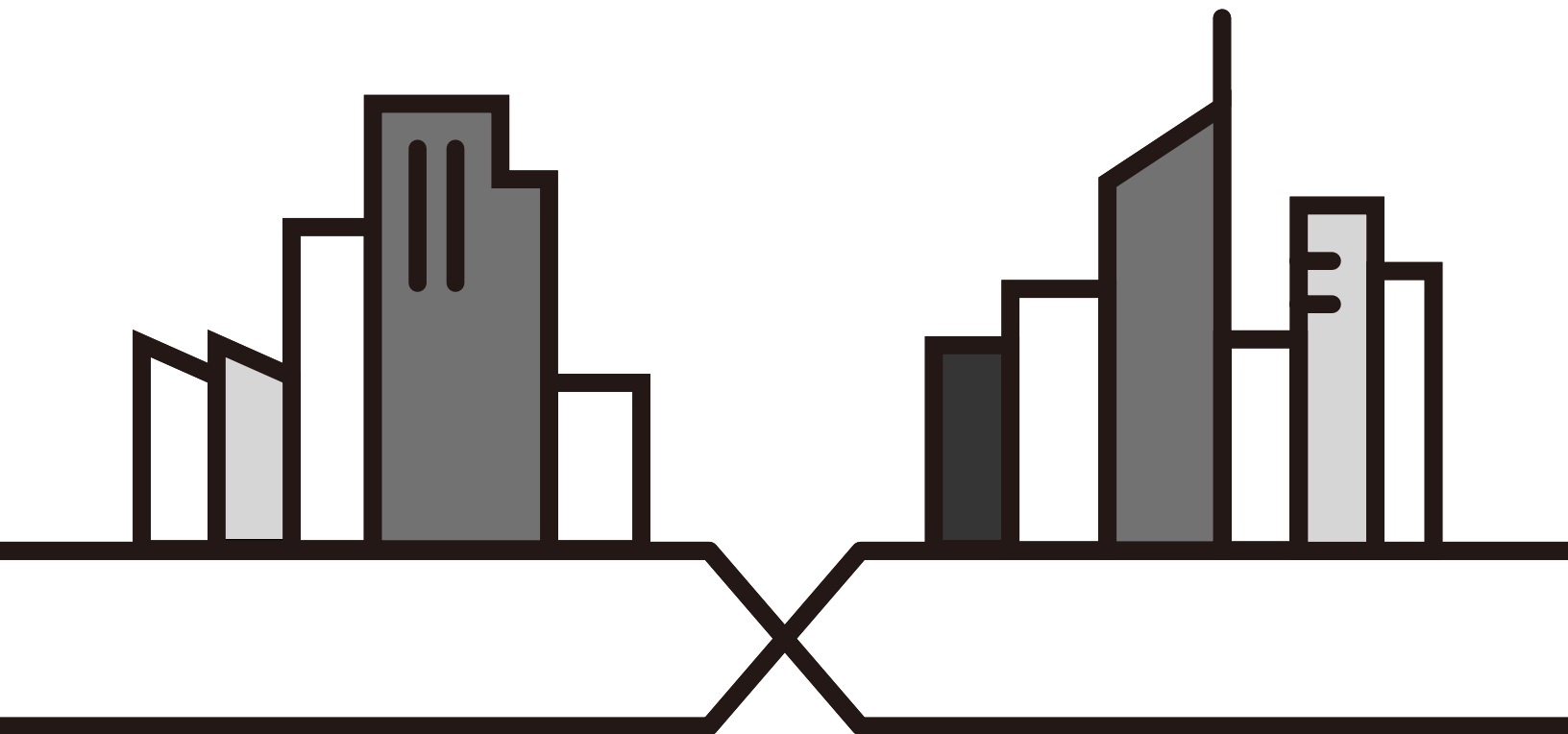

---

**IMPORTANT!**

**READ CAREFULLY BEFORE USE.**

**KEEP THIS GUIDE FOR FUTURE REFERENCE.**

This is a User's Guide for a series of products. Not all products support all firmware features. Screenshots and graphics in this book may differ slightly from your product due to differences in product features or Web Configurator brand style. Every effort has been made to ensure that the information in this manual is accurate.

### **Related Documentation**

- Quick Start Guide

The Quick Start Guide shows how to connect the Zyxel Device.

- More Information

Go to <https://service-provider.zyxel.com/global/en/tech-support> to find other information on Zyxel Device.



# Document Conventions

## Warnings and Notes

These are how warnings and notes are shown in this guide.

**Warnings tell you about things that could harm you or your Zyxel Device.**









Note: Notes tell you other important information (for example, other things you may need to configure or helpful tips) or recommendations.

## Syntax Conventions

- The NR (5G) or FWA device in this user's guide will be referred to as the "Zyxel Device".
- Product labels, screen names, field labels and field choices are all in **bold** font.
- A right angle bracket ( > ) within a screen name denotes a mouse click. For example, **Network Setting > Routing > DNS Route** means you first click **Network Setting** in the navigation panel, then the **Routing** submenu, and then finally the **DNS Route** tab to get to that screen.

## Icons Used in Figures

Figures in this user guide may use the following generic icons. The Zyxel Device icon is not an exact representation of your Zyxel Device.

Zyxel Device 	Generic Router 	Switch 
Server 	Firewall 	USB Storage Device 
Printer 	4G LTE/5G NR Base Station 	

# Contents Overview

<b>User's Guide</b> .....	<b>16</b>
Introduction .....	17
Hardware .....	28
Web Configurator .....	48
Quick Start .....	57
Web Interface Tutorials .....	59
<b>Technical Reference</b> .....	<b>103</b>
Connection Status .....	104
Broadband .....	117
Wireless .....	141
Home Networking .....	172
Routing .....	192
Quality of Service (QoS) .....	203
Network Address Translation (NAT) .....	211
DNS .....	224
USB Service .....	229
Firewall .....	234
MAC Filter .....	245
Parental Control .....	248
Certificates .....	254
Voice .....	264
Log .....	292
Traffic Status .....	294
VoIP Status .....	298
ARP Table .....	301
Routing Table .....	303
WLAN Station Status .....	306
Cellular WAN Status .....	308
System .....	314
User Account .....	315
Remote Management .....	319
TR-069 Client .....	325
Time Settings .....	328
Email Notification .....	331
Log Setting .....	334
Firmware Upgrade .....	338
Backup/Restore .....	342

Diagnostic ..... 348

**Troubleshooting and Appendices .....350**

    Troubleshooting ..... 351

# Table of Contents

<b>Document Conventions .....</b>	<b>3</b>
<b>Contents Overview .....</b>	<b>4</b>
<b>Table of Contents .....</b>	<b>6</b>
<b>Part I: User's Guide.....</b>	<b>16</b>
<b>Chapter 1</b>	
<b>Introduction.....</b>	<b>17</b>
1.1 Overview .....	17
1.1.1 Model Feature Differences .....	17
1.2 Applications for the Zyxel Device .....	19
1.3 EasyMesh .....	21
1.3.1 Network Controller .....	21
1.3.2 Dual-Band WiFi .....	22
1.3.3 AP Steering .....	23
1.3.4 Band Steering .....	23
1.3.5 Daisy Chain .....	24
1.4 MU-MIMO Technology .....	25
1.5 How to Manage your Zyxel Device .....	27
1.6 Good Habits for Managing the Zyxel Device .....	27
<b>Chapter 2</b>	
<b>Hardware.....</b>	<b>28</b>
2.1 Overview .....	28
2.2 LEDs .....	28
2.3 SIM Card Slot .....	33
2.4 External Antenna Connector .....	34
2.5 Ports and Buttons .....	37
2.6 How to Enable WiFi/WPS .....	42
2.6.1 NR5101 WiFi/WPS Button .....	42
2.6.2 NR5103 / NR5103E / NR5103EV2 / NR5103EV3 / FWA510 WiFi/WPS Button .....	43
2.7 How to Reset the Zyxel Device .....	45
<b>Chapter 3</b>	
<b>Web Configurator.....</b>	<b>48</b>
3.1 Overview .....	48

3.1.1 Access the Web Configurator .....	48
3.2 Web Configurator Layout .....	50
3.2.1 Settings Icon .....	50
3.2.2 Widget Icon .....	56
<b>Chapter 4</b>	
<b>Quick Start.....</b>	<b>57</b>
4.1 Quick Start Overview .....	57
4.2 Quick Start Setup .....	57
4.3 Quick Start Setup – Time Zone .....	57
4.4 Quick Start Setup – WiFi .....	58
4.5 Quick Start Setup – Finish .....	58
<b>Chapter 5</b>	
<b>Web Interface Tutorials.....</b>	<b>59</b>
5.1 Web Interface Overview .....	59
5.2 Wired Network Setup .....	59
5.2.1 Setting Up an Ethernet Connection .....	59
5.3 WiFi Network Setup .....	63
5.3.1 Changing Security on a WiFi Network .....	63
5.3.2 Connecting to the Zyxel Device's WiFi Network Using WPS .....	65
5.3.3 WPS Push Button Configuration (PBC) .....	65
5.3.4 Setting Up a Guest Network .....	69
5.3.5 Setting Up Two Guest WiFi Networks on Different WiFi Bands .....	73
5.4 Cellular Network Setup .....	78
5.4.1 Setting up a Cellular Network Connection .....	78
5.5 USB Applications .....	78
5.5.1 File Sharing .....	78
5.6 Network Security .....	83
5.6.1 Configuring a Firewall Rule .....	83
5.6.2 Parental Control .....	85
5.6.3 Configuring a MAC Address Filter for Wired LAN Connections .....	88
5.7 Internet Calls .....	90
5.7.1 Configuring VoIP .....	90
5.7.2 Adding a SIP Service Provider .....	90
5.7.3 Adding a SIP Account .....	91
5.7.4 Configuring a Phone .....	93
5.7.5 Making a VoIP Call .....	94
5.7.6 Making a VoLTE Phone Call .....	94
5.8 Device Maintenance .....	94
5.8.1 Upgrading the Firmware .....	94
5.8.2 Backing up the Device Configuration .....	95
5.8.3 Restoring the Device Configuration .....	97

5.8.4 Making a VoLTE Phone Call ..... 99

5.9 Remote Access from WAN ..... 100

5.9.1 Configure Access to Your Zyxel Device ..... 100

5.9.2 Configure the Trust Domain ..... 102

**Part II: Technical Reference..... 103**

**Chapter 6  
Connection Status..... 104**

6.1 Connection Status Overview ..... 104

6.1.1 Connectivity ..... 104

6.1.2 Icon and Device Name ..... 105

6.1.3 System Info ..... 105

6.1.4 Cellular Info ..... 107

6.1.5 WiFi Settings ..... 112

6.2 Guest WiFi Settings ..... 113

6.2.1 LAN ..... 115

**Chapter 7  
Broadband..... 117**

7.1 Broadband Overview ..... 117

7.1.1 What You Can Do in this Chapter ..... 117

7.1.2 What You Need to Know ..... 118

7.1.3 Before You Begin ..... 119

7.2 Broadband ..... 119

7.2.1 Add or Edit Internet Connection ..... 120

7.3 WAN Backup ..... 124

7.4 Ethernet WAN ..... 125

7.5 Cellular WAN ..... 126

7.6 Cellular APN ..... 127

7.6.1 Edit Cellular APN1/APN2 ..... 128

7.6.2 Using Separate APNs for Data and Management Traffic ..... 130

7.7 Cellular SIM Configuration ..... 131

7.8 Cellular Band Configuration ..... 133

7.9 Cellular PLMN Configuration ..... 133

7.10 Cellular IP Passthrough ..... 136

7.11 Cellular SMS ..... 137

7.11.1 Send New Message Screen ..... 139

**Chapter 8  
Wireless ..... 141**



8.1 Wireless Overview .....	141
8.1.1 What You Can Do in this Chapter .....	141
8.1.2 What You Need to Know .....	141
8.2 Wireless General Settings .....	142
8.2.1 No Security .....	145
8.2.2 More Secure (Recommended) .....	145
8.3 Guest/More AP Screen .....	147
8.3.1 The Edit Guest/More AP Screen .....	148
8.4 MAC Authentication .....	149
8.5 WPS .....	151
8.6 WMM .....	153
8.7 Others Screen .....	154
8.8 Channel Status .....	156
8.9 WLAN Scheduler .....	158
8.9.1 Add or Edit Rules .....	159
8.10 EasyMesh .....	160
8.11 Technical Reference .....	161
8.11.1 WiFi Network Overview .....	161
8.11.2 Additional WiFi Terms .....	163
8.11.3 WiFi Security Overview .....	163
8.11.4 Signal Problems .....	165
8.11.5 BSS .....	165
8.11.6 MBSSID .....	166
8.11.7 Preamble Type .....	166
8.11.8 WiFi Protected Setup (WPS) .....	166
<b>Chapter 9</b>	
<b>Home Networking.....</b>	<b>172</b>
9.1 Home Networking Overview .....	172
9.1.1 What You Can Do in this Chapter .....	172
9.1.2 What You Need To Know .....	172
9.2 LAN Setup .....	174
9.3 Static DHCP .....	178
9.3.1 Before You Begin .....	178
9.4 UPnP .....	180
9.5 Technical Reference .....	181
9.5.1 DHCP Setup .....	182
9.5.2 DNS Server Addresses .....	182
9.5.3 LAN TCP/IP .....	183
9.6 Turn on UPnP in Windows 10 Example .....	184
9.6.1 Auto-discover Your UPnP-enabled Network Device .....	186
9.7 Web Configurator Access with UPnP in Windows 10 .....	189

---

<b>Chapter 10</b>	
<b>Routing</b>	<b>192</b>
10.1 Routing Overview	192
10.2 Configure Static Route	192
10.2.1 Add or Edit Static Route	193
10.3 DNS Route	197
10.3.1 Add or Edit DNS Route	198
10.4 Policy Route	199
10.4.1 Add or Edit Policy Route	200
10.5 RIP Overview	201
10.5.1 RIP	201
<b>Chapter 11</b>	
<b>Quality of Service (QoS)</b>	<b>203</b>
11.1 QoS Overview	203
11.1.1 What You Can Do in this Chapter	203
11.2 What You Need to Know	203
11.3 Quality of Service General Settings	205
11.4 Technical Reference	207
<b>Chapter 12</b>	
<b>Network Address Translation (NAT)</b>	<b>211</b>
12.1 NAT Overview	211
12.1.1 What You Can Do in this Chapter	211
12.1.2 What You Need To Know	211
12.2 Port Forwarding	212
12.2.1 Port Forwarding	212
12.2.2 Add or Edit Port Forwarding	213
12.3 Port Triggering	215
12.3.1 Add or Edit Port Triggering Rule	217
12.4 DMZ	219
12.5 ALG	219
12.6 Technical Reference	220
12.6.1 NAT Definitions	220
12.6.2 What NAT Does	221
12.6.3 How NAT Works	221
12.6.4 NAT Application	222
<b>Chapter 13</b>	
<b>DNS</b>	<b>224</b>
13.1 DNS Overview	224
13.1.1 What You Can Do in this Chapter	224
13.1.2 What You Need To Know	224

13.2 DNS Entry .....	225
13.2.1 Add or Edit DNS Entry .....	225
13.3 Dynamic DNS .....	226
<b>Chapter 14</b>	
<b>USB Service .....</b>	<b>229</b>
14.1 USB Service Overview .....	229
14.1.1 What You Need To Know .....	229
14.1.2 Before You Begin .....	230
14.2 USB Service .....	230
14.2.1 Add New Share .....	232
14.2.2 Add New User Screen .....	233
<b>Chapter 15</b>	
<b>Firewall .....</b>	<b>234</b>
15.1 Firewall Overview .....	234
15.1.1 What You Need to Know About Firewall .....	234
15.2 Firewall .....	235
15.2.1 What You Can Do in this Chapter .....	235
15.3 Firewall General Settings .....	236
15.4 Protocol (Customized Services) .....	237
15.4.1 Add Customized Service .....	238
15.5 Access Control (Rules) .....	238
15.5.1 Add New ACL Rule .....	239
15.6 DoS .....	241
15.7 Firewall Technical Reference .....	242
15.7.1 Firewall Rules Overview .....	242
15.7.2 Guidelines For Security Enhancement With Your Firewall .....	243
15.7.3 Security Considerations .....	243
<b>Chapter 16</b>	
<b>MAC Filter .....</b>	<b>245</b>
16.1 MAC Filter Overview .....	245
16.2 MAC Filter .....	245
16.2.1 Add New Rule .....	246
<b>Chapter 17</b>	
<b>Parental Control .....</b>	<b>248</b>
17.1 Parental Control Overview .....	248
17.2 Parental Control Schedule and URL Filter .....	248
17.2.1 Add or Edit a Parental Control Profile .....	249
<b>Chapter 18</b>	
<b>Certificates .....</b>	<b>254</b>

18.1 Certificates Overview .....	254
18.1.1 What You Can Do in this Chapter .....	254
18.2 What You Need to Know .....	254
18.3 Local Certificates .....	254
18.3.1 Create Certificate Request .....	256
18.3.2 View Certificate Request .....	257
18.4 Trusted CA .....	258
18.5 Import Trusted CA Certificate .....	259
18.6 View Trusted CA Certificate .....	260
18.7 Certificates Technical Reference .....	261
18.7.1 Verify a Certificate .....	262
<b>Chapter 19</b>	
<b>Voice.....</b>	<b>264</b>
19.1 Voice Overview .....	264
19.1.1 What You Can Do in this Chapter .....	264
19.2 Voice Mode .....	265
19.2.1 What You Need to Know About VoIP .....	265
19.3 Before You Begin .....	266
19.4 SIP Account .....	266
19.4.1 SIP Account Entry Edit .....	267
19.5 SIP Service Provider .....	270
19.5.1 Provider Entry Edit .....	270
19.6 Phone .....	274
19.6.1 Phone Device .....	274
19.6.2 Phone Device Edit .....	274
19.7 Phone Region .....	275
19.8 Call Rule .....	276
19.9 Call History .....	277
19.9.1 Call History Screen .....	277
19.10 Technical Reference .....	278
19.10.1 Quality of Service (QoS) .....	286
19.10.2 Phone Services Overview .....	287
<b>Chapter 20</b>	
<b>Log .....</b>	<b>292</b>
20.1 What You Need To Know .....	292
20.2 System Log .....	292
20.3 Security Log .....	293
<b>Chapter 21</b>	
<b>Traffic Status.....</b>	<b>294</b>
21.1 Traffic Status Overview .....	294

21.1.1 What You Can Do in this Chapter .....	294
21.2 WAN Status .....	294
21.3 LAN Status .....	296
<b>Chapter 22</b>	
<b>VoIP Status .....</b>	<b>298</b>
22.1 VoIP Status Screen .....	298
<b>Chapter 23</b>	
<b>ARP Table .....</b>	<b>301</b>
23.1 ARP Table Overview .....	301
23.1.1 How ARP Works .....	301
23.2 ARP Table .....	301
<b>Chapter 24</b>	
<b>Routing Table .....</b>	<b>303</b>
24.1 Routing Table Overview .....	303
24.2 Routing Table .....	303
<b>Chapter 25</b>	
<b>WLAN Station Status .....</b>	<b>306</b>
25.1 WLAN Station Status Overview .....	306
<b>Chapter 26</b>	
<b>Cellular WAN Status .....</b>	<b>308</b>
26.1 Cellular WAN Status Overview .....	308
26.2 Cellular WAN Status .....	308
<b>Chapter 27</b>	
<b>System .....</b>	<b>314</b>
27.1 System Overview .....	314
27.2 System .....	314
<b>Chapter 28</b>	
<b>User Account .....</b>	<b>315</b>
28.1 User Account Overview .....	315
28.2 User Account .....	315
28.2.1 User Account Add or Edit .....	316
<b>Chapter 29</b>	
<b>Remote Management .....</b>	<b>319</b>
29.1 Remote Management Overview .....	319
29.1.1 What You Can Do in this Chapter .....	319

29.2 MGMT Services .....	319
29.3 Trust Domain .....	321
29.3.1 Add Trust Domain .....	321
29.4 MGMT Services for IP Passthrough .....	322
29.5 Trust Domain for IP Passthrough .....	323
29.5.1 Add Trust Domain .....	324
<b>Chapter 30</b>	
<b>TR-069 Client.....</b>	<b>325</b>
30.1 TR-069 Overview .....	325
30.1.1 TR-069 Client .....	325
30.1.2 XMPP .....	325
<b>Chapter 31</b>	
<b>Time Settings.....</b>	<b>328</b>
31.1 Time Settings Overview .....	328
31.2 Time .....	328
<b>Chapter 32</b>	
<b>Email Notification.....</b>	<b>331</b>
32.1 Email Notification Overview .....	331
32.2 Email Notification .....	331
32.2.1 E-mail Notification Edit .....	332
<b>Chapter 33</b>	
<b>Log Setting .....</b>	<b>334</b>
33.1 Log Setting Overview .....	334
33.2 Log Setting .....	334
33.2.1 Example Email Log .....	336
<b>Chapter 34</b>	
<b>Firmware Upgrade.....</b>	<b>338</b>
34.1 Firmware Upgrade Overview .....	338
34.2 Firmware Upgrade .....	338
34.3 Online Upgrade .....	340
<b>Chapter 35</b>	
<b>Backup/Restore .....</b>	<b>342</b>
35.1 Backup/Restore Overview .....	342
35.2 Backup/Restore .....	342
35.3 Soft-Reset .....	346
35.4 Reboot .....	347

<b>Chapter 36</b>	
<b>Diagnostic</b> .....	<b>348</b>
36.1 Diagnostic Overview .....	348
36.1.1 What You Can Do in this Chapter .....	348
36.2 Diagnostic .....	348
<b>Part III: Troubleshooting and Appendices</b> .....	<b>350</b>
<b>Chapter 37</b>	
<b>Troubleshooting</b> .....	<b>351</b>
37.1 Troubleshooting Overview .....	351
37.2 Power and Hardware Problems .....	351
37.3 Device Access Problems .....	352
37.4 Cellular Problems .....	355
37.5 Internet Problems .....	357
37.6 WiFi Problems .....	359
37.7 USB Problems .....	360
37.8 UPnP Problems .....	360
37.9 Getting More Troubleshooting Help .....	361
Appendix A Customer Support .....	362
Appendix B IPv6.....	367
Appendix C Legal Information .....	373
<b>Index</b> .....	<b>379</b>

---

# PART I

## User's Guide

---



# CHAPTER 1

## Introduction

### 1.1 Overview

The Zyxel Device consists of the following models:

- NR5101
- NR5103
- NR5103E
- NR5103EV2
- NR5103EV3
- NR5307
- FWA510

#### 1.1.1 Model Feature Differences

The Zyxel Device is a router that supports (but not limited to) the following features. Note the following differences between the Zyxel Device models:

Table 1 Model Feature Comparison

FEATURE/MODEL	NR5101	NR5103	NR5103E	NR5103EV2/ NR5103EV3
IEEE 802.11 b/g/n/a/ac/ax WiFi	YES	YES	YES	YES
IEEE 802.11 be WiFi	NO	NO	NO	NO
Maximum 5G NR Speed	2.3 Gbps	4.7 Gbps	4.7 Gbps	4.7 Gbps
Maximum 4G LTE Speed	2 Gbps	1.6 Gbps	1.6 Gbps	1.6 Gbps
Gigabit Ethernet WAN/LAN Port	YES	YES	YES	YES
USB Port (For File Sharing)	YES	YES	YES	YES
External Antenna Connector	NO	YES	YES	YES
DHCP (Dynamic Host Configuration Protocol) Server	YES	YES	YES	YES
NAT (Network Address Translation)	YES	YES	YES	YES
DMZ (DeMilitarized Zone)	YES	YES	YES	YES
Cellular PLMN (Public Land Mobile Network) Configuration	YES	YES	YES	YES
Cellular SMS	YES	YES	YES	YES
ALG (Application Layer Gateway)	YES	NO	NO	NO
Security Mode	WPA2-PSK	WPA3-SAE/ WPA2-PSK	WPA3-SAE/ WPA2-PSK	WPA3-SAE/ WPA2-PSK

Table 1 Model Feature Comparison (continued)

FEATURE/MODEL	NR5101	NR5103	NR5103E	NR5103EV2/ NR5103EV3
Policy Route	YES	NO	NO	NO
Static / Dynamic Route Setting Using RIP	YES	YES	YES	YES
Port Forwarding / Port Triggering	YES/YES	YES/NO	YES/NO	YES/NO
ARP (Address Resolution Protocol)	YES	YES	YES	YES
Dynamic DNS	YES	NO	NO	NO
Parental Control	YES	NO	YES	YES
Denial of Service (DoS) Protection	YES	YES	YES	YES
Voice Functions	YES	NO	NO	NO
VoLTE	YES	NO	NO	NO
VoIP	YES	NO	NO	NO
Email Notification	YES	NO	NO	NO
Save Configuration / Upload the Stored Configuration File	YES	YES	YES	YES
EasyMesh Supported Extender	NO	WSM20	NO	NO
MU-MIMO Technology	NO	YES	NO	NO

Table 2 Model Feature Comparison

FEATURE/MODEL	NR5307	FWA510
IEEE 802.11 b/g/n/a/ac/ax WiFi	YES	YES
IEEE 802.11 be WiFi	YES	NO
Maximum 5G NR Speed	7.01 Gbps	4.7 Gbps
Maximum 4G LTE Speed	1.6 Gbps	1.6 Gbps
Gigabit Ethernet WAN/LAN Port	YES	YES
USB Port (For File Sharing)	YES	YES
External Antenna Connector	YES	YES
DHCP (Dynamic Host Configuration Protocol) Server	YES	YES
NAT (Network Address Translation)	YES	YES
DMZ (DeMilitarized Zone)	YES	YES
Cellular PLMN (Public Land Mobile Network) Configuration	YES	YES
Cellular SMS	YES	YES
ALG (Application Layer Gateway)	NO	NO
Security Mode	WPA3-SAE/ WPA2-PSK	WPA3-SAE/ WPA2-PSK
Policy Route	NO	NO
Static / Dynamic Route Setting Using RIP	YES	YES
Port Forwarding / Port Triggering	YES/NO	YES/NO

Table 2 Model Feature Comparison (continued)

FEATURE/MODEL	NR5307	FWA510
ARP (Address Resolution Protocol)	YES	YES
Dynamic DNS	YES	NO
Parental Control	NO	NO
Denial of Service (DoS) Protection	YES	YES
Voice Functions	NO	NO
VoLTE	NO	NO
VoIP	NO	NO
Email Notification	NO	NO
Save Configuration / Upload the Stored Configuration File	YES	YES
EasyMesh Supported Extender	YES	WSM20
MU-MIMO Technology	Matrix A, Matrix B mode	YES

## 1.2 Applications for the Zyxel Device

### Wireless WAN

The Zyxel Device can connect to the Internet through a cellular SIM card to access a wireless WAN connection. Just insert a SIM card into the SIM card slot at the bottom of the Zyxel Device.

Note: You must insert the SIM card into the card slot before turning on the Zyxel Device.

Note: You can install external antennas to improve your wireless WAN signal strength.

### Internet Access

Your Zyxel Device provides shared Internet access by connecting to a cellular network. Connect a computer to the Zyxel Device's LAN port or wirelessly for Internet access.

Figure 1 Zyxel Device's Internet Access Application

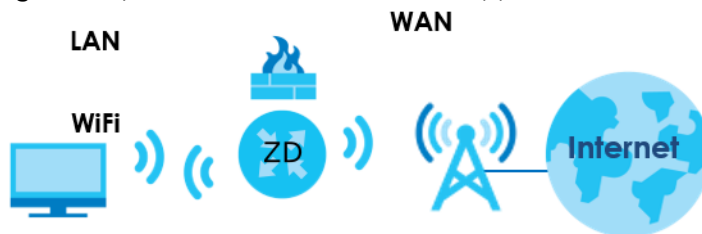

## Ethernet WAN

If you have another broadband modem or router available, you can use the Ethernet WAN port and then connect it to the broadband modem or router. This way, you can access the Internet through an Ethernet WAN connection.

**Figure 2** Zyxel Device's Internet Access Application: Ethernet WAN

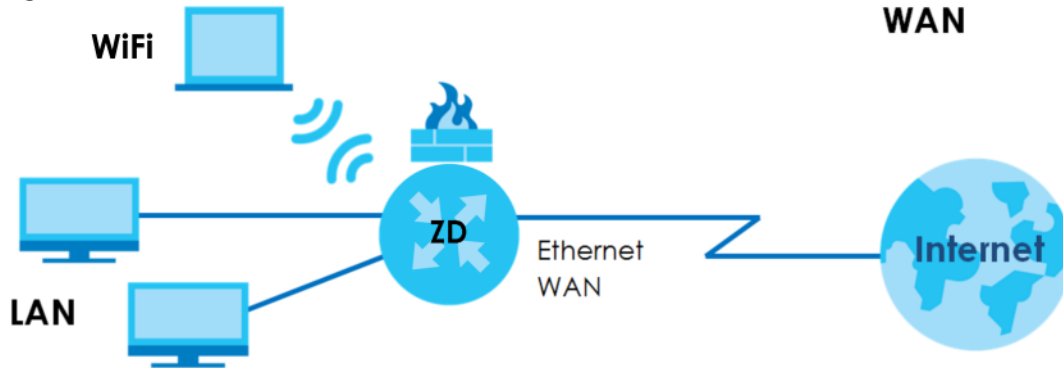

## Wireless LAN (WiFi)

Wireless clients can connect to the Zyxel Device WiFi network to access network resources. The Zyxel Device supports WiFi Protected Setup (WPS), which allows you to quickly set up a WiFi connection between the Zyxel Device and a WiFi client with strong security.

**Figure 3** Zyxel Device's WiFi

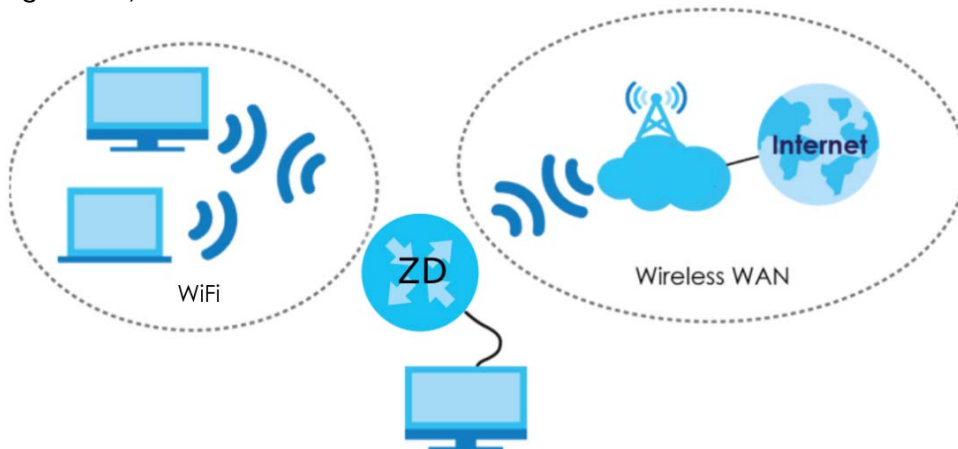

## Carrier Aggregation

Carrier Aggregation (CA) is a technology to deliver high downlink data rates by combining more than one carrier in the same or different bands together. You can use data rates from Primary Component Carrier (PCC) and Secondary Component Carrier (SCC) of other neighboring base stations. The Secondary Component Carriers can be added or removed as needed to increase/decrease bandwidth.

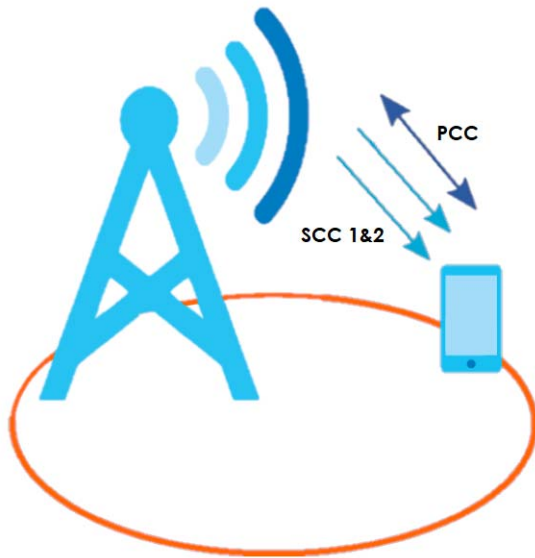
**Figure 4** Carrier Aggregation Application

## 1.3 EasyMesh

An EasyMesh network is composed of three key components.

(A) A router works as a controller to manage and optimize the EasyMesh network.

(B) One or more devices in the EasyMesh network function as APs or WiFi Extenders to extend the WiFi communication range.

(C) Multiple client devices connect to the EasyMesh network for Internet connections.

### 1.3.1 Network Controller

The Zyxel Device functions as a controller to coordinate and optimize WiFi activity in the EasyMesh network. The controller collects Channel Availability Check responses and scan reports from the APs or WiFi Extenders. Then, the controller selects the best channel and the final optimized topology based on the current situation.

The EasyMesh network uses AP steering and Band steering mechanisms to improve WiFi performance. AP steering allows WiFi clients to roam seamlessly in an EasyMesh network. Band steering allows 2.4 GHz / 5 GHz dual-band WiFi clients to move from one band to another less busy band. For AP steering to work, the controller and the devices in the EasyMesh network must use the same SSID and password. For band steering to work, the SSIDs and passwords of 2.4 GHz and 5 GHz must be identical. See [Section 1.3.3 on page 23](#) and [Section 1.3.4 on page 23](#) for more information. The controller synchronizes the SSIDs and passwords during auto-configuration.

- The Zyxel Device connects to an AP using an Ethernet cable to expand the WiFi coverage.
- The Zyxel Device connects to a WiFi extender using WiFi. You can place the WiFi extender between the Zyxel Device and the WiFi clients who require WiFi but are not in the coverage of the Zyxel Device.

Figure 5 EasyMesh Application

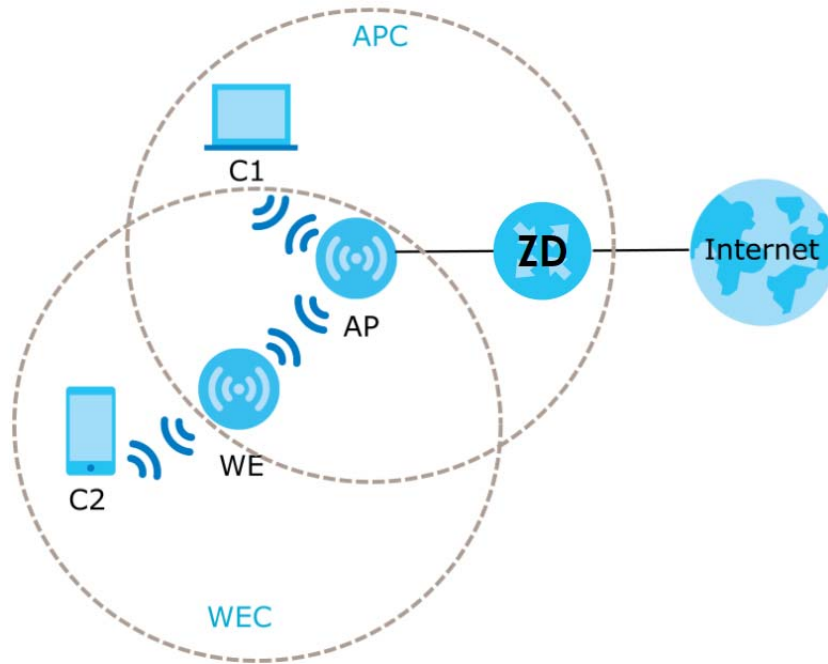

The following table describes the icons used in the figure.

Table 3 EasyMesh Application

LABEL	DESCRIPTION
ZD	Router Controller
AP	Access Point
WE	WiFi Extender
C1	Client1
C2	Client2
APC	Access Point coverage area
WEC	WiFi Extender coverage area

### 1.3.2 Dual-Band WiFi

The Zyxel Device supports dual-band 2.4 GHz and 5 GHz WiFi. IEEE 80211a/b/g/n/ac/ax/be compliant clients, such as notebooks, tablets, and smartphones can wirelessly connect to the Zyxel Device to access network resources. WiFi clients can use the 2.4 GHz band for regular Internet surfing and downloading while using the 5 GHz band for time sensitive traffic like high-definition video, music, and gaming.

Figure 6 Dual-Band WiFi Application

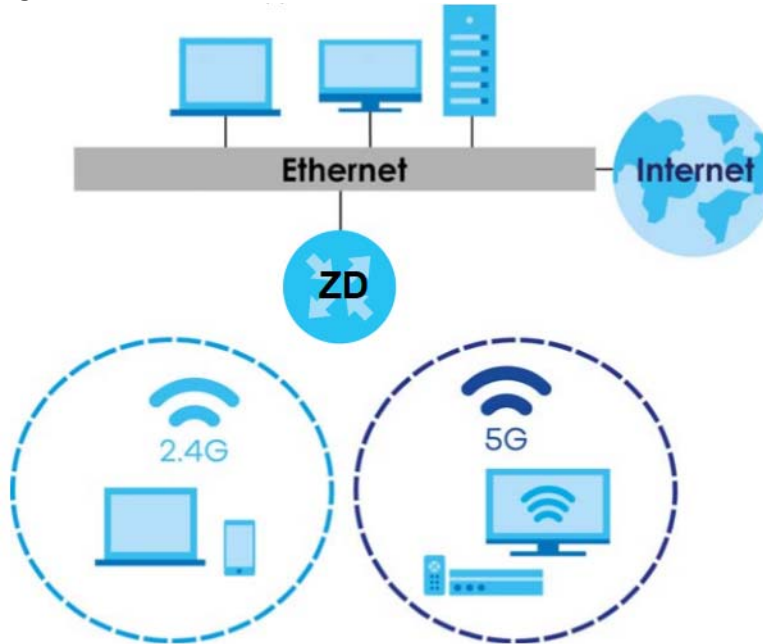

### 1.3.3 AP Steering

AP steering allows WiFi clients to roam seamlessly in the EasyMesh network. AP steering helps monitor WiFi clients and drops their connections to optimize the Zyxel Device bandwidth when the clients are idle or have a low signal. When a WiFi client is dropped, it has the opportunity to reconnect to an AP or WiFi Extender with a stronger signal.

In the following example, the controller (ZD) drops the connection between the client device (C) and the WiFi Extender (WE) so that the client device (C) can connect to the Access Point (AP), which has a stronger signal.

Figure 7 AP Steering Application

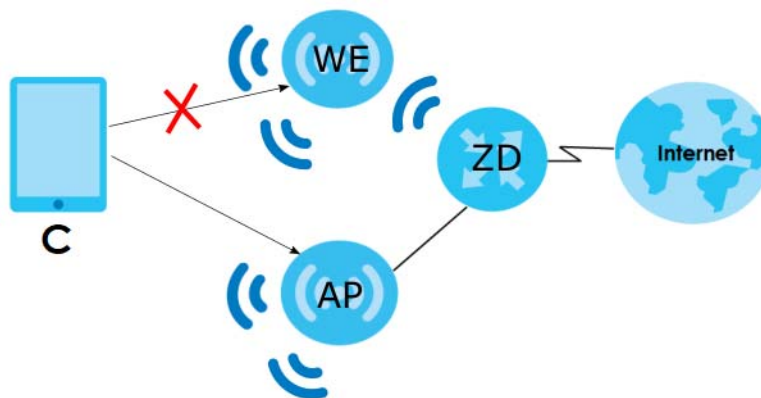

### 1.3.4 Band Steering

Band steering allows 2.4 GHz / 5 GHz dual-band WiFi clients to move from one band to another. The controller detects if the client device are dual-band compatible. If a client device supports dual-band

WiFi and the 2.4 GHz band is congested, its 2.4 GHz connection is dropped so that it can connect to the less congested 5 GHz band.

In the following example, the Apple TV is a dual-band client device that uses the 5 GHz band.

**Figure 8** Band Steering Application

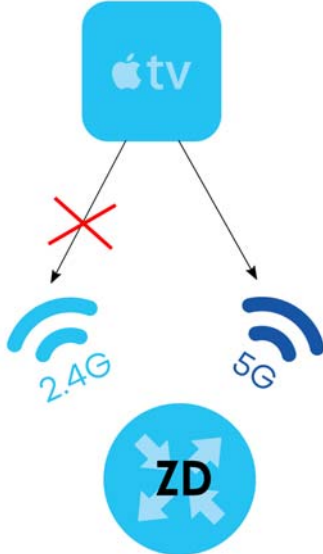

### 1.3.5 Daisy Chain

You can add more APs or WiFi Extenders to your EasyMesh network to form a daisy chain. Daisy chain refers to the connection from the Zykel Device to up to 3 APs or WiFi Extenders to extend the WiFi connection from the router to the client.

- If the Zykel Device has a wired downlink connection, the device connected to the Zykel Device must be an AP.
- If the Zykel Device has a WiFi downlink connection, the device connected to the Zykel Device must be a WiFi Extender.

Here are some example scenarios of the Zykel Device's daisy chain connection:

**Figure 9** Scenario 1: Three APs

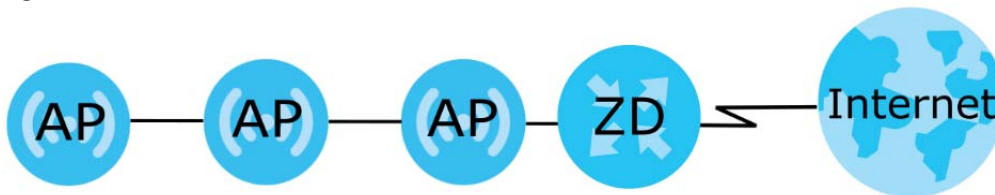

**Figure 10** Scenario 2: Two APs and one WE

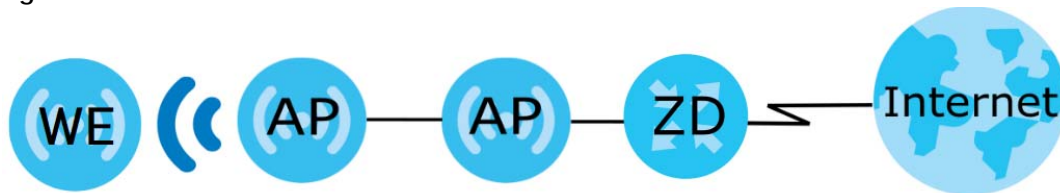



Figure 11 Scenario 3: One AP and two WEs

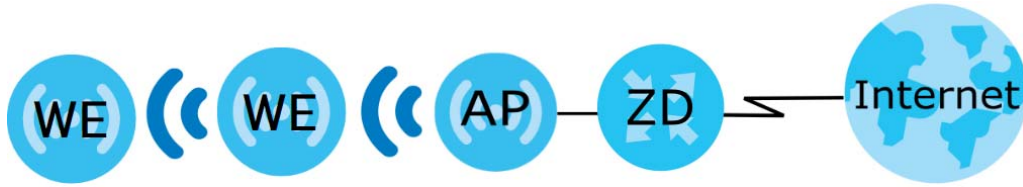

Figure 12 Scenario 4: Two WEs



Note: We do not recommend connecting more than 3 APs or WiFi Extenders in your daisy chain network.

Note: If one of the WiFi Extenders has a WiFi uplink connection, we do not recommend linking the other WiFi Extenders in your daisy chain network with a wired connection.

Figure 13 Not Recommended Connection Example

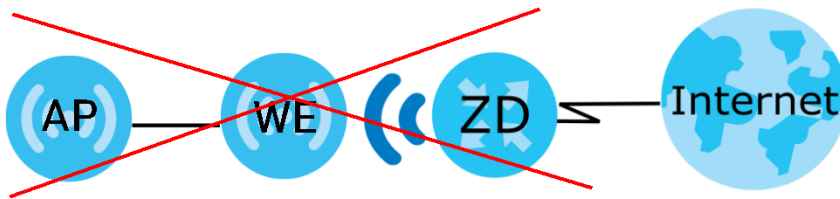

## 1.4 MU-MIMO Technology

Multi-User, Multiple-Input, Multiple-Output (MU-MIMO) allows an AP to transmit and receive data to multiple groups of MU-MIMO enabled WiFi clients at the same time, using a technology called RF multipath. MU-MIMO divides its bandwidth evenly among all MIMO-compatible WiFi clients and keeping the WiFi signal constant for them all. Transmit Beamforming technology lets the AP focus its signals directly to WiFi clients to effectively extend the WiFi coverage and minimize dead spots. WiFi clients in the same group can also co-ordinate in order to transmit to the AP at the same time. MU-MIMO helps decrease client waiting time and increase network throughput. This will improve WiFi performance with MU-MIMO compatible WiFi clients.

### 2X2:2 MU-MIMO

2X2:2 MU-MIMO WiFi means an AP allows two transceivers and two receivers to communicate concurrently with multiple WiFi clients, dividing up the bandwidth evenly. In **2X2:2**, the first and second number (**n X n**) show the number of transmit and receive antennas respectively. The third number (**: n**) means the number of data spatial streams, indicating the number of independent data signals that can be sent simultaneously from a single transmit antenna. For example, in **Figure 12**, when two WiFi devices are connected to an AP, the AP can communicate with two devices (Client **C1** and **C2**) simultaneously.

Figure 14 2X2:2 MU-MIMO

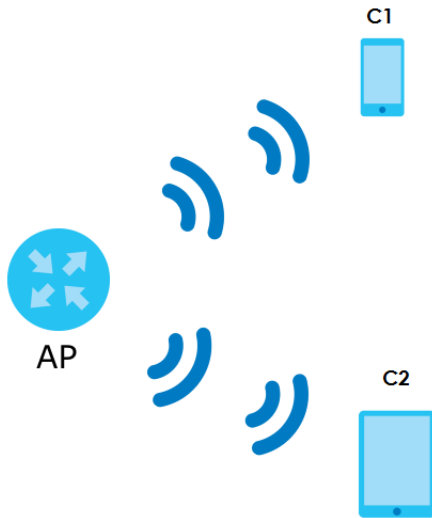

### 4X4:4 MU-MIMO

4X4:4 MU-MIMO WiFi means an AP allows 4 transceivers and 4 receivers to communicate concurrently with multiple WiFi clients, dividing up the bandwidth evenly. For example, in **Figure 13**, when 4 WiFi devices are connected to an AP, the AP can communicate with 4 devices (Client C1, C2, C3 and C4) simultaneously.

Figure 15 4X4:4 MU-MIMO

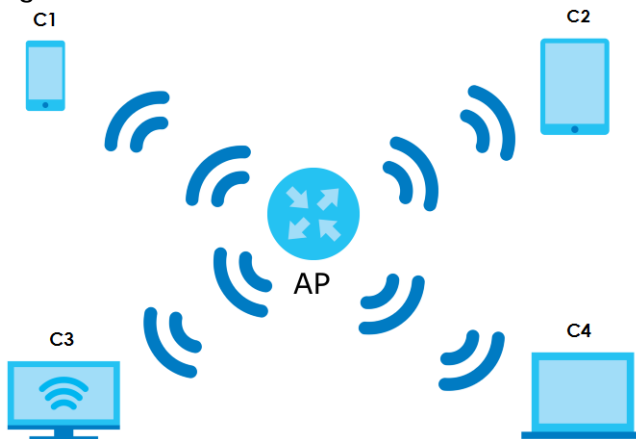

### 2.4 GHz / 5 GHz MU-MIMO

The 802.11ac standard supports only downlink traffic on the 5 GHz band while 802.11ax supports both downlink and uplink connectivity on the 2.4 GHz and 5 GHz bands.

In a Mesh network, a downlink connection means transmitting data from an AP to a WiFi client. The AP serves as the transmitter and the WiFi client as the receiver. An uplink connection means transmitting data from a WiFi client to an AP. An Uplink connection means the AP is the receiver and the WiFi client, the transmitter.

Table 4 2.4 GHz / 5 GHz MU-MIMO

	TYPE	802.11b/g/n	802.11ac	802.11ax	802.11be
2.4 GHz WiFi	Downlink	N/A	N/A	YES	YES
	Uplink	N/A	N/A	YES	YES
5 GHz WiFi	Downlink	N/A	YES	YES	YES
	Uplink	N/A	NO	YES	YES

## 1.5 How to Manage your Zyxel Device

You can use the following way to manage your Zyxel Device.

- Web Configurator. This is recommended for everyday management of Zyxel Device using a (supported) web browser.
- Zyxel Air. Use the Zyxel Air app (available on the App Store for Apple devices and Google Play for Android devices) for setup and management of the Zyxel Device on your smartphone. You can also use the app for finding the optimal 5G NR signal strength. To install the app, scan the QR code on the QSG.

Note: The embedded Web-based Configurator enables straightforward management and maintenance. Just insert the SIM card (with an active data plan) and make the hardware connections. See the Quick Start Guide for how to do the hardware installation, wall or pole mounting, and Internet setup.

## 1.6 Good Habits for Managing the Zyxel Device

Do the following things regularly to make the Zyxel Device more secure and to manage the Zyxel Device more effectively.

- Change the password. Use a password that is not easy to guess and that consists of different types of characters, such as numbers and letters.
- Write down the password and put it in a safe place.
- Back up the configuration (and make sure you know how to restore it). Restoring an earlier working configuration may be useful if the Zyxel Device becomes unstable or even crashes. If you forget your password to access the Web Configurator, you will have to reset the Zyxel Device to its factory default settings. If you backed up an earlier configuration file, you would not have to totally re-configure the Zyxel Device. You could simply restore your last configuration. Write down any information your ISP provides you.

# CHAPTER 2

## Hardware

### 2.1 Overview

This chapter describes the [LEDs](#), [External Antenna Connector](#) and [Ports and Buttons](#) on the Zyxel Device and shows you how to make the hardware connections.

### 2.2 LEDs

The following figures show LEDs on the Zyxel Device. Check the LED tables below to see the WiFi or cellular connection status of the Zyxel Device.

**Figure 16** NR5101 LEDs

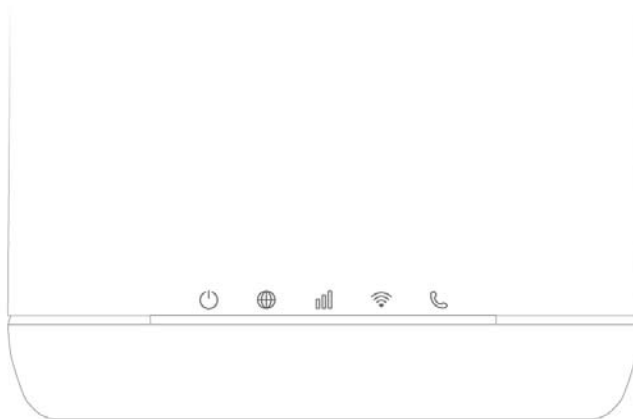

**Table 5** NR5101 LED Behavior

LED	COLOR	STATUS	DESCRIPTION
Power/USB	Green	On	The Zyxel Device is receiving power and ready for use.
		Blinking	The Zyxel Device is booting.
		Off	The Zyxel Device is not receiving power.
	Blue	On	A USB device is connected to the USB port on the Zyxel Device.
Internet/SMS	Green	On	The Zyxel Device is connected to the Internet using 3G/4G.
		Blinking	There is a new SMS message.
		Off	The Zyxel Device is not connected to the Internet.
	Blue	On	The Zyxel Device is connected to the Internet using 5G.
		Blinking	The Zyxel Device has a weak signal or there is a problem with the SIM card.

Table 5 NR5101 LED Behavior (continued)

LED	COLOR	STATUS	DESCRIPTION
Cellular Signal Strength	Green	On	The signal strength is excellent.
	Orange	On	The signal strength is fair.
	Red	On	The signal strength is poor.
		Blinking	There is no cellular signal, or signal strength is below the poor level.
WiFi/WPS	Green	On	WiFi is enabled.
		Blinking (fast)	Data is being transmitted and received.
		Blinking (slow)	WPS is activated, and the Zyxel Device is establishing a WPS connection.
Voice	Green	On	A telephone connected to the <b>PHONE</b> port has its receiver off the hook.
		Blinking	The Zyxel Device is receiving an incoming call.
		Off	A telephone connected to the <b>PHONE</b> port has its receiver on the hook.

Figure 17 NR5103 / NR5103E / FWA510 LEDs



Table 6 NR5103 / FWA510 LED Behavior

LED	COLOR	STATUS	DESCRIPTION
Power	Green	On	The Zyxel Device is receiving power and ready for use.
		Blinking	The Zyxel Device is booting.
		Off	The Zyxel Device is not receiving power.
SMS	Green	On	There is a new SMS message.
		Blinking	The Inbox is full.
		Off	There is no unread SMS message.
Cellular Signal Strength	Blue	On	The signal strength is good.
	Green	On	The signal strength is medium.
	Red	On	The signal strength is poor.
		Blinking	There is no cellular signal, or signal strength is below the poor level.
		Off	The Zyxel Device is booting.

Table 6 NR5103 / FWA510 LED Behavior (continued)

LED	COLOR	STATUS	DESCRIPTION
Internet	Blue	On	The Zyxel Device is connected to the Internet using 5G.
	Green	On	The Zyxel Device is connected to the Internet using 4G, or is connected in Ethernet WAN mode.
	Red	On	Internet connection is unavailable.
WiFi/WPS	Green	On	WiFi is enabled.
		Blinking	WPS is activated, and the Zyxel Device is establishing a WPS connection.
		Off	WiFi is disabled.

Table 7 NR5103E LED Behavior

LED	COLOR	STATUS	DESCRIPTION
Power	Green	On	The Zyxel Device is receiving power and ready for use.
		Blinking	The Zyxel Device is booting.
		Off	The Zyxel Device is not receiving power.
	Red	On	Zyxel Device error, need to take action.
SMS	Green	On	There is a new SMS message.
		Blinking	The Inbox is full.
		Off	There is no unread SMS message.
Cellular Signal Strength	Blue	On	The signal strength is good.
		Blinking	No SIM card or invalid SIM card.
	Green	On	The signal strength is medium.
		Red	On
Blinking	There is no cellular signal, or signal strength is below the poor level.		
Internet	Blue	On	The Zyxel Device is connected to the Internet using 5G.
	Green	On	The Zyxel Device is connected to the Internet using 4G, or is connected in Ethernet WAN mode.
	Red	On	Internet connection is unavailable.
WiFi/WPS	Green	On	WiFi is enabled.
		Blinking	WPS is activated, and the Zyxel Device is establishing a WPS connection.
		Off	WiFi is disabled.

**Figure 18** NR5103EV2 / NR5103EV3 LEDs

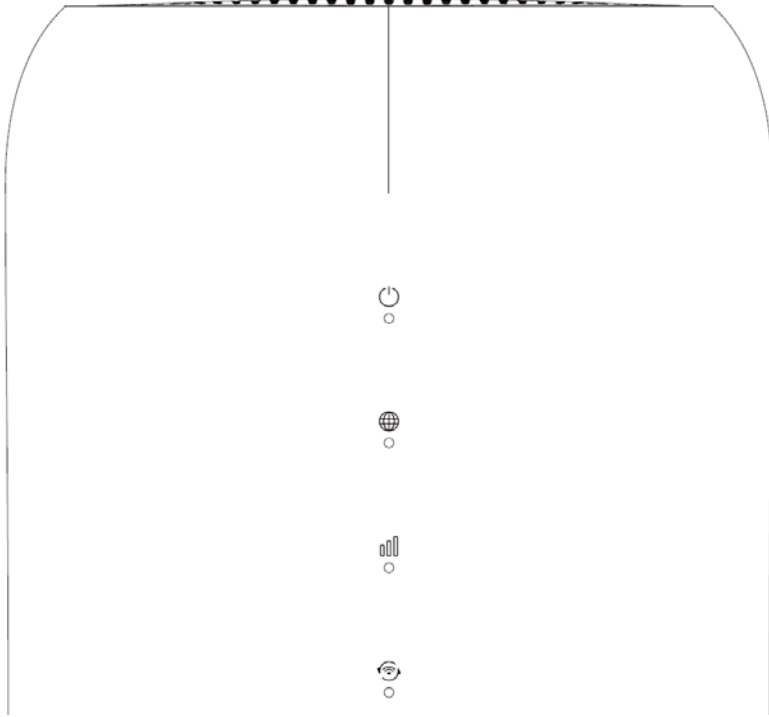

Figure 19 NR5307 LEDs

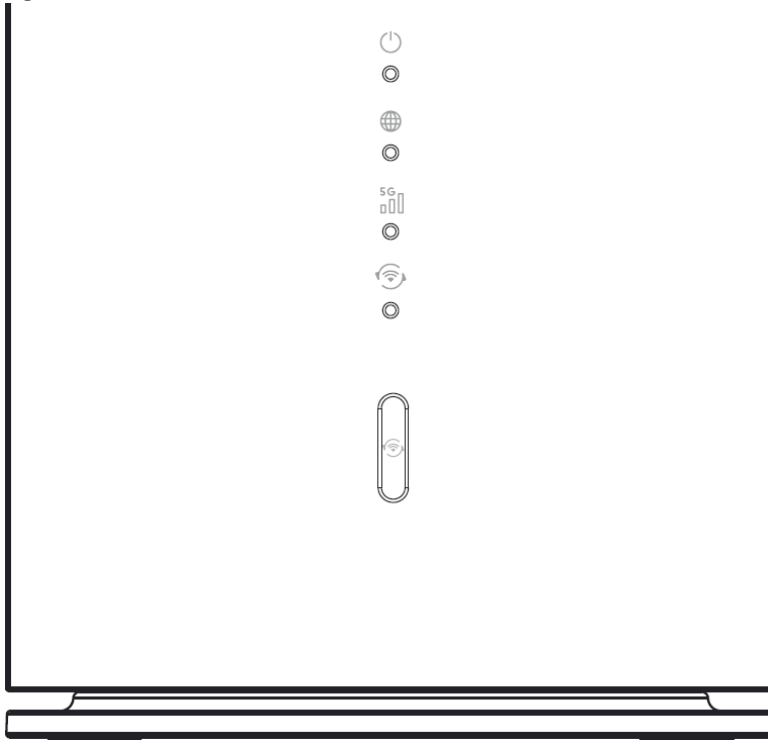

Table 8 NR5103EV2 / NR5103EV3 / NR5307 LED Behavior

LED	COLOR	STATUS	DESCRIPTION
Power/System	Blue	On	There is a new SMS message.
		Blinking	The Inbox is full.
	Green	On	The Zyxel Device is receiving power and ready for use.
		Blinking	The Zyxel Device is booting.
		Intermittent On	The Zyxel Device is in power-saving mode.
	Red	Off	The Zyxel Device is not receiving power.
Internet	Blue	On	Zyxel Device error, need to take action.
	Blue	On	The Zyxel Device is connected to the Internet using 5G.
	Green	On	The Zyxel Device is connected to the Internet using 4G, or is connected in Ethernet WAN mode.
Cellular Signal Strength	Red	On	Internet connection is unavailable.
		Blinking	No SIM card or invalid SIM card.
	Blue	On	The signal strength is good.
	Green	On	The signal strength is medium.
WiFi/WPS	Red	On	The signal strength is poor.
		Blinking	WiFi is enabled.
	Green	Off	WiFi is disabled.
Off	Blinking	WPS is activated, and the Zyxel Device is establishing a WPS connection.	
All LEDs	Green	Blinking	WiFi is disabled.
			The Zyxel Device is resetting to factory default settings or upgrading firmware.



## 2.3 SIM Card Slot

The following figures show the Micro-SIM card slot on the Zyxel Device. Insert your SIM card provided by your Internet Service Provider (ISP). Refer to the QSG for more information on hardware installations.

**Figure 20** NR5101 Micro SIM Card Slot

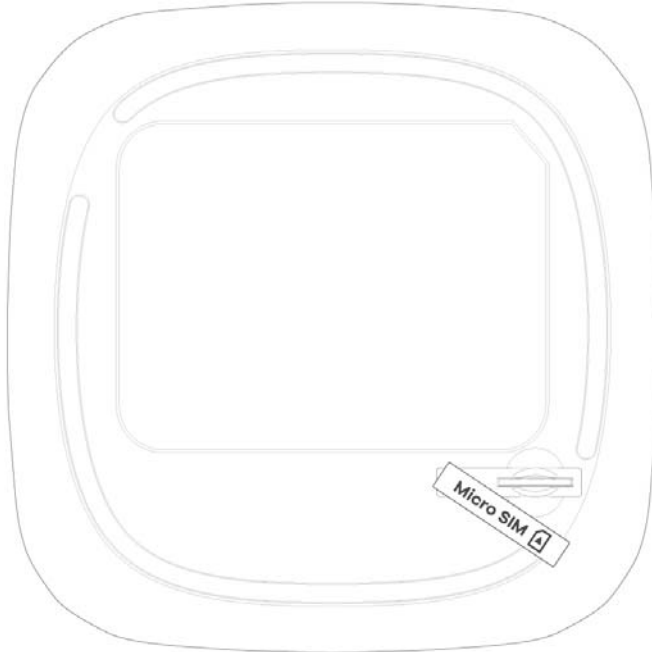

**Figure 21** NR5103 / NR5103E / FWA510 Micro SIM Card Slot



Figure 22 NR5103EV2 / NR5103EV3 Micro SIM Card Slot

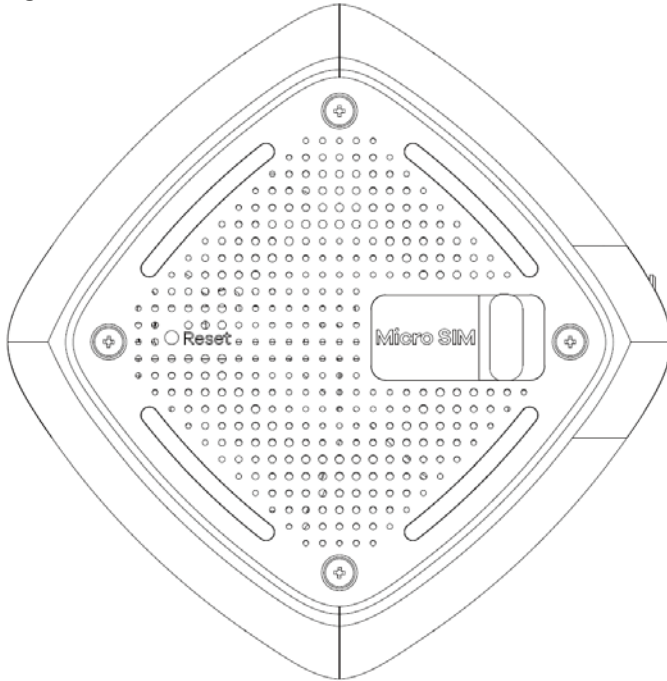
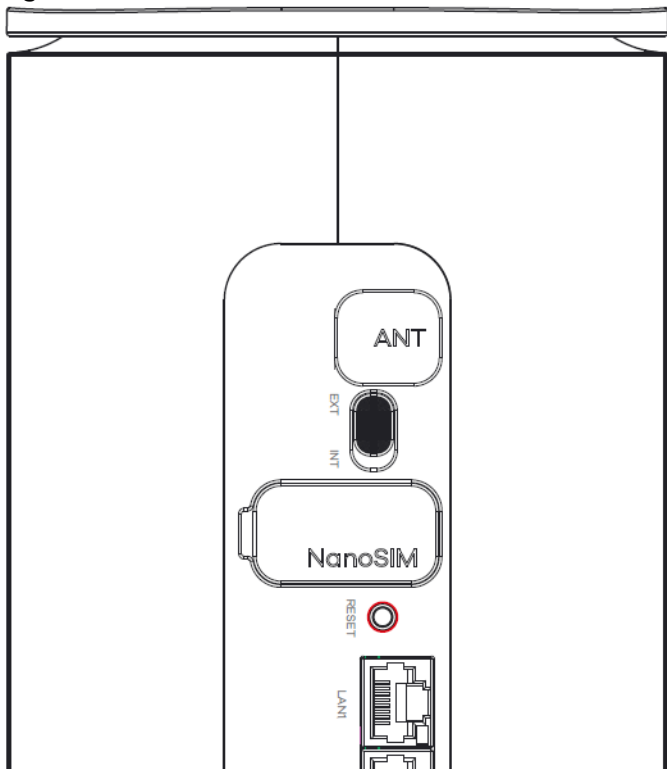

Figure 23 NR5307 Nano SIM Card Slot



## 2.4 External Antenna Connector

The following figures show the external antenna connectors on the Zyxel Device.

Figure 24 NR5103 / NR5103E / FWA510 External Antenna Connectors

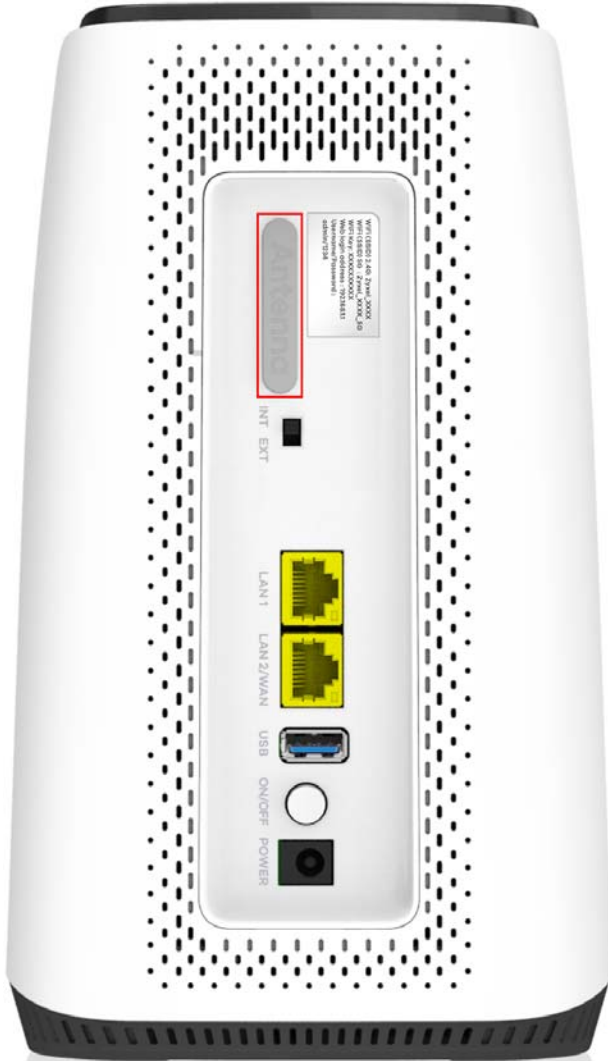
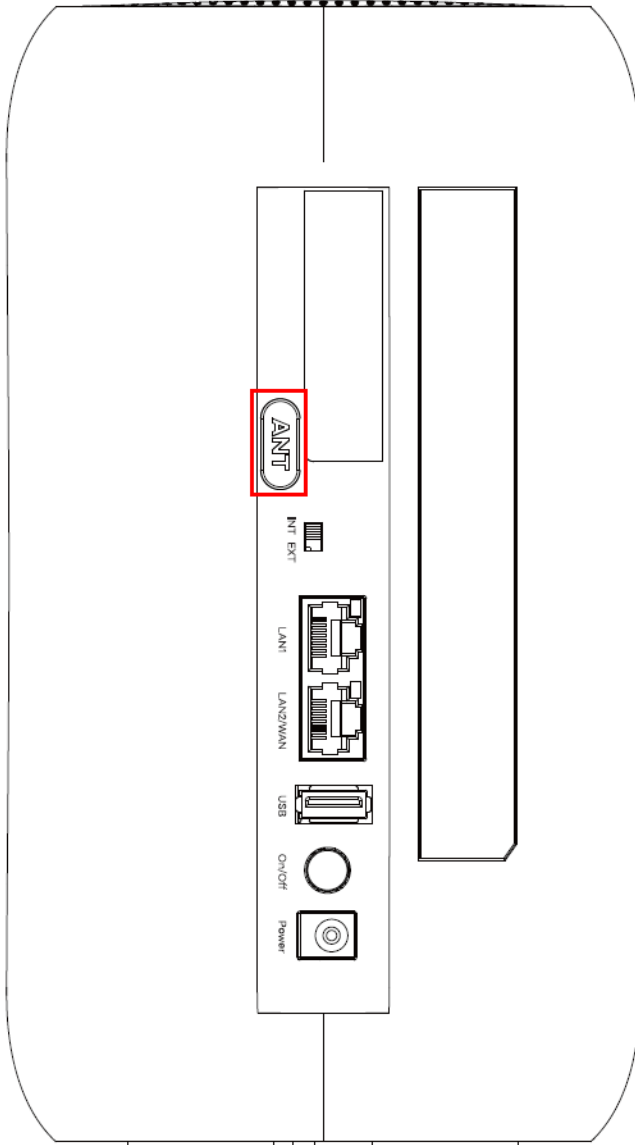
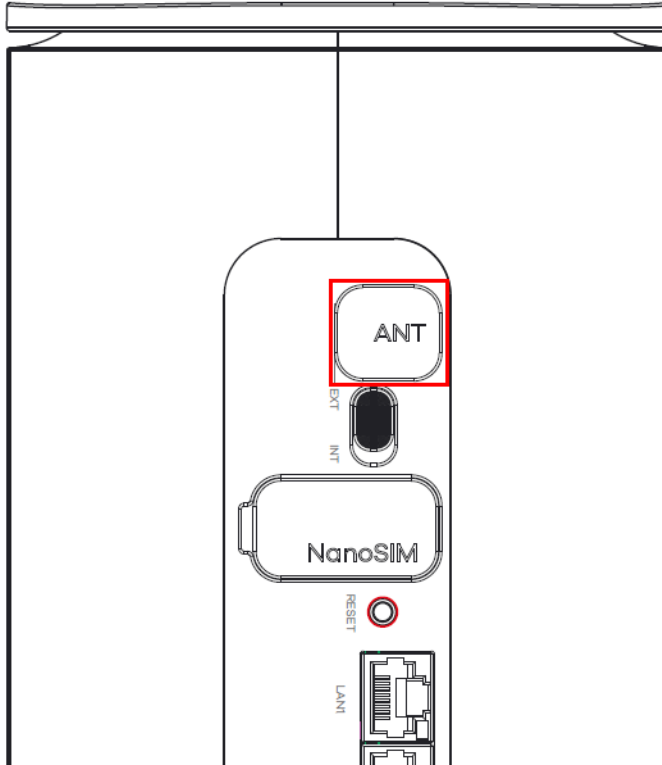

Figure 25 NR5103EV2 / NR5103EV3 External Antenna Connectors



**Figure 26** NR5307 External Antenna Connectors

To install the external antennas on the Zyxel Device, do the following:

- 1 Remove the external antenna cover (**Antenna / ANT**).
- 2 Install a TS9 to SMA type adapter to the external antenna connectors.
- 3 Install the external antennas.
- 4 Set the **INT/EXT / INT EXT / EXT INT** switch to **EXT**.
- 5 Position the external antenna to find the optimal 5G NR signal strength.

## 2.5 Ports and Buttons

The following figures show the ports and buttons on the Zyxel Device.

Figure 27 NR5101 Ports and Buttons

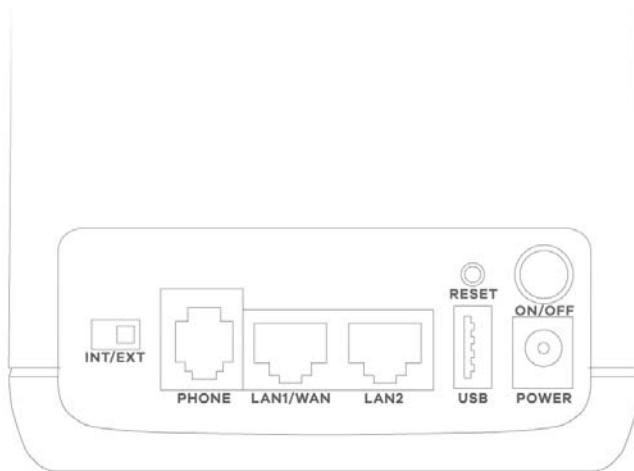

The following table describes the ports and buttons on the Zyxel Device.

Table 9 NR5101 Ports and Buttons

LABELS	DESCRIPTION
ANT1-ANT2/Antenna	Install the external antennas to strengthen the cellular signal.  Note: To use the external antennas, you must set the <b>INT/EXT</b> switch to <b>EXT</b> .
USB	The USB port of the Zyxel Device is used for file sharing.
LAN1/WAN	LAN mode: Connect a computer to the LAN using an RJ45 cable.  WAN mode: Connect the Zyxel Device to the Internet through the WAN.
LAN2	Connect a computer to the LAN using an RJ45 cable.
WiFi/WPS	Press the WiFi/WPS button to activate WPS connection process or enable WiFi. See <a href="#">Table 12 on page 42</a> for more information.
RESET	Press the <b>RESET</b> button to reboot or reset the Zyxel Device. See <a href="#">Table 13 on page 45</a> for more information.
ON/OFF	Press the <b>ON/OFF</b> button after the power adapter is connected to start the Zyxel Device.
POWER	Connect the power adapter and press the <b>ON/OFF</b> button to start the Zyxel Device.
Micro SIM	Insert a Micro-SIM card into the slot with the chip facing down and the beveled corner in the top left corner.
PHONE	Connect a phone device for VoIP or VoLTE calls.
INT/EXT	Select between the internal or external cellular antennas.

Figure 28 NR5103 / NR5103E / FWA510 Ports and Buttons

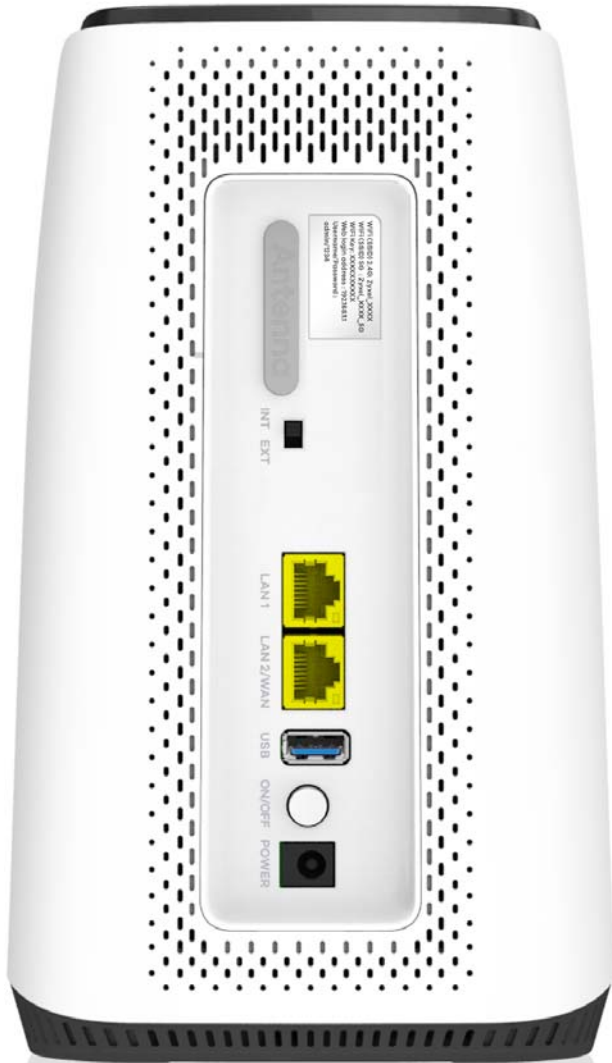
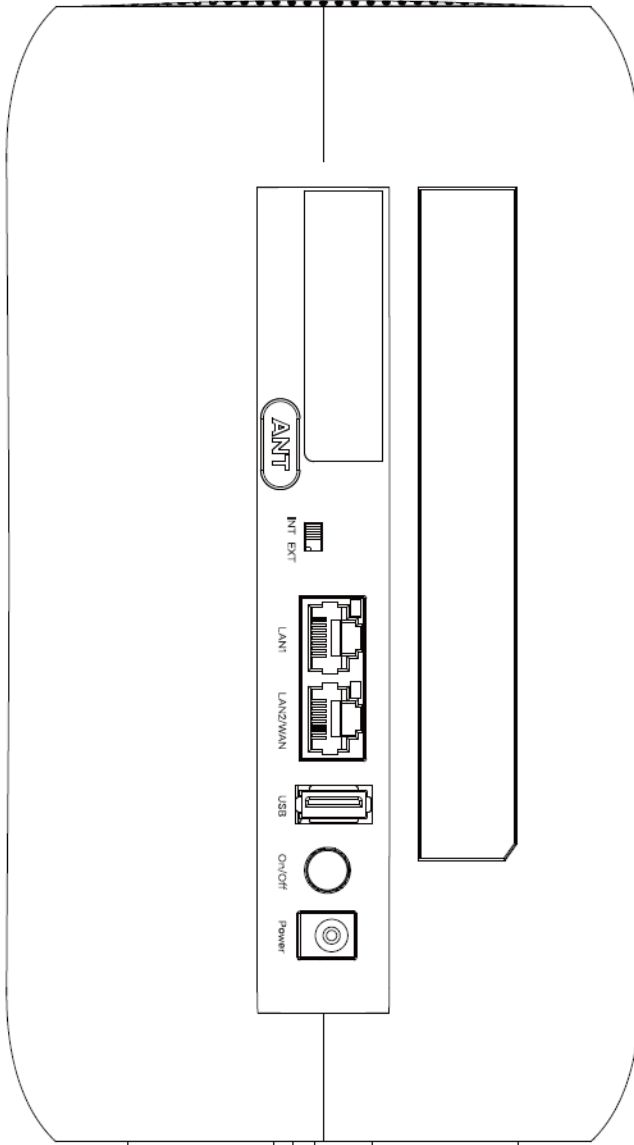

Figure 29 NR5103EV2 / NR5103EV3 Ports and Buttons



The following table describes the ports and buttons on the Zyxel Device.

Table 10 NR5103 / NR5103E / NR5103EV2 / NR5103EV3 / FWA510 Ports and Buttons

LABELS	DESCRIPTION
ANT1-ANT2 / Antenna / ANT	Install the external antennas to strengthen the cellular signal.  Note: To use the external antennas, you must set the <b>INT EXT</b> switch to <b>EXT</b> .
INT EXT	Select between the internal or external cellular antennas.
LAN1	Connect a computer to the LAN using an RJ45 cable.
LAN2/WAN	LAN mode: Connect a computer to the LAN using an RJ45 cable.  WAN mode: Connect the Zyxel Device to the Internet through the WAN.
USB	The USB port of the Zyxel Device is used for file sharing.
On/Off	Press the <b>On/Off</b> button after the power adapter is connected to start the Zyxel Device.



Table 10 NR5103 / NR5103E / NR5103EV2 / NR5103EV3 / FWA510 Ports and Buttons (continued)

LABELS	DESCRIPTION
Power	Connect the power adapter and press the <b>On/Off</b> button to start the Zyxel Device.
WiFi/WPS	Press the WiFi/WPS button to activate WPS connection process. See <a href="#">Table 12 on page 42</a> for more information.
Reset	Press the <b>Reset</b> button to reboot or reset the Zyxel Device. See <a href="#">Table 13 on page 45</a> for more information.
Micro SIM	Insert a Micro-SIM card into the slot with the chip facing down and the beveled corner in the top left corner.

Figure 30 NR5307 Ports and Buttons

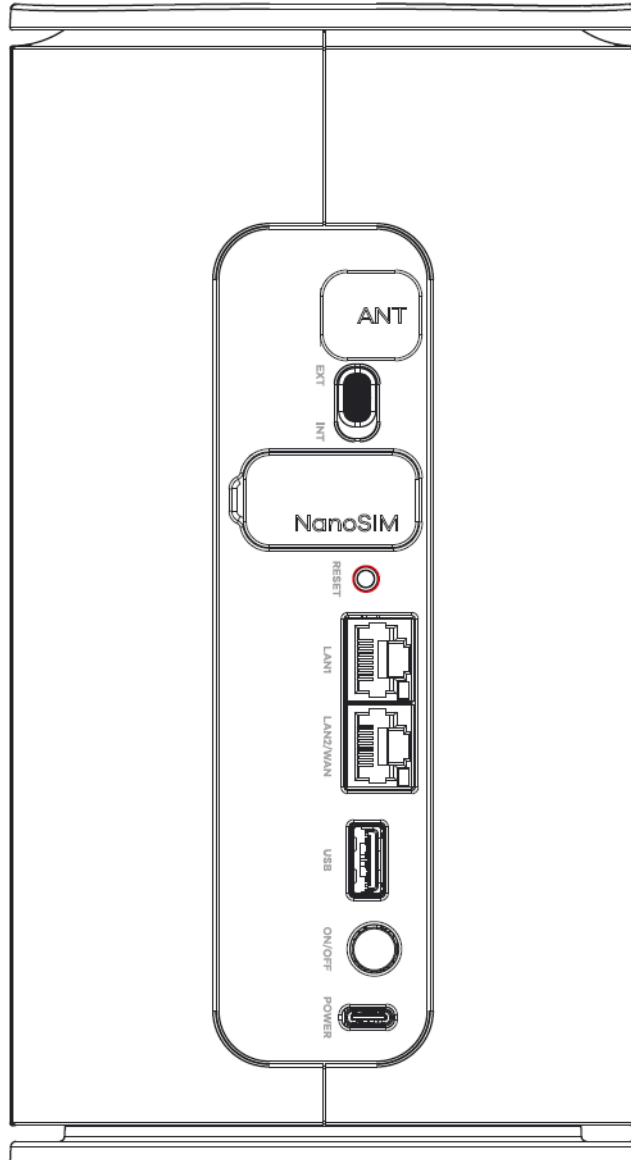

The following table describes the ports and buttons on the Zyxel Device.

Table 11 NR5307 Ports and Buttons

LABELS	DESCRIPTION
ANT	Install the external antennas to strengthen the cellular signal.  Note: To use the external antennas, you must set the <b>EXT INT</b> switch to <b>EXT</b> .
EXT INT	Select between the external or internal cellular antennas.
Nano SIM	Place a nano SIM card on the nano SIM card tray and insert into the slot with the chip facing up and the beveled corner in the top right corner.
RESET	Press the <b>RESET</b> button to reboot or reset the Zyxel Device. See <a href="#">Table 13 on page 45</a> for more information.
LAN1	Connect a computer to the LAN using an RJ45 cable.
LAN2/WAN	LAN mode: Connect a computer to the LAN using an RJ45 cable.  WAN mode: Connect the Zyxel Device to the Internet through the WAN.
USB	The USB port of the Zyxel Device is used for file sharing.
ON/OFF	Press the <b>ON/OFF</b> button after the power adapter is connected to start the Zyxel Device.
POWER	Connect the power adapter and press the <b>ON/OFF</b> button to start the Zyxel Device.
WiFi/WPS	Press the WiFi/WPS button to activate WPS connection process. See <a href="#">Table 12 on page 42</a> for more information.

## 2.6 How to Enable WiFi/WPS

The following table shows the functions of the WiFi/WPS button.

Table 12 How to enable WiFi and WPS

WiFi/WPS BUTTON	FUNCTION	NR5101	NR5103/ NR5103E	NR5103EV2/ NR5103EV3	NR5307	FWA510
WiFi	Turn on WiFi	Press for 1 second	N/A	N/A	Press for at least 10 seconds	N/A
WPS	Activate WPS	Press for at least 5 seconds	Press for at least 3 seconds	Press for at least 3 seconds	Press for at least 3 seconds	Press for at least 3 seconds

### 2.6.1 NR5101 WiFi/WPS Button

The following figure shows the WiFi/WPS button on the Zyxel Device.

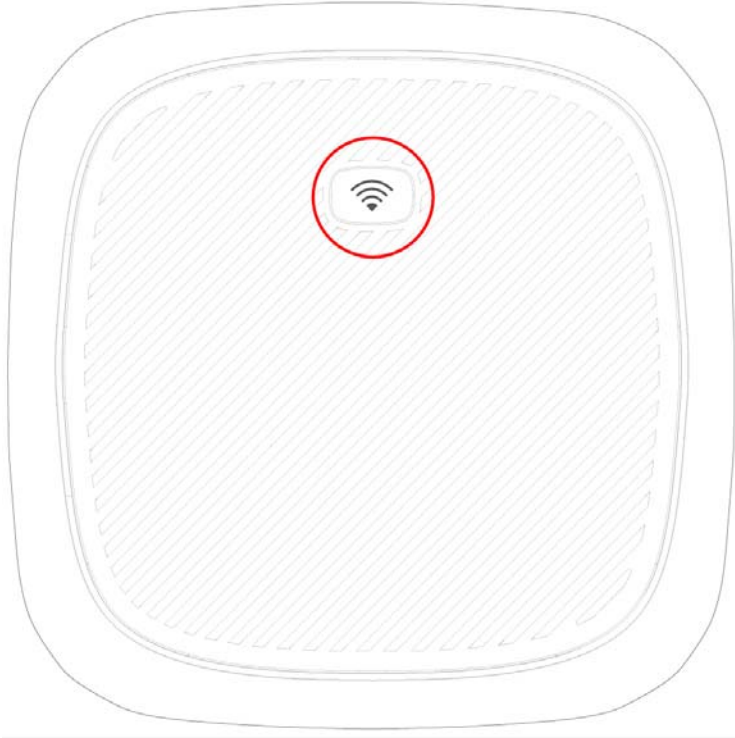
**Figure 31** NR5101 WiFi/WPS Button

### Turning on WiFi

Press the WiFi/WPS button on the Zyxel Device and then release it.

After WiFi is turned on, the LED lights green.

### Activating WPS

You can also quickly set up a secure WiFi connection between the Zyxel Device and a WPS-compatible client by adding one device at a time.

- 1 Ensure WiFi is turned on.
- 2 Press the WiFi/WPS button and release it to enable WPS.
- 3 Press the WPS button on another WPS-enabled device that is within range of the Zyxel Device within 120 seconds.

After a WiFi connection is established, the WiFi/WPS LED blinks slowly green.

## 2.6.2 NR5103 / NR5103E / NR5103EV2 / NR5103EV3 / FWA510 WiFi/WPS Button

The following figure shows the WiFi/WPS button on the Zyxel Device.

**Figure 32** NR5103 / NR5103E / FWA510 WiFi/WPS Button



**Figure 33** NR5103EV2 / NR5103EV3 WiFi/WPS Button

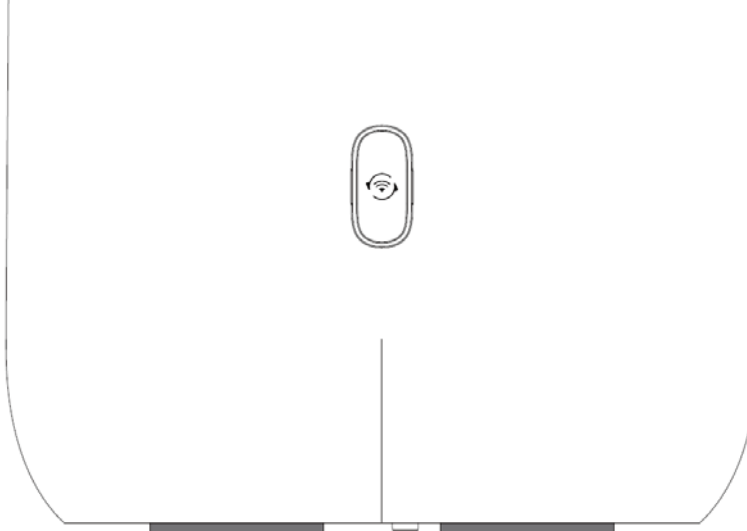

**Figure 34** NR5307 WiFi/WPS Button

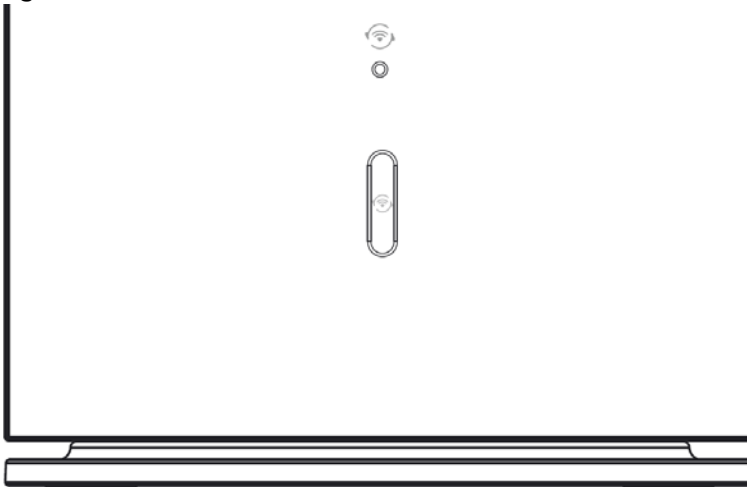

## Turning on WiFi (for NR5103EV2 / NR5103EV3 / NR5307)

Press the WiFi/WPS button more than 10 seconds on the Zyxel Device and then release it.

After WiFi is turned on, the LED lights green.

## Activating WPS

You can also quickly set up a secure WiFi connection between the Zyxel Device and a WPS-compatible client by adding one device at a time.

- 1 Ensure WiFi is turned on.
- 2 Press the WiFi/WPS button and release it to enable WPS.
- 3 Press the WPS button on another WPS-enabled device that is within range of the Zyxel Device within 120 seconds.

After a WiFi connection is established, the WiFi/WPS LED blinks green.

## 2.7 How to Reset the Zyxel Device

Insert a thin object into the **RESET** hole of the Zyxel Device to reload the factory-default configuration file if you forget your password or IP address, or you cannot access the Web Configurator. This means that you will lose all configurations that you had previously saved. The password will be reset to the default (see the Zyxel Device label) and the IP address will be reset to **192.168.1.1**.

The following table shows the functions of the **RESET** button.

Table 13 How to Reset the Zyxel Device

RESET BUTTON	FUNCTION	NR5101	NR5103	NR5103E / NR5103EV2 / NR5103EV3	NR5307	FWA510
RESET	Reset the Zyxel Device	Press for at least 5 seconds	Press for at least 5 seconds	Press for at least 5 seconds	Press for at least 5 seconds	Press for at least 5 seconds
RESET	Reboot the Zyxel Device	Press for 2-5 seconds	Press for 2-5 seconds	Press for 2-5 seconds	Not available	Press for 2-5 seconds

The following figure shows the **RESET** button on the Zyxel Device.

Figure 35 NR5101 RESET Button

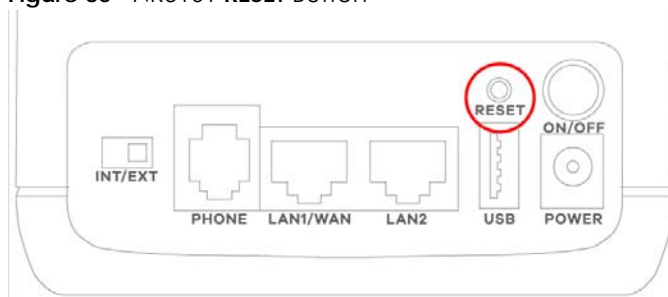
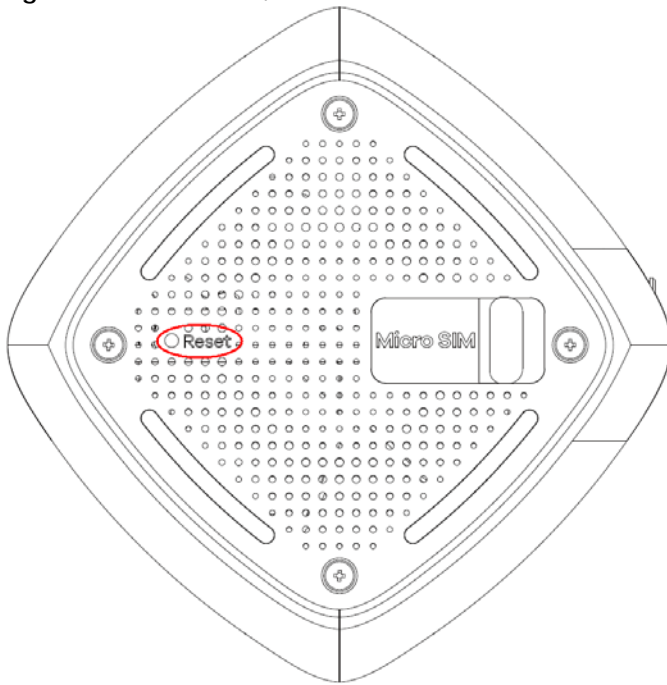

Figure 36 NR5103 / NR5103E / FWA510 RESET Button



Figure 37 NR5103EV2 / NR5103EV3 Reset Button



**Figure 38** NR5307 Reset Button

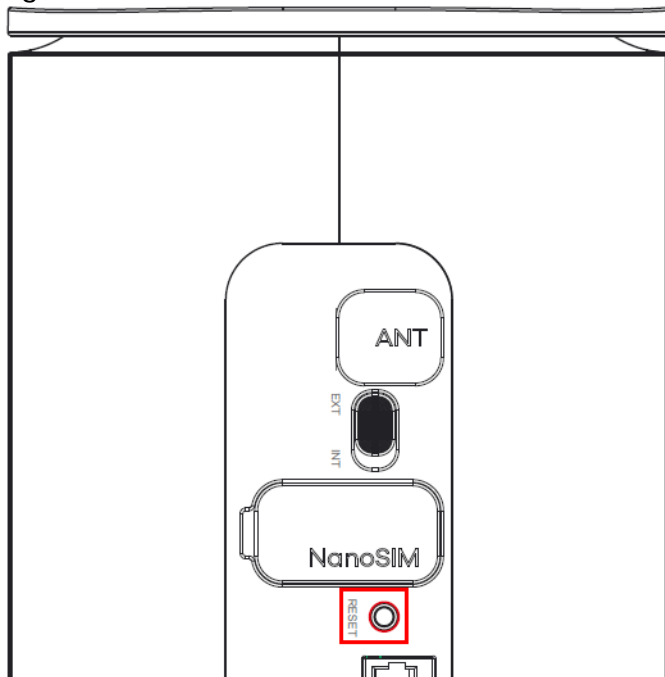

- 1 Make sure the Zyxel Device is connected to power and the POWER LED is on.
- 2 Using a thin object, press the **RESET** button.

# CHAPTER 3

## Web Configurator

### 3.1 Overview

The Web Configurator is an HTML-based management interface that allows easy system setup and management through Internet browser. Use a browser that supports HTML5, such as Microsoft Edge, Mozilla Firefox, or Google Chrome. The recommended minimum screen resolution is 1024 by 768 pixels.

In order to use the Web Configurator you need to allow:

- Web browser pop-up windows from your computer.
- JavaScript (enabled by default).
- Java permissions (enabled by default).

#### 3.1.1 Access the Web Configurator

- 1 Make sure your Zyxel Device hardware is properly connected (refer to the Quick Start Guide).
- 2 Make sure your computer has an IP address in the same subnet as the Zyxel Device.
- 3 Launch your web browser. Type `https://192.168.1.1` in your browser address bar.
- 4 If a "Your connection is not private" message appears, click **Advanced**, then click **Proceed to 192.168.1.1(unsafe)** to go to the login screen.

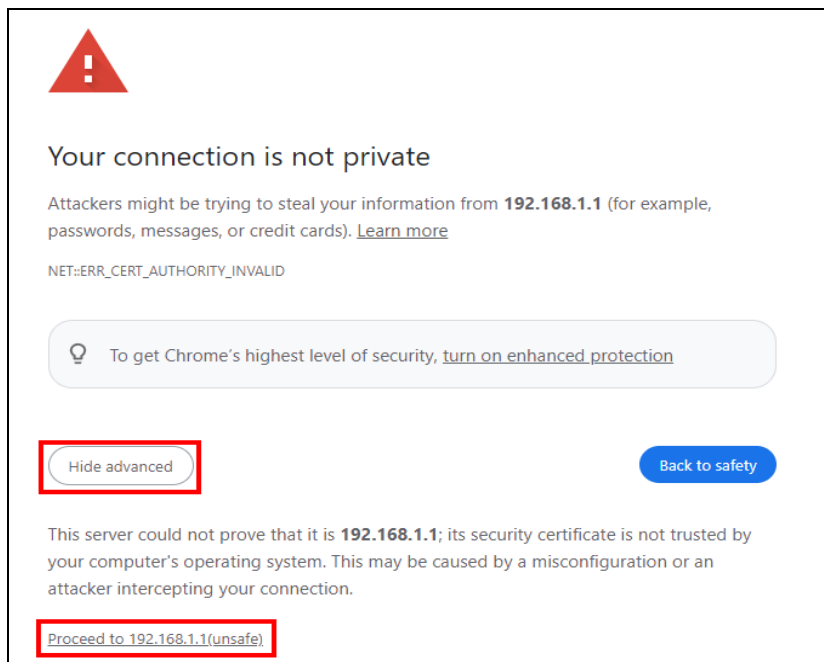



Note: If you see this warning page, it indicates that your browser has failed to verify the Secure Sockets Layer (SSL) certificate, which opens an encrypted connection. You can ignore this message and proceed to 192.168.1.1.

- 5 A login screen displays. Select the language you prefer (upper right).

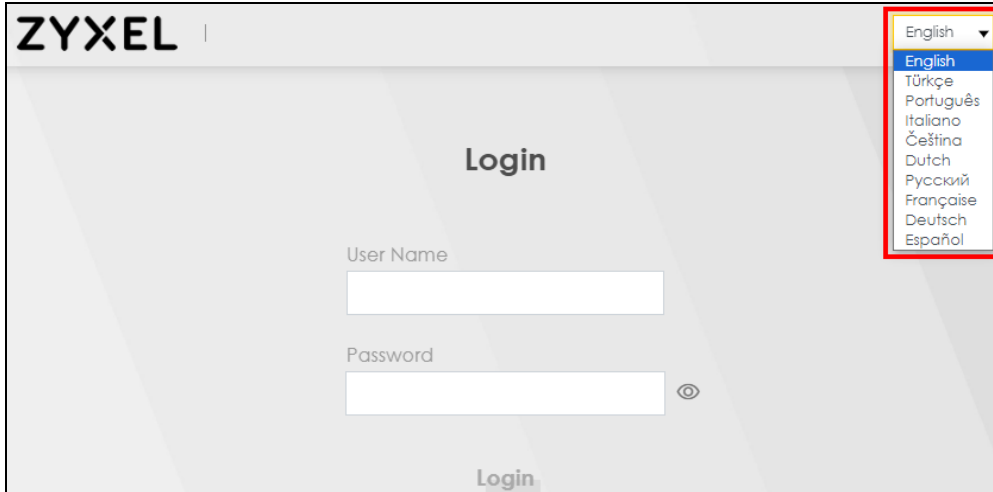

- 6 To access the administrative Web Configurator and manage the Zyxel Device, enter the default user name **admin** and the randomly assigned default password (see the Zyxel Device label) in the **Login** screen and click **Login**. If you have changed the password, enter your password and click **Login**.

**Figure 39** Login Screen

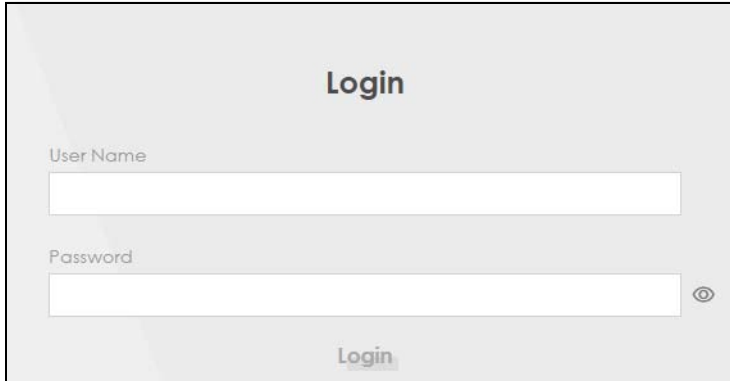

Note: The first time you enter the password, you will be asked to change it. Make sure the new password must be at least 8 characters, must contain at least one uppercase letter, one lowercase letter, one number, and one special character. For some models, the password must contain at least one English character and one number. Please see the password requirement displayed on the screen.

Figure 40 Change Password Screen

**Password Reset**

New Password

.....

Password

.....

The password must be at least 8 characters long, including 1 uppercase letter, 1 lowercase letter, 1 number and 1 special character.

**Change password**

- 7 The **Connection Status** screen appears. Use this screen to configure basic Internet access and WiFi settings.

## 3.2 Web Configurator Layout

As illustrated above, the main screen is divided into these parts:

- **A** – Settings Icon (Navigation Panel and Side Bar)
- **B** – Layout Icon
- **C** – Main Window

### 3.2.1 Settings Icon

Click this icon () to see the side bar and navigation panel.

#### 3.2.1.1 Side Bar





The side bar provides some icons on the right hand side.

**Figure 41** Side Bar

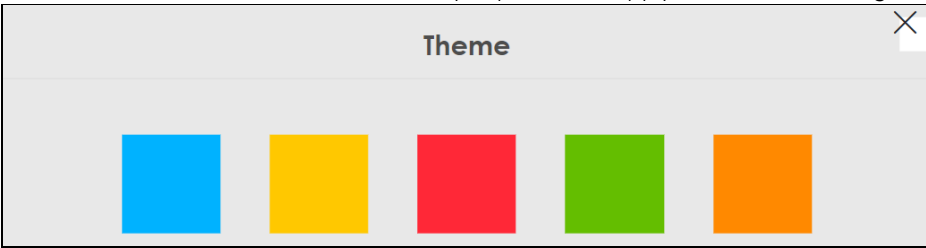

The icons provide the following functions.

**Table 14** Web Configurator Icons in the Title Bar

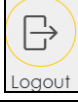
ICON	DESCRIPTION
	<b>Wizard:</b> Click this icon to open screens where you can configure the Zyxel Device's time zone and WiFi settings.
	<b>Theme:</b> Click this icon to select a color that you prefer and apply it to the Web Configurator. 
	<b>Language:</b> Select the language you prefer.
	<b>Restart:</b> Click this icon to reboot the Zyxel Device without turning the power off.
	<b>Logout:</b> Click this icon to log out of the Web Configurator.

### 3.2.1.2 Navigation Panel

Click the menu icon () to display the navigation panel that contains configuration menus and icons (quick links). Click **X** to close the navigation panel.

Use the menu items on the navigation panel to open screens to configure Zyxel Device features. The following tables describe each menu item.

**Figure 42** Navigation Panel

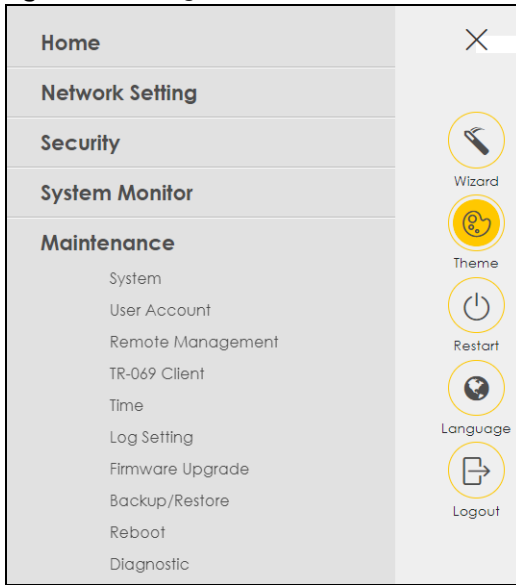

**Table 15** Navigation Panel Summary

LINK	TAB	FUNCTION
Home		Use this screen to configure basic Internet access and wireless settings. This screen also shows the network status of the Zyxel Device and computers/devices connected to it.
Network Setting		
Broadband	Broadband	Use this screen to view and configure ISP parameters, WAN IP address assignment, and other advanced properties. You can also add new WAN connections.
	WAN Backup	Use this screen to configure your Zyxel Device's Internet settings if the cellular connection is down.
	Ethernet WAN	Use this screen to convert the LAN port as WAN port, or restore the WAN port to LAN port.
	Cellular WAN	Use this screen to configure a cellular WAN connection.
	Cellular APN	Use this screen to configure the Access Point Name (APN) provided by your service provider.
	Cellular SIM	Use this screen to enter a PIN for your SIM card to prevent others from using it.
	Cellular Band	Use this screen to configure the cellular frequency bands that can be used for Internet access as provided by your service provider.
	Cellular PLMN	Use this screen to view available PLMNs and select your preferred network.
	Cellular IP Passthrough	Use this screen to enable IP Passthrough on the Zyxel Device.
	Cellular Lock	Use this screen to enable or disable PCI Lock.
	Cellular SMS	Use this screen to enable SMS Inbox and receive SMS messages.
Wireless	General	Use this screen to configure the WiFi settings and WiFi authentication or security settings.
	Guest/More AP	Use this screen to configure multiple BSSs on the Zyxel Device.

Table 15 Navigation Panel Summary (continued)

LINK	TAB	FUNCTION
	MAC Authentication	Use this screen to block or allow wireless traffic from wireless devices of certain SSIDs and MAC addresses to the Zyxel Device.
	WPS	Use this screen to configure and view your WPS (WiFi Protected Setup) settings.
	WMM	Use this screen to enable or disable WiFi MultiMedia (WMM).
	Others	Use this screen to configure advanced WiFi settings.
	WLAN Scheduler	Use this screen to create rules to schedule the times to permit Internet traffic from each wireless network interfaces.
	Channel Status	Use this screen to scan WiFi channel noises and view the results.
	Easy Mesh	Use this screen to enable or disable Easy Mesh.
Home Networking	LAN Setup	Use this screen to configure LAN TCP/IP settings, and other advanced properties.
	Static DHCP	Use this screen to assign specific IP addresses to individual MAC addresses.
	UPnP	Use this screen to turn UPnP and UPnP NAT-T on or off.
Routing	Static Route	Use this screen to view and set up static routes on the Zyxel Device.
	DNS Route	Use this screen to forward DNS queries for certain domain names through a specific WAN interface to its DNS servers.
	RIP	Use this screen to configure Routing Information Protocol to exchange routing information with other routers.
NAT	Port Forwarding	Use this screen to make your local servers visible to the outside world.
	Port Triggering	Use this screen to change your Zyxel Device's port triggering settings.
	DMZ	Use this screen to configure a default server which receives packets from ports that are not specified in the <b>Port Forwarding</b> screen.
	ALG	Use this screen to enable the ALGs (Application Layer Gateways) in the Zyxel Device to allow applications to operate through NAT.
DNS	DNS Entry	Use this screen to view and configure DNS routes.
USB	USB Service	Use this screen to enable file sharing through the Zyxel Device.
Security		
Firewall	General	Use this screen to configure the security level of your firewall.
	Protocol	Use this screen to add Internet services and configure firewall rules.
	Access Control	Use this screen to enable specific traffic directions for network services.
	DoS	Use this screen to activate protection against Denial of Service (DoS) attacks.
MAC Filter	MAC Filter	Use this screen to block or allow traffic from devices of certain MAC addresses to the Zyxel Device.
Parental Control	Parental Control	Use this screen to define time periods and days during which the Zyxel Device performs parental control and/or block web sites with the specific URL.
Certificates	Local Certificates	Use this screen to view a summary list of certificates and manage certificates and certification requests.
	Trusted CA	Use this screen to view and manage the list of the trusted CAs.
Voice	Voice Mode	Use this screen to enable the Voice Mode on the Zyxel Device.
	SIP	Use this screen to set up information about your SIP account.
	Phone	Use this screen to change settings that depend on the country you are in.

Table 15 Navigation Panel Summary (continued)

LINK	TAB	FUNCTION
	Call Rule	Use this screen to add, edit, or remove speed-dial numbers for outgoing calls.
	Call History	Use this screen to view a call history list.
System Monitor		
Log	System Log	Use this screen to view the status of events that occurred to the Zyxel Device. You can export or email the logs.
	Security Log	Use this screen to view all security related events. You can select the level and category of the security events in their proper drop-down list window.  Levels include: <ul style="list-style-type: none"> <li>• Emergency</li> <li>• Alert</li> <li>• Critical</li> <li>• Error</li> <li>• Warning</li> <li>• Notice</li> <li>• Informational</li> <li>• Debugging</li> </ul> Categories include: <ul style="list-style-type: none"> <li>• Account</li> <li>• Attack</li> <li>• Firewall</li> <li>• MAC Filter</li> </ul>
Traffic Status	WAN	Use this screen to view the status of all network traffic going through the WAN port of the Zyxel Device.
	LAN	Use this screen to view the status of all network traffic going through the LAN ports of the Zyxel Device.
VoIP Status	VoIP Status	Use this screen to view VoIP registration, current call status and phone numbers for the phone ports.
ARP Table	ARP Table	Use this screen to view the ARP table. It displays the IP and MAC address of each DHCP connection.
Routing Table	Routing Table	Use this screen to view the routing table on the Zyxel Device.
WLAN Station Status	WLAN Station Status	Use this screen to view the wireless stations that are currently associated to the Zyxel Device's WiFi.
Cellular WAN Status	Cellular WAN Status	Use this screen to look at the cellular Internet connection status.
Maintenance		
System	System	Use this screen to set the Zyxel Device name and Domain name.
User Account	User Account	Use this screen to change the user password on the Zyxel Device.
Remote Management	MGMT Services	Use this screen to enable specific traffic directions for network services.
	MGMT Services for IP Passthrough	Use this screen to enable various approaches to access this Zyxel Device remotely from a WAN and/or LAN connection.
	Trust Domain	Use this screen to view a list of public IP addresses which are allowed to access the Zyxel Device through the services configured in the <b>Maintenance &gt; Remote Management &gt; MGMT Services</b> screen.
	Trust Domain for IP Passthrough	Use this screen to enable public IP addresses to access this Zyxel Device remotely from a WAN and/or LAN connection.

Table 15 Navigation Panel Summary (continued)

LINK	TAB	FUNCTION
TR-069 Client	TR-069 Client	Use this screen to configure your Zyxel Device to be managed remotely by an Auto Configuration Server (ACS) using TR-069.
Time	Time	Use this screen to change your Zyxel Device's time and date.
E-mail Notification	E-mail Notification	Use this screen to configure up to two mail servers and sender addresses on the Zyxel Device.
Log Setting	Log Settings	Use this screen to change your Zyxel Device's log settings.
Firmware Upgrade	Firmware Upgrade	Use this screen to upload firmware to your Zyxel Device.
	Online Upgrade	Use this screen to check for new firmware for your Zyxel Device online now or schedule a future check.
Backup/Restore	Backup/Restore	Use this screen to backup and restore your Zyxel Device's configuration (settings) or reset the factory default settings.
	Soft-Reset	Use this screen to keep specific configurations after resetting the Zyxel Device to the factory default settings.
Reboot	Reboot	Use this screen to reboot the Zyxel Device / Zyxel Mesh system without turning the power off.
Diagnostic	Ping&Traceroute &Nslookup	Use this screen to identify problems with the Zyxel Device. You can use Ping, TraceRoute, or Nslookup to help you identify problems.

### 3.2.1.3 Dashboard

Use the menu items in the navigation panel on the right to open screens to configure the Zyxel Device's features.

Figure 43 Navigation Panel

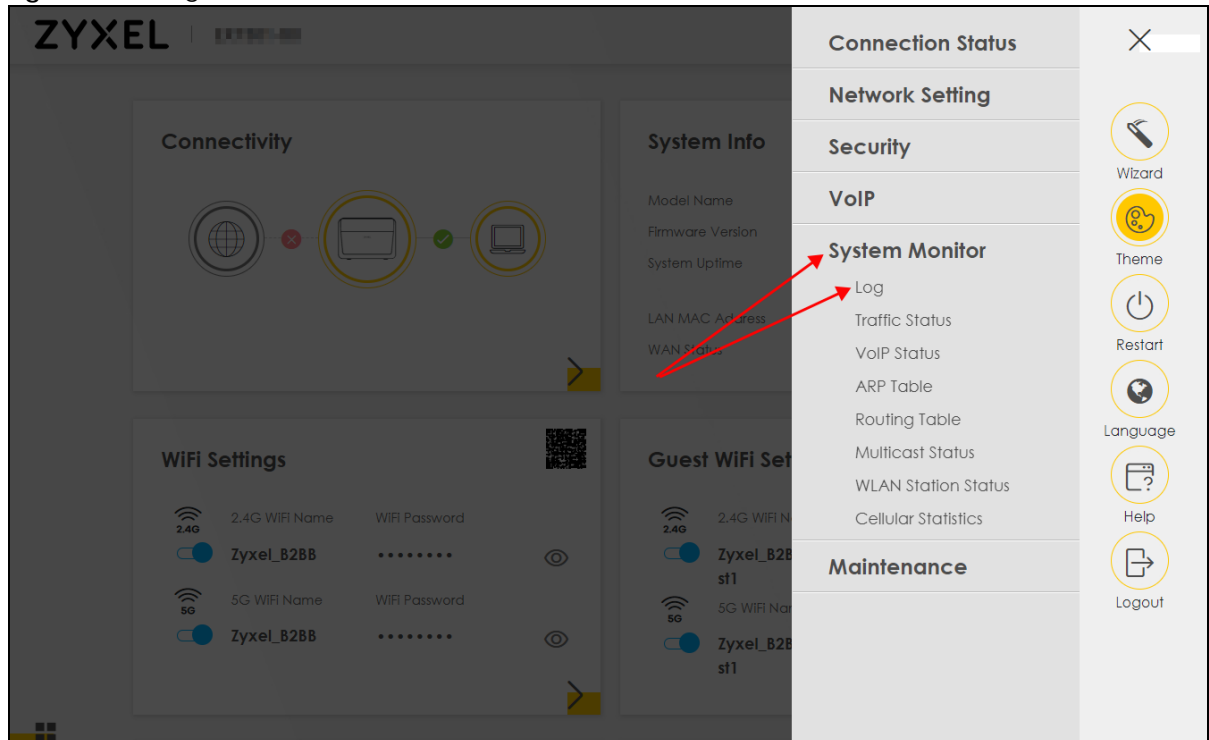

## 3.2.2 Widget Icon

Click the Widget icon (  ) in the lower left corner to arrange the screen order.

The following screen appears. Select a block and hold it to move around. Click the Check icon (  ) in the lower left corner to save the changes.

**Figure 44** Check Icon

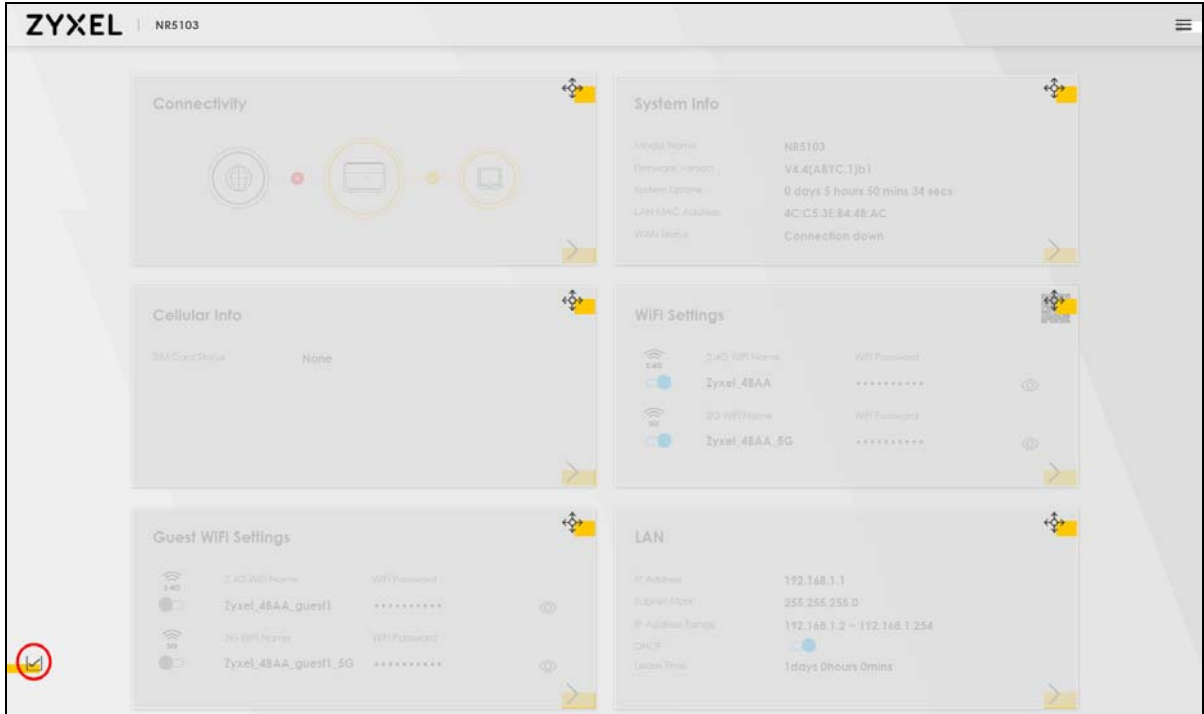



# CHAPTER 4

## Quick Start

### 4.1 Quick Start Overview

Use the **Wizard** screens to configure the Zyxel Device's time zone and WiFi settings.

Note: See the technical reference chapters for background information on the features in this chapter.

### 4.2 Quick Start Setup

You can click the **Wizard** icon in the side bar to open the **Wizard** screens. After you click the **Wizard** icon, the following screen appears. Click **Let's go** to proceed with settings on time zone and WiFi networks. It will take you a few minutes to complete the settings on the **Wizard** screens. You can click **Skip** to leave the **Wizard** screens.

Figure 45 Wizard – Home

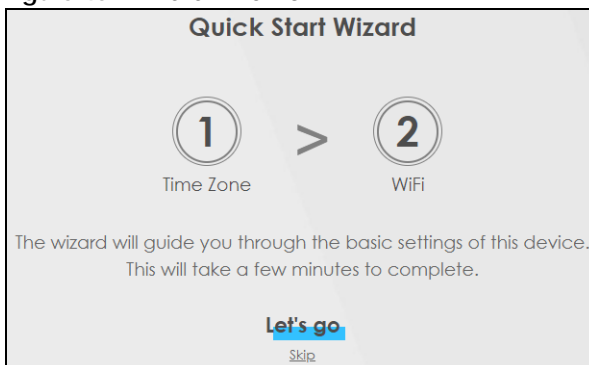

### 4.3 Quick Start Setup – Time Zone

Select the time zone of the Zyxel Device's location. Click **Next**.

Figure 46 Wizard – Time Zone

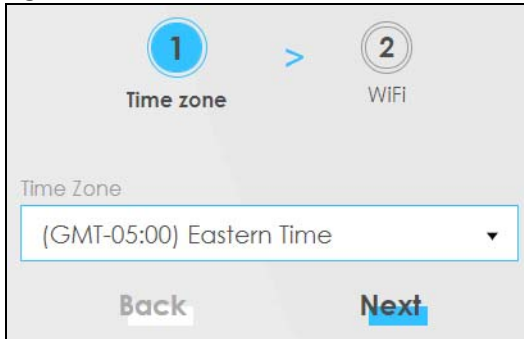

## 4.4 Quick Start Setup – WiFi

Turn WiFi on or off. If you keep it on, record the **WiFi Name** and **Password** in this screen so you can configure your WiFi clients to connect to the Zyxel Device. If you want to show or hide your WiFi password, click the Eye icon (👁).

Figure 47 Wizard – WiFi

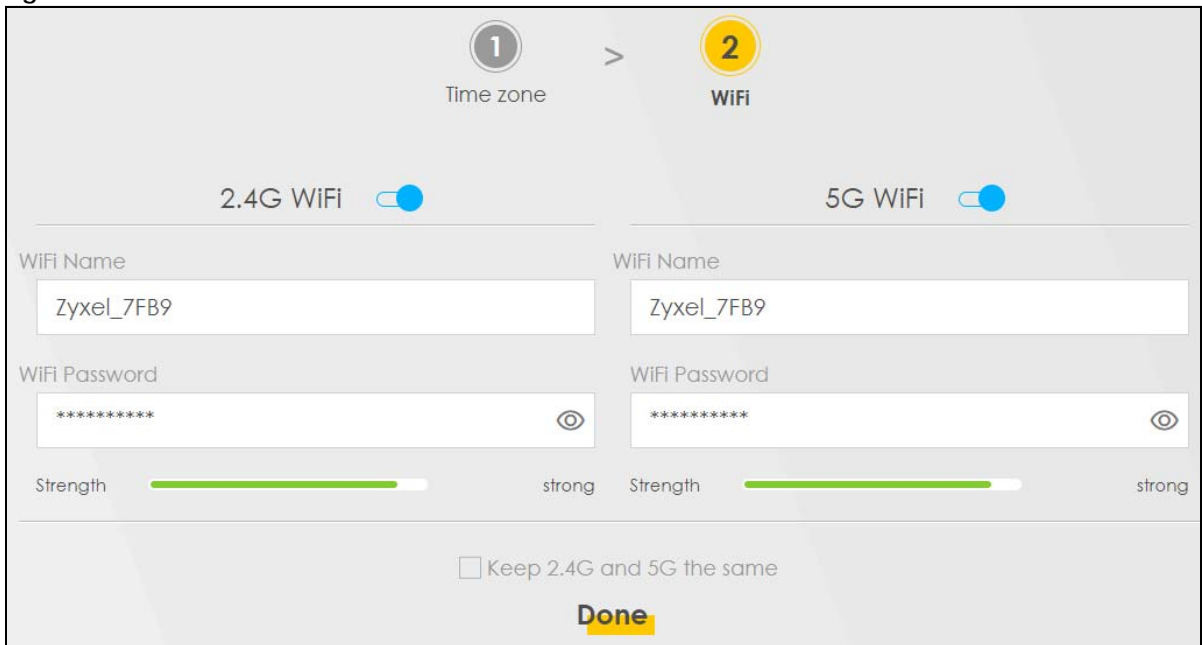

Note: You can also enable the WiFi service using any of the following methods:  
Click **Network Setting > Wireless** to open the **General** screen. Then select **Enable** in the **WiFi** field. Or, press the **WiFi** button.

## 4.5 Quick Start Setup – Finish

Your Zyxel Device saves and applies your settings.

# CHAPTER 5

## Web Interface Tutorials

### 5.1 Web Interface Overview

This chapter shows you how to use the Zyxel Device's various features.

- [Wired Network Setup](#)
- [WiFi Network Setup](#)
- [Cellular Network Setup](#)
- [USB Applications](#)
- [Network Security](#)
- [Internet Calls](#)
- [Device Maintenance](#)

### 5.2 Wired Network Setup

This section shows you how to set up a wired connection.

Set the Zyxel Device to **Routing** mode or **Bridge** mode on this connection as follows:

- Use **Routing** mode if you want the Zyxel Device to use routing mode functions such as **NAT**, **Firewall**, or **DHCP Server**. You will need to reconfigure your network if you have an existing router.
- Use **Bridge** mode to pass the ISP-assigned IP address(es) to your devices connected to the LAN port. All traffic from the Internet passes through the Zyxel Device directly to devices connected to the LAN port. Use this mode if you already have a router with complete routing functions in your network.

#### 5.2.1 Setting Up an Ethernet Connection

If you connect to the Internet through an Ethernet connection, you need to connect a broadband modem or router with Internet access to the WAN Ethernet port on the Zyxel Device. You need to configure the Internet settings from the broadband modem or router on the Zyxel Device. First, make sure you have Internet access through the broadband modem or router by connecting directly to it.

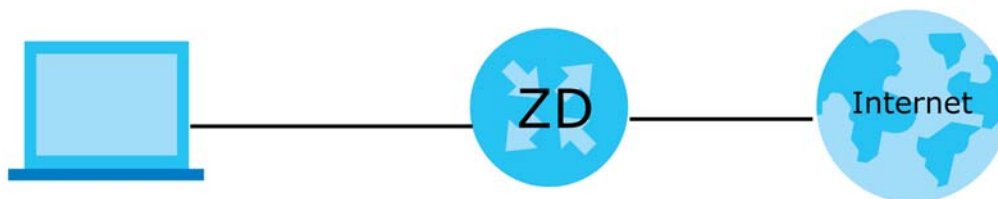

This example shows you how to configure an Ethernet WAN connection.

- 1 Make sure you have the Ethernet WAN port connect to a modem or router.
- 2 Go to **Network Setting > Broadband** and then the following screen appears. Click **Add New WAN Interface** to add a WAN connection.

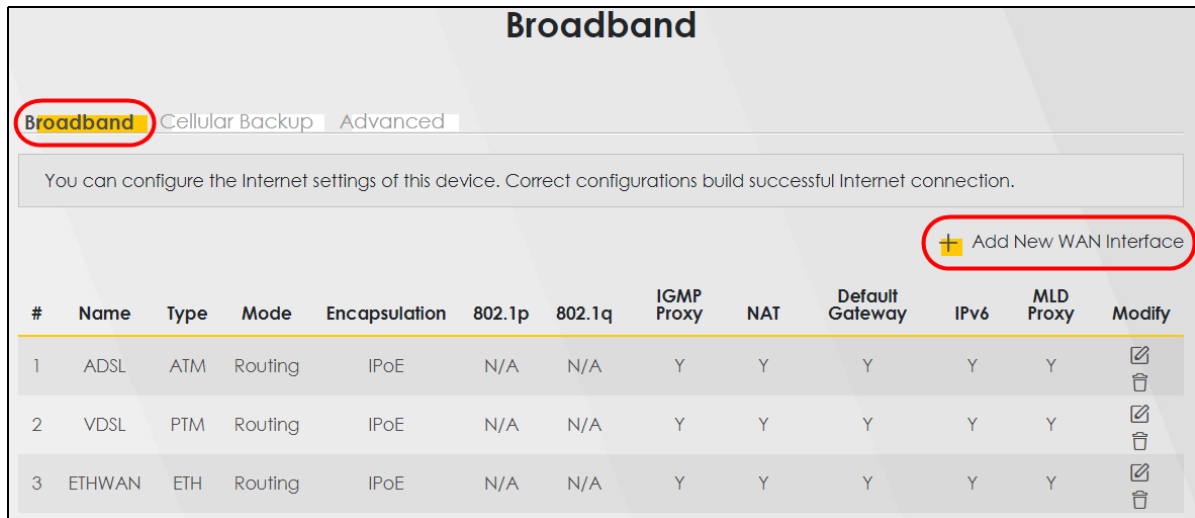

- 3 To set the Zyxel Device to **Routing** mode, see [Section on page 60](#).  
To set the Zyxel Device to **Bridge** mode, see [Section on page 62](#).

## Routing Mode

- 1 In this routing mode example, configure the following information for the Ethernet WAN connection.

General	
Name	My ETH Connecti
Type	Ethernet
Connection Mode	Routing
Encapsulation (Internet Type)	IPoE
IPv6/IPv4 Mode	IPv4 Only

- 2 Enter the **General** settings provided by your Internet service provider.
  - Enter a **Name** to identify your WAN connection.
  - Set the **Type** to **Ethernet**.
  - Set your Ethernet connection **Mode** to **Routing**.
  - Choose the **Encapsulation** specified by your Internet service provider. For this example, select **IPoE** as the WAN encapsulation type.
  - Set the **IPv4/IPv6 Mode** to **IPv4 Only**.
- 3 Under **Routing Feature**, enable **NAT** and **Apply as Default Gateway**.
- 4 For the rest of the fields, use the default settings.
- 5 Click **Apply** to save your settings.

<

## Add New WAN Interface

---

### General

Name

Type

Mode

Encapsulation

IPv4/IPv6 Mode

### VLAN

802.1p

802.1q  (0~4094)

### MTU

MTU

---

### IP Address

Obtain an IP Address Automatically

Static IP Address

### DNS Server

Obtain DNS Info Automatically

Use Following Static DNS Address

### Routing Feature

NAT  IGMP Proxy

Apply as Default Gateway  Fullcone NAT

6RD

---

### DHCP Options

Request Options

option 42     option 43     option 120     option 121

Sent Options

option 12

option 60

Vendor ID

option 61

IAID

DUID

option 125

Cancel
Apply



- 6** Go to the **Network Setting > Broadband** screen to view the established Ethernet connection. The new connection is displayed on the **Broadband** screen.

**Broadband**

**Broadband** Cellular Backup

Use this screen to change your Zyxel Device's Internet access settings. The summary table shows you the configured WAN services (connections) on the Zyxel Device. Use information provided by your ISP to configure WAN settings.

 Add New WAN Interface

#	Name	Type	Mode	Encapsulation	802.1p	802.1q	IGMP Proxy	NAT	Default Gateway	IPv6	MLD Proxy	Modify
1	My ETH Connecti	ETH	Routing	IPoE	N/A	N/A	Y	Y	Y	Y	N	 

## Bridge Mode

- 1 In this bridge mode example, configure the following information for the Ethernet WAN connection.

General	
Name	My ETH Connecti
Type	Ethernet
Connection Mode	Bridge

- 2 Enter the **General** settings provided by your Internet service provider.
  - Enter a **Name** to identify your WAN connection.
  - Set the **Type** to **Ethernet**.
  - Set your Ethernet connection **Mode** to **Bridge**.
- 3 For the rest of the fields, use the default settings.
- 4 Click **Apply** to save your settings.

**Edit WAN Interface**

**General**

Name:

Type:

Mode:

**VLAN**

802.1p:

802.1q:  (0~4094)

**MTU**

MTU:

## 5.3 WiFi Network Setup

In this example, you want to set up a WiFi network so that you can use your notebook to access the Internet. In this WiFi network, the Zyxel Device is an access point (AP), and the notebook is a WiFi client. The WiFi client can access the Internet through the AP.

**Figure 48** WiFi Network Setup

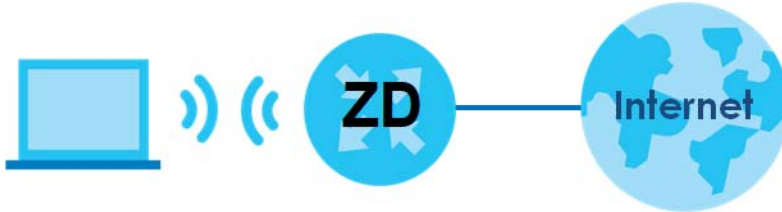

See the label on the Zyxel Device for the WiFi network settings and then connect manually to the Zyxel Device. Alternatively, you can connect to the Zyxel Device WiFi network using WPS. See [Section 5.3.3 on page 65](#).

### 5.3.1 Changing Security on a WiFi Network

This example changes the default security settings of a WiFi network to the following:

SSID	Example
Security Mode	WPA3-SAE/WPA2-PSK
Pre-Shared Key	DoNotStealMyWirelessNetwork
802.11 Mode	802.11b/g/n Mixed

- 1 Go to the **Network Setting > Wireless > General** screen. Select **More Secure** as the security level and **WPA3-SAE/WPA2-PSK** as the security mode. Configure the screen using the provided parameters. Click **Apply**.

A wireless network name (also known as SSID) and a security level are basic elements to start a wireless service. It is recommended to set a security level other than no security to protect your data from unauthorized access or damage via wireless network.

### Wireless

Wireless  Keep 2.4G and 5G wireless network name the same

### Wireless Network Setup

Band: 2.4GHz

Wireless:

Channel: Auto Current : 7 / 40 MHz

Bandwidth: 20MHz

Control Sideband: None

### Wireless Network Settings

Wireless Network Name: Example

Max. Clients: 32

Hide SSID ⓘ

Multicast Forwarding

Max. Upstream Bandwidth:

Max. Downstream Bandwidth:

Note

(1) Max. Upstream Bandwidth: This field allows you to configure the maximum bandwidth of this SSID to WAN.  
 (2) Max. Downstream Bandwidth: This field allows you to configure the maximum bandwidth of WAN to this SSID.  
 (3) If Max. Upstream/Downstream Bandwidth is empty, the CPE sets the value automatically.  
 (4) Using Max. Upstream/Downstream Bandwidth will significantly decrease the wireless performance.

BSSID: 5C:E2:8C:8A:F0:FD

### Security Level

No Security More Secure (Recommended)

WPA3-SAE/WPA2-PSK

Generate password automatically

Enter 8-63 ASCII characters or 64 hexadecimal digits ("0-9", "A-F").

Password: DoNotStealMyWirelessNetwork ⓘ

Encryption: AES

Timer: 3600 sec.

- Go to the **Wireless > Others** screen. Set **802.11 Mode** to **802.11b/g/n Mixed**, and then click **Apply**.



## Wireless

General
Guest/More AP
MAC Authentication
WPS
WMM
Others
Channel Status
MESH

The configurations below are the advanced wireless settings.

RTS/CTS Threshold	<input type="text" value="2347"/>	
Fragmentation Threshold	<input type="text" value="2346"/>	
Output Power	<input type="text" value="100%"/>	▼
Beacon Interval	<input type="text" value="100"/>	ms
DTIM Interval	<input type="text" value="1"/>	ms
802.11 Mode	<input type="text" value="802.11b/g/n Mixed"/>	▼
802.11 Protection	<input type="text" value="Auto"/>	▼
Preamble	<input type="text" value="Long"/>	
Protected Management Frames	<input type="text" value="Capable"/>	▼

Cancel
Apply

You can now use the WPS feature to establish a WiFi connection between your notebook and the Zyxel Device (see [Section 5.3.3 on page 65](#)). Now use the new security settings to connect to the Internet through the Zyxel Device using WiFi.

### 5.3.2 Connecting to the Zyxel Device's WiFi Network Using WPS

This section shows you how to connect a WiFi device to the Zyxel Device's WiFi network using WPS. WPS (Wi-Fi Protected Setup) is a security standard that allows devices to connect to a router securely without you having to enter a password. There are two methods:

- **Push Button Configuration (PBC)** – Connect to the WiFi network by pressing a button. This is the simplest method.
- **PIN Configuration** – Connect to the WiFi network by entering a PIN (Personal Identification Number) from a WiFi-enabled device in the Zyxel Device's Web Configurator. This is the more secure method, because one device can authenticate the other.

### 5.3.3 WPS Push Button Configuration (PBC)

This example shows how to connect to the Zyxel Device's WiFi network from a notebook computer running Windows 10.

- 1 Make sure that your Zyxel Device is turned on, and your notebook is within range of the Zyxel Device's WiFi signal.
- 2 Push and hold the **WPS** button located on the Zyxel Device until the **WiFi** or **WPS** LED starts blinking slowly. Alternatively, log into the Zyxel Device's Web Configurator, and then go to the **Network Setting > Wireless > WPS** screen. Enable **WPS** and **Method 1 PBC**, click **Apply**, and then click the **WPS** button.
- 3 Log into the Zyxel Device's Web Configurator, and then go to the **Network Setting > Wireless > WPS** screen. Enable **WPS** and **Method 1 PBC**, click **Apply**, and then click the **WPS** button.

**Figure 49** Network Setting > Wireless > WPS

WiFi Protected Setup (WPS) allows you to quickly set up a wireless network with strong security, without having to configure security settings manually. To set up a WPS connection between two devices, both devices must support WPS. It is recommended to use the Push Button Configuration (PBC) method if your wireless client supports it.

**General**

WPS

**Add a new device with WPS Method**

Method 1 PBC	Method 2 PIN	Method 3
<input checked="" type="checkbox"/>	<input checked="" type="checkbox"/>	<input checked="" type="checkbox"/>
<b>Step1.</b> Click WPS button <b>WPS</b>	<b>Step1.</b> Enter the PIN of your new wireless client device and then click Register	<b>Enter AP's PIN Number in wireless Client</b> <b>Current state</b> Configured
<b>Step2.</b> Press the WPS button on your new wireless client device within 120 seconds	<input type="text"/> Register	1. Please release configuration if you want to configure the wireless settings Release Configuration
	<b>Step2.</b> Press the WPS button on your new wireless client device within 120 seconds	2. Enter current PIN number on your wireless client Generate New PIN

Note

(1) If WPS is Enabled, UPnP will automatically be turned on.  
(2) The Zyxel Device applies the security settings of the main SSID (SSID1) profile.  
(3) The WPS switch is grayed out when wireless LAN is disabled.

Cancel **Apply**

Figure 50 Network Setting &gt; Wireless &gt; WPS

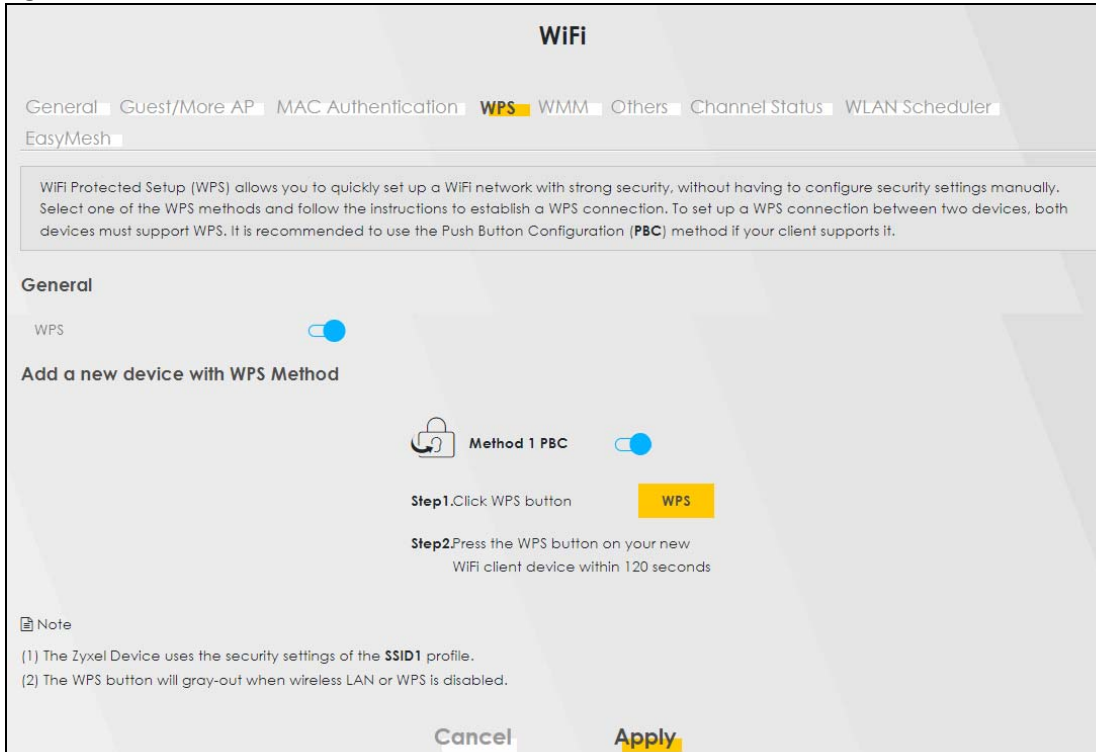

- 4 In Windows 10, click on the Network icon in the system tray to open the list of available WiFi networks.



- 5 Locate the WiFi network of the Zyxel Device. The default WiFi network name is "Zyxel\_XXXX" (2.4G) or "Zyxel\_XXXX\_5G" (5G). Then click **Connect**.

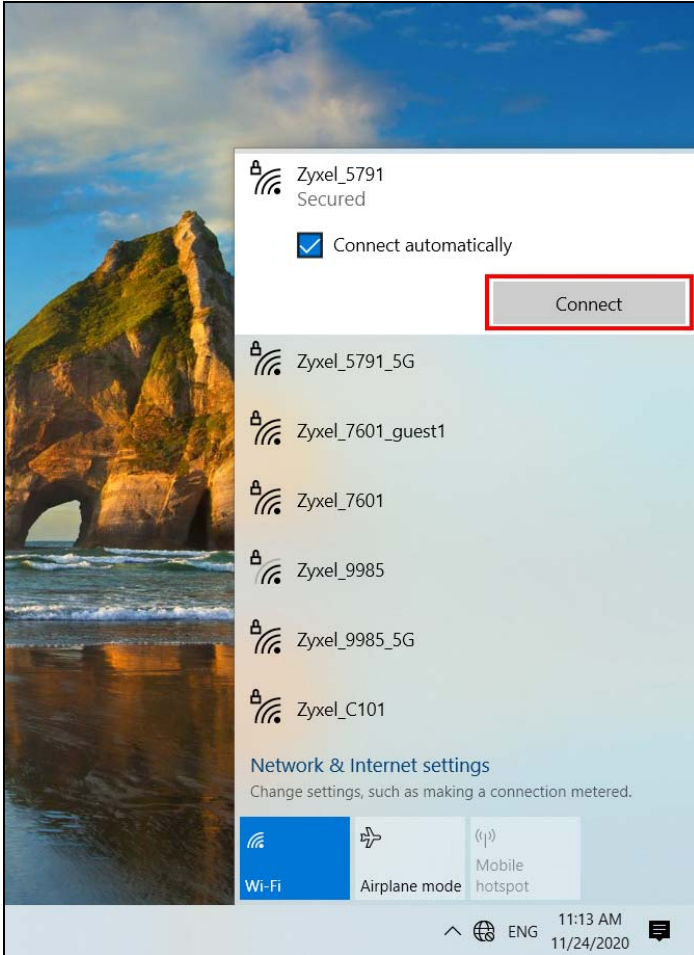

The Zyxel Device sends the WiFi network settings to Windows using WPS. Windows displays "Getting settings from the router".

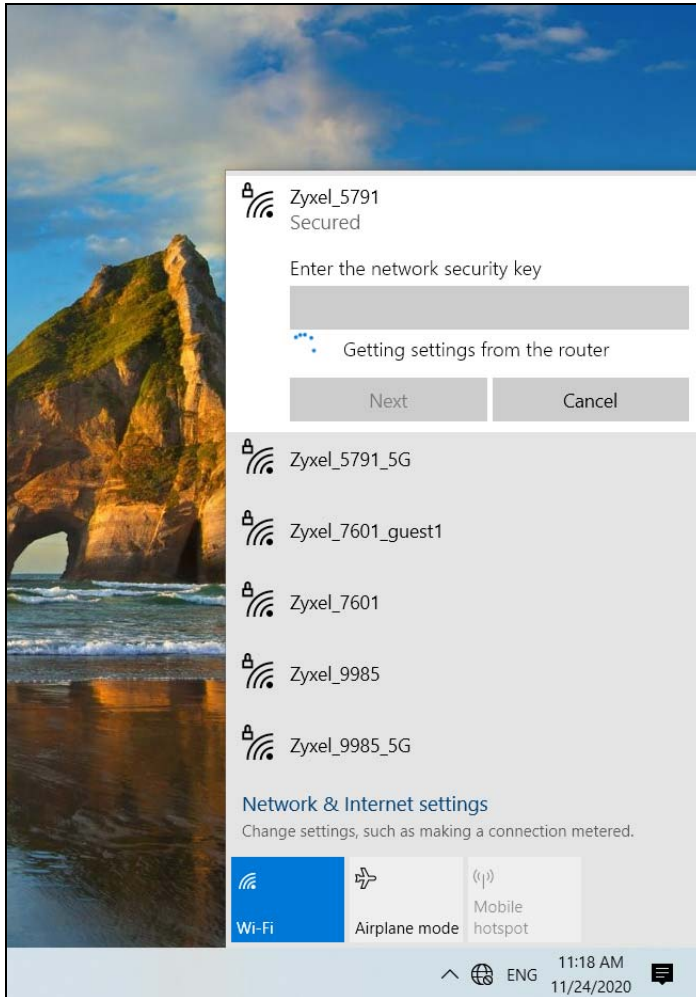

The WiFi device is then able to connect to the WiFi network securely.

### 5.3.4 Setting Up a Guest Network

The Zyxel Device authenticates the WiFi device using the PIN, and then sends the WiFi network settings to the device using WPS. This process may take up to 2 minutes. The WiFi device is then able to connect to the WiFi network securely. A company wants to create two WiFi networks for different groups of users as shown in the following figure. Each WiFi network has its own SSID and security mode. Both networks are accessible on both 2.4G and 5G WiFi bands.

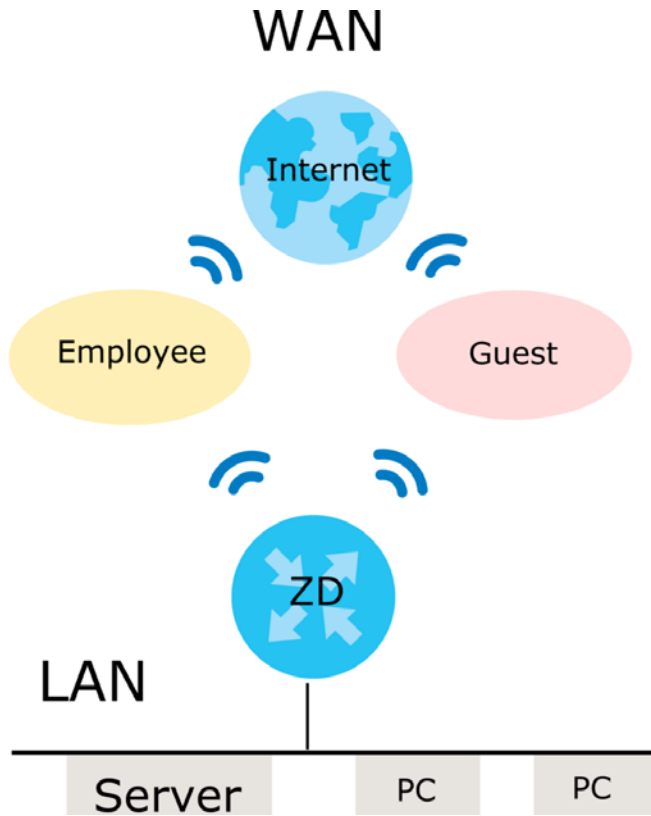

- Employees using the **General** WiFi network group will have access to the local network and the Internet.
- Visitors using the **Guest** WiFi network group with a different SSID and password will have access to the Internet only.

Use the following parameters to set up the WiFi network groups.

	GENERAL	GUEST
<b>2.4/5G SSID</b>	Employee	Guest
<b>Security Level</b>	More Secure	More Secure
<b>Security Mode</b>	WPA2-PSK	WPA2-PSK
<b>Pre-Shared Key</b>	ForCompanyOnly	guest123

Go to the **Network Setting > Wireless > General** screen. Use this screen to set up the company's general WiFi network group. Configure the screen using the provided parameters and click **Apply**. Note that if you have employees using 2.4G and 5G devices, enable **Keep the same settings for 2.4G and 5G wireless networks** to use the same SSID and password. Clear it if you want to configure different SSIDs and passwords for 2.4G and 5G bands.

**Wireless**

**General** | Guest/More AP | MAC Authentication | WPS | WMM | Others | Channel Status | MESH

Use this screen to enable the Wireless LAN, enter the SSID and select the wireless security mode. We recommend that you select More Secure to enable WPA2-PSK data encryption.

**Wireless**

Wireless  Keep the same settings for 2.4G and 5G wireless networks

**Wireless Network Setup**

Band: 2.4GHz

Wireless:

Channel: Auto Current: 4 / 20 MHz

Bandwidth: 20/40MHz

Control Sideband: Upper

**Wireless Network Settings**

Wireless Network Name: Employee

Max Clients: 32

Hide SSID ⓘ

Multicast Forwarding

Max. Upstream Bandwidth:  Kbps

Max. Downstream Bandwidth:  Kbps

**Note**

(1) If you are configuring the Zyxel Device from a computer connected by WiFi and you change the Zyxel Device's SSID, channel or security settings, you will lose your WiFi connection when you press **Apply**. You must change the WiFi settings of your computer to match the new settings on the Zyxel Device.

(2) If upstream/downstream bandwidth is empty, the Zyxel Device sets the value automatically. Setting a maximum upstream/downstream bandwidth will significantly decrease wireless performance.

BSSID: 08:26:97:03:47:D1

**Security Level**

No Security More Secure (Recommended)

Security Mode: WPA2-PSK

Generate password automatically

Enter 8-63 ASCII characters or 64 hexadecimal digits ["0-9", "A-F"].

Password: ForCompanyOnly

Strength: strong

**Cancel** **Apply**

- 6 Go to the **Network Setting > Wireless > Guest/More AP** screen. Click the **Modify** icon to configure the second WiFi network group.

**General** | **Guest/More AP** | MAC Authentication | WPS | WMM | Others | Channel Status | MESH

This screen allows you to configure a guest wireless network that allows access to the Internet only through the Zyxel Device.

#	Status	SSID	Security	Guest WLAN	Modify
1	⚠	Guest	WPA2-Personal	External Guest	

- 7 On the **Guest/More AP** screen, click the **Modify** icon to configure the other Guest WiFi network group. Configure the screen using the provided parameters and click **OK**.

✕

### More AP Edit

Wireless security can protect the data from unauthorized access or damage via wireless network. You need a wireless network name (also known as SSID) and security mode to set up the wireless security.

#### Wireless Network Setup

Wireless

#### Security Level

Wireless Network Name

Hide SSID

Guest WLAN

Access Scenario External Guest ▼

Max. Upstream Bandwidth

Max. Downstream Bandwidth

**Note**

(1) Max. Upstream Bandwidth: This field allows you to configure the maximum bandwidth of this SSID to WAN.

(2) Max. Downstream Bandwidth: This field allows you to configure the maximum bandwidth of WAN to this SSID.

(3) If Max. Upstream/Downstream Bandwidth is empty, the CPE sets the value automatically.

(4) Using Max. Upstream/Downstream Bandwidth will significantly decrease the wireless performance.

BSSID 00:00:00:00:00:00

SSID Subnet

#### Security Level

No Security
More Secure (Recommended)

Security Mode WPA2-PSK ▼

Generate password automatically

Enter 8-63 ASCII characters or 64 hexadecimal digits ("0-9", "A-F").

Password  🔍

Cancel
OK



- 8 Check the status of **Guest** in the **Guest/More AP** screen. A yellow bulb under **Status** means the SSID is active and ready for WiFi access.

#	Status	SSID	Security	Guest WLAN	Modify
1		Guest	WPA2-Personal	External Guest	

### 5.3.5 Setting Up Two Guest WiFi Networks on Different WiFi Bands

In this example, a company wants to create two Guest WiFi networks: one for the **Guest** group and the other for the **VIP** group as shown in the following figure. Each network will have its SSID and security mode to access the internet.

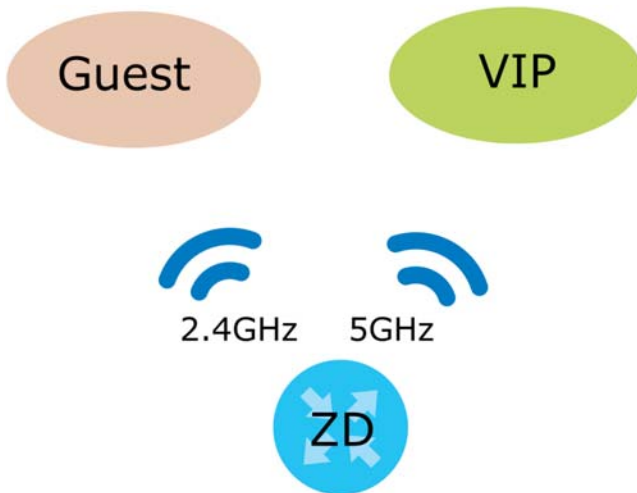

- The **Guest** group will use the 2.4G band.
- The **VIP** group will use the 5G band.

The Company will use the following parameters to set up the WiFi network groups.

Table 16 WiFi Settings Parameters Example

BAND	2.4G	5G
SSID	Guest	VIP
Security Mode	WPA3-SAE/WPA2-PSK	WPA3-SAE/WPA2-PSK
Pre-Shared Key	guest123	123456789

- 1 Go to the **Wireless > General** screen and set **Band** to **2.4GHz** to configure 2.4G Guest WiFi settings for **Guest**. Click **Apply**.

Note: You will not be able to configure the 2.4G and 5G Guest WiFi settings separately if **Keep the same settings for 2.4G and 5G wireless network** is enabled.

## Wireless

**General**Guest/More APMAC AuthenticationWPSWMMOthersChannel Status

Use this screen to enable the Wireless LAN, enter the SSID and select the wireless security mode. We recommend that you select **More Secure** to enable **WPA2-PSK** data encryption.

### Wireless

Wireless  Keep the same settings for 2.4G and 5G wireless networks

### Wireless Network Setup

Band

Wireless

Channel  Current: 3 / 20 MHz

Bandwidth

Control Sideband

### Wireless Network Settings

Wireless Network Name

Max Clients

Hide SSID i

Multicast Forwarding

Max. Upstream Bandwidth  Kbps

Max. Downstream Bandwidth  Kbps

- 2 Go to the **Wireless > Guest/More AP** screen and click the **Modify** icon. The following screen appears. Configure the **Security Mode** and **Password** using the provided parameters and click **OK**.

**More AP Edit**

Use this screen to create Guest and additional wireless networks with different security settings.

**Wireless Network Setup**

Wireless

**Wireless Network Settings**

Wireless Network Name

Hide SSID

Guest WLAN

Access Scenario

Max. Upstream Bandwidth  Kbps

Max. Downstream Bandwidth  Kbps

**Note**

If upstream/downstream bandwidth is empty, the Zyxel Device sets the value automatically. Setting a maximum upstream/downstream bandwidth will significantly decrease wireless performance.

BSSID

SSID Subnet

**Security Level**

No Security More Secure (Recommended)

Security Mode

Generate password automatically

Enter 8-63 ASCII characters or 64 hexadecimal digits ["0-9", "A-F"].

Password

Strength

Cancel

The 2.4 GHz **Guest** WiFi network is now configured.

**Wireless**

General **Guest/More AP** MAC Authentication WPS WMM Others Channel Status MESH

This screen allows you to configure a guest wireless network that allows access to the Internet only through the Zyxel Device.

#	Status	SSID	Security	Guest WLAN	Modify
1		Guest	WPA2-Personal	External Guest	

- Go to the **Wireless > General** screen and set **Band** to **5GHz** to configure the 5G Guest WiFi settings for **VIP**. Click **OK**.

## Wireless

**General** Guest/More AP MAC Authentication WPS WMM Others Channel Status

Use this screen to enable the Wireless LAN, enter the SSID and select the wireless security mode. We recommend that you select **More Secure** to enable **WPA2-PSK** data encryption.

### Wireless

Keep the same settings for 2.4G and 5G wireless networks

### Wireless Network Setup

Band

Wireless

Channel  Current: 60 / 160 MHz

Bandwidth

Control Sideband

### Wireless Network Settings

Wireless Network Name

Max Clients

Hide SSID 

Multicast Forwarding

Max. Upstream Bandwidth  Kbps

Max. Downstream Bandwidth  Kbps

- 4 Go to the **Wireless > Guest/More AP** screen and click the **Modify** icon. The following screen appears. Configure the **Security Mode** and **Password** using the provided parameters and click **OK**.

**More AP Edit**

Use this screen to create Guest and additional wireless networks with different security settings.

**Wireless Network Setup**

Wireless

**Wireless Network Settings**

Wireless Network Name

Hide SSID

Guest WLAN

Access Scenario

Max. Upstream Bandwidth  Kbps

Max. Downstream Bandwidth  Kbps

**Note**  
If upstream/downstream bandwidth is empty, the Zyxel Device sets the value automatically. Setting a maximum upstream/downstream bandwidth will significantly decrease wireless performance.

BSSID

SSID Subnet

**Security Level**

No Security More Secure (Recommended)

---

Security Mode

Generate password automatically  
Enter 8-63 ASCII characters or 64 hexadecimal digits ["0-9", "A-F"].

Password

Strength  medium

Cancel OK

The 5G **VIP** WiFi network is now configured.

**Wireless**

General **Guest/More AP** MAC Authentication WPS WMM Others Channel Status MESH

This screen allows you to configure a guest wireless network that allows access to the Internet only through the Zyxel Device.

#	Status	SSID	Security	Guest WLAN	Modify
1		VIP	WPA2-Personal	External Guest	

## 5.4 Cellular Network Setup

This section shows you how to set up a cellular network.

### 5.4.1 Setting up a Cellular Network Connection

This section gives you an example on how to connect to the Internet using over a cellular connection.

- 1 Insert a SIM Card into your Zyxel Device SIM slot. Make sure this SIM card has an active data plan with your Internet Service Provider (ISP).
- 2 Connect your Zyxel Device to your computer, and log into the Web Configurator.
- 3 If your SIM has a PIN Code, enter this code in the **Network Setting > Broadband > Cellular SIM** screen.

Use the Home screen to check the Internet Status (IPv4) or Internet Status (IPv6). If it shows Connected this means your Internet connection is up.

## 5.5 USB Applications

This section shows you how to set up a cellular backup network, access shared folders and play files through Window Media using a USB device.

See [Table 1 on page 17](#) for more information.

### 5.5.1 File Sharing

This section shows you how to create a shared folder on your Zyxel Device through a USB device and allow others to access the shared folder with File Sharing services.

#### 5.5.1.1 Setting up File Sharing on Your Zyxel Device

- 1 Before enabling file sharing in the Zyxel Device, please set up your shared folders beforehand in your USB device.
- 2 Connect your USB device to the USB port of the Zyxel Device.
- 3 Go to the **Network Setting > USB Service > File Sharing** screen. Enable **File Sharing Services** and click **Apply** to activate the file sharing function. The Zyxel Device automatically adds your USB device to the **Information** table.

## USB Service

**FileSharing** MediaServer

The device can share Files from your USB flash drive or disk when you attach it to the USB port. You may Start from deciding which folders in the USB disks to share and which users can access the shared folders.

### Information

Volume	Capacity	Used Space
usb1_sda1	0 MB	0 MB

### Server Configuration

File Sharing Services

### Share Directory List

+ Add New Share

Active	Status	Share Name	Share Path	Share Description	Modify
--------	--------	------------	------------	-------------------	--------

### Account Management

+ Add New User

Status	User Name
	admin

[Cancel](#) [Apply](#)

- 4 Click **Add New Share** to add a new share.

### USB Service

**FileSharing** MediaServer

The device can share Files from your USB flash drive or disk when you attach it to the USB port. You may Start from deciding which folders in the USB disks to share and which users can access the shared folders.

**Information**

Volume	Capacity	Used Space
usb1_sda1	0 MB	0 MB

**Server Configuration**

File Sharing Services

**Share Directory List** + Add New Share

Active	Status	Share Name	Share Path	Share Description	Modify

**Account Management** + Add New User

Status	User Name
	admin

Cancel Apply

- 5 The **Add New Share** screen appears.
- Select your USB device from the **Volume** drop-down list box.
  - Enter a **Description** name for the added share to identify the device.
  - Click **Browse** and the **Browse Directory** screen appears.

### Add New Share

Volume: usb1\_sda1

Share Path: BobShare Browse

Description: Bob

Access Level: Public

Cancel OK

- On the **Browse Directory** screen, select the folder that you want to add as a share. In this example, select **BobShare** and then click **OK**.



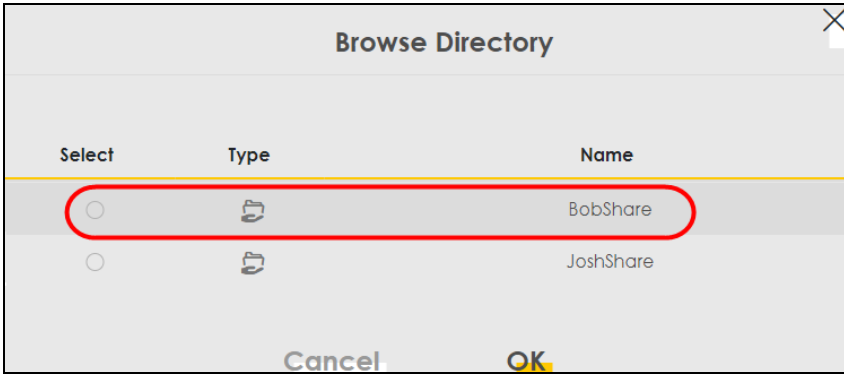

- In **Access Level**, select **Public** to let the share to be accessed by all users connected to the Zyxel Device. Otherwise, select **Security** to let the share to be accessed by specific users to access only. Click **OK** to save the settings.

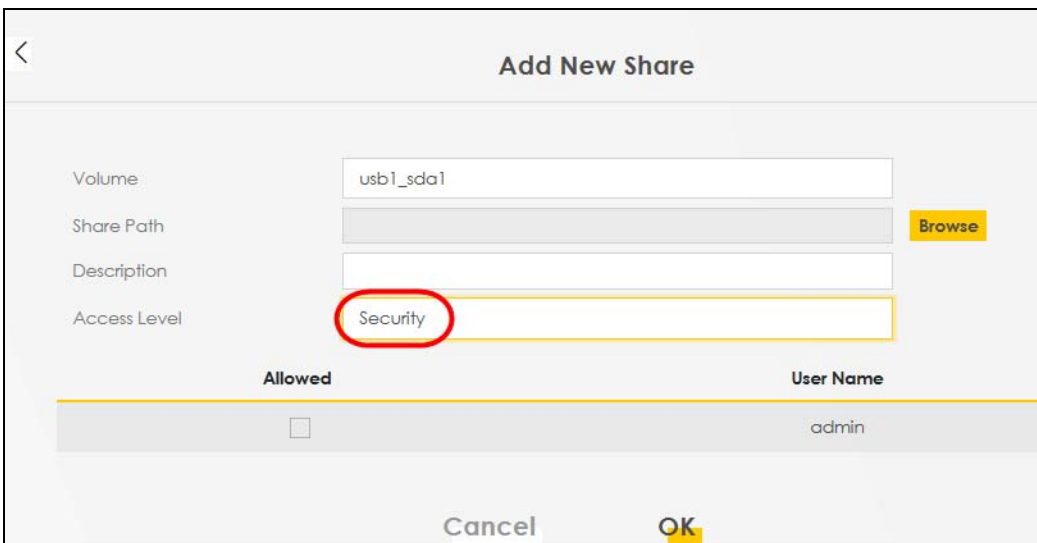

- 6 To set **Access level** to **Security**, you need to create one or more users accounts. Under **Account Management**, click **Add New User** to open the **User Account** screen.

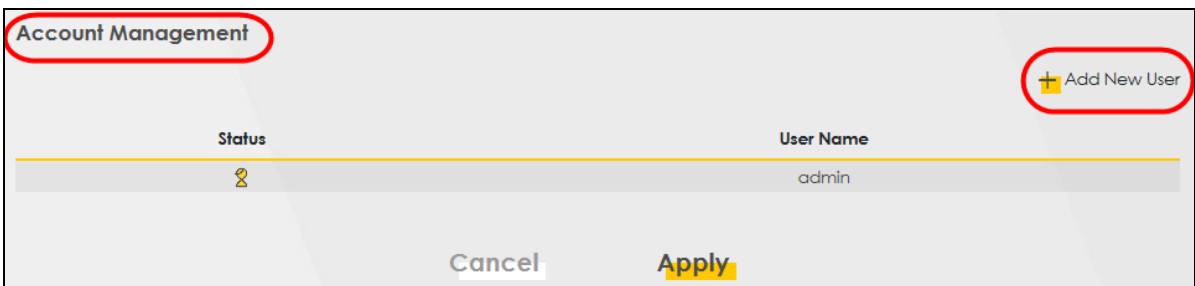

- 7 After you create a new user account, the screen looks like the following.

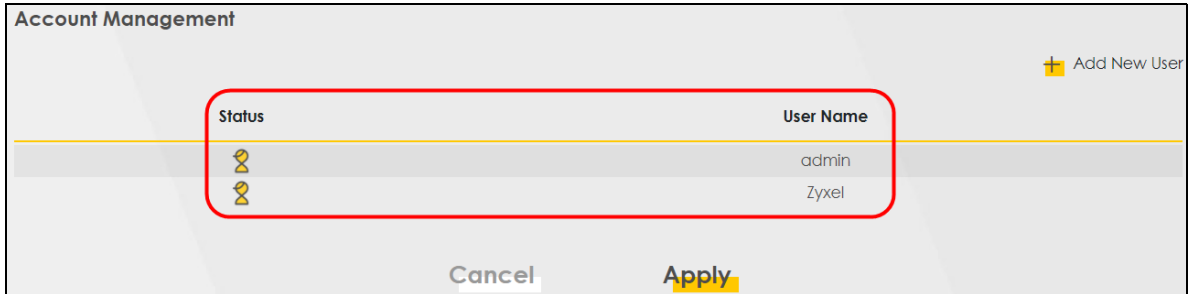

- 8 File sharing is now configured. You can see the USB storage device listed in the table below.

Active	Status	Share Name	Share Path	Share Description	Modify
<input checked="" type="checkbox"/>	⚡	BobShare	/mnt/usb1_sda1/BobShare	Bob	
<input checked="" type="checkbox"/>	⚡	JoshShare	/mnt/usb1_sda1/JoshShare	Josh	

### 5.5.1.2 Accessing Your Shared Files From a Computer

You can use Windows Explorer to access the USB storage devices connected to the Zyxel Device.

Note: This example shows you how to use Microsoft Windows 10 to browse shared files in a share called (usb1\_sda)Zoey's file. Refer to your operating system's documentation for how to browse your file structure.

- 1 Open Windows Explorer.
- 2 In the Windows Explorer's address bar, enter a double backslash "\\\" followed by the IP address of the Zyxel Device (the default IP address of the Zyxel Device is 192.168.1.1

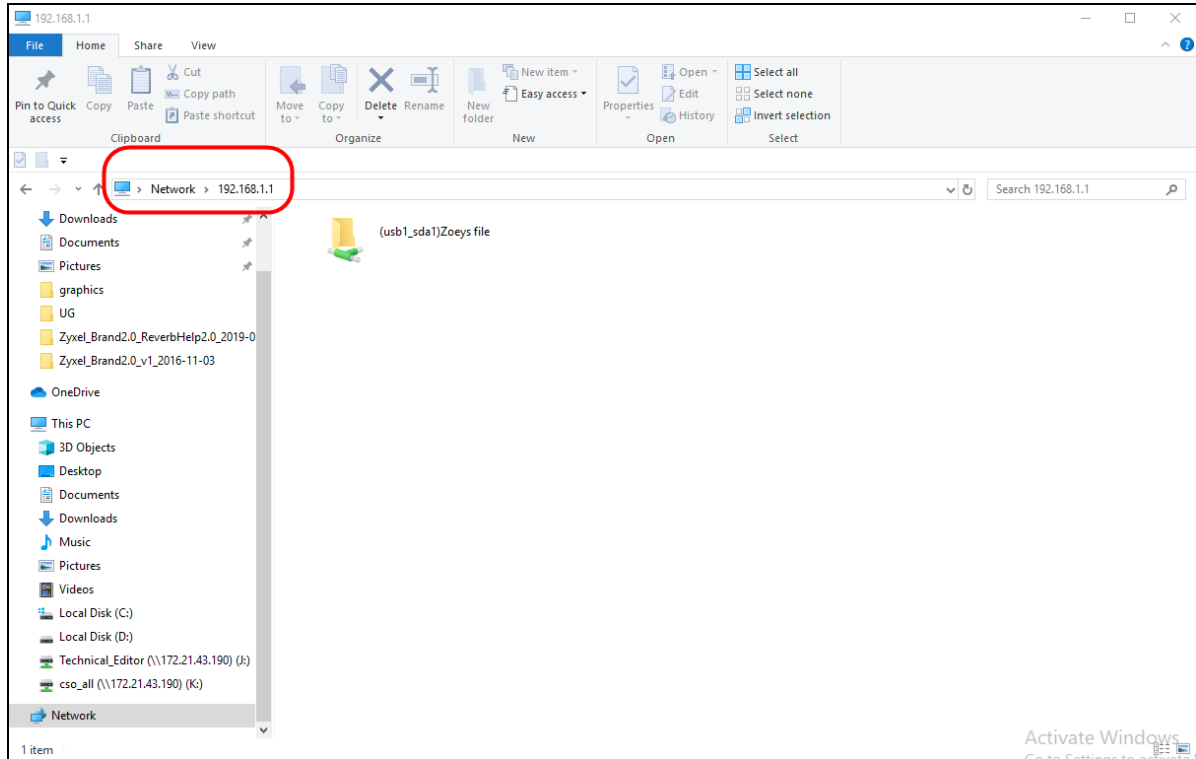

- 3 Double-click on **(usb1\_sda)Zoey's file**, and then enter the share's username and password if prompted.
- 4 After you access **(usb1\_sda)Zoey's file** through your Zyxel Device, you do not have to log in again unless you restart your computer.

## 5.6 Network Security

This section shows you how to configure a Firewall rule, Parental Control rule, and MAC Filter rule.

### 5.6.1 Configuring a Firewall Rule

You can enable the firewall to protect your LAN computers from malicious attacks from the Internet.

- 1 Go to the **Security > Firewall > General** screen.
- 2 Select **IPv4 Firewall/IPv6 Firewall** to enable the firewall, and then click **Apply**.

**General** Protocol Access Control DoS

The firewall blocks unauthorized access to your network. Drag and drop the indicator to set a security level. Also note that a higher firewall level means more restrictions to the internet activities you want to perform.

IPv4 Firewall

IPv6 Firewall

Low Medium (Recommended) High

LAN to WAN

WAN to LAN

Note

(1) LAN to WAN: Allow access to all internet services

(2) WAN to LAN: Allow access from other computers on the internet

(3) When the security level is set to "High", access to the following services is allowed:  
Telnet,FTP,HTTP,HTTPS,DNS,IMAP,POP3,SMTP and IPv6 Ping

Cancel **Apply**

- 3 Open the **Access Control** screen, click **Add New ACL Rule** to create a rule.

**Firewall**

General Protocol **Access Control** DoS

An Access Control List (ACL) rule is a manually-defined rule that can accept, reject, or drop incoming or outgoing packets from your network based on the type of service. For example, you could block users using Instant Messaging in your network. This screen displays a list of the configured incoming or outgoing filtering rules. Note the order in which the rules are listed.

The ordering of your rules is very important as rules are applied in turn.

Rules Storage Space Usage 0%

**+ Add New ACL Rule**

#	Name	Src IP	Dest IP	Service	Action	Modify
---	------	--------	---------	---------	--------	--------

- 4 Use the following fields to configure and apply a new ACL (Access Control List) rule.

The screenshot shows the 'Add New ACL Rule' configuration page. The form is filled with the following values:

- Filter Name: [Empty]
- Order: 1
- Select Source IP Address: Specific IP Address
- Source IP Address: [Empty] [ /prefix length]
- Select Destination Device: Specific IP Address
- Destination IP Address: [Empty] [ /prefix length]
- IP Type: IPv4
- Select Service: Specific Service
- Protocol: ALL
- Custom Source Port: Range [ 1 ] - [ 1 ]
- Custom Destination Port: Range [ 1 ] - [ 1 ]
- Policy: ACCEPT
- Direction: WAN to LAN
- Enable Rate Limit: [ Disabled ]
- Scheduler Rules: [ Add New Rule ]

- **Filter Name:** Enter a name to identify the firewall rule.:
- **Source IP Address:** Enter the IP address of the computer that initializes traffic for the application or service.
- **Destination IP Address:** Enter the IP address of the computer to which traffic for the application or service is entering.
- **Protocol:** Select the protocol (**ALL**, **TCP/UDP**, **TCP**, **UDP**, **ICMP** or **ICMPv6**) used to transport the packets.
- **Policy:** Select whether to (**ACCEPT**, **DROP**, or **REJECT**) the packets.
- **Direction:** Select the direction (**WAN to LAN**, **LAN to WAN**, **WAN to ROUTER**, or **LAN to ROUTER**) of the traffic to which this rule applies.

5 Select **Enable Rate Limit** to activate the rules you created. Click **OK**.

## 5.6.2 Parental Control

This section shows you how to configure rules for accessing the Internet using parental control.

Note: The style and features of your parental control vary depending on the Zyxel Device you are using.

### 5.6.2.1 Configuring Parental Control Schedule and Filter

Parental Control Profile (PCP) allows you to set up a rule for:

- Internet usage scheduling.
- Websites and URL keyword blocking.

Use this feature to:

- Limit the days and times a user can access the Internet.
- Limit the websites a user can access on the Internet.

This example shows you how to block a user from accessing the Internet during time for studying. It also shows you how to stop a user from accessing specific websites.

Use the parameters below to configure a schedule rule and a URL keyword blocking rule.

PROFILE NAME	INTERNET ACCESS SCHEDULE	NETWORK SERVICE	SITE/URL KEYWORD
Study	<b>Day:</b> Monday to Friday  <b>Time:</b> 8:00 to 11:00 13:00 to 17:00	<b>Network Service Setting:</b> Block  <b>Service Name:</b> HTTP  <b>Protocol:</b> TCP  <b>Port:</b> 80	<b>Block or Allow the Web Site:</b> Block the web URLs  <b>Website:</b> gambling

#### Parental Control Screen

Open the **Parental Control** screen. Select **Enable** under **General** to enable parental control. Then click **Add New PCP** to add a rule.

## Parental Control

Parental control allows you to limit the time a user can access the Internet and prevent users from viewing inappropriate content or participating in specified online activities.

Use this screen to enable parental control and view parental control rules and schedules. You can limit the time a user can access the Internet and prevent users from viewing inappropriate content or participating in specified online activities. These rules are defined in a Parental Control Profile (PCP).

**General**

Parental Control  Enable  Disable (Settings are invalid when disable)

Parental Control Profile(PCP) + Add New PCP

#	Status	PCP Name	Home Network User MAC	Internet Access Schedule	Network Service	Website Blocked	Modify
<span>Cancel</span> <span style="margin-left: 100px;">Apply</span>							

### Add New PCP Screen

- Go to Parental Control > Add New PCP. Under **General**:
  - Select **Enable** to enable the rule you are configuring.
  - Enter the **Parental Control Profile Name** given in the above parameter.
  - Select an user this rule applies to in **Home Network User**, then click **Add**. You will see the MAC address of the user you just select in **Rule List**.

**General**

Active  Enable  Disable (Settings are invalid when disable)

Parental Control Profile Name

Home Network User  Add

---

**Rule List**

User MAC Address	Delete
DC-4A-3E-40-EC-67	Delete

- Under **Internet Access Schedule**:
  - Click **Add New Time** to add a second schedule.
  - Use the parameter given above to configure the time settings of your schedule.

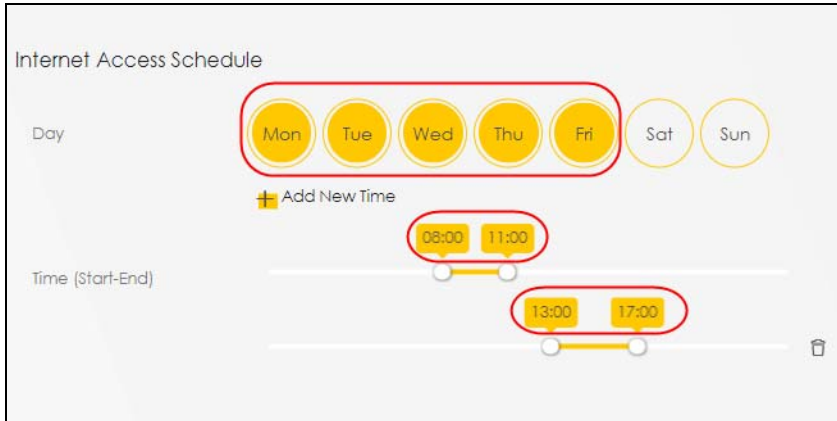

**3 Under Network Service:**

- In **Network Service Setting**, select **Block**.
- Click **Add New Service**, then use the parameter given above to configure settings for the Internet service you are blocking.

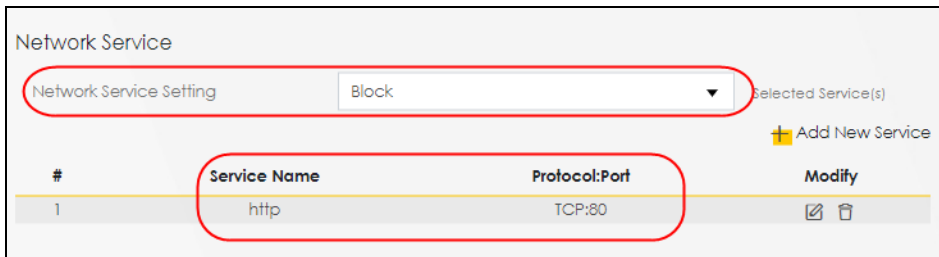

**4 Under Site / URL Keyword:**

- Select **Block the web URLs** in **Block or Allow the Web Site**.
- Click **Add**, then use the parameter given above to configure settings for the URL keyword you are blocking.
- Select **Redirect blocked site to Zyxel Family Safety page** to redirect the web browser to the Zyxel Family Safety page if he or she tries to access a website with the blocked URL keyword.

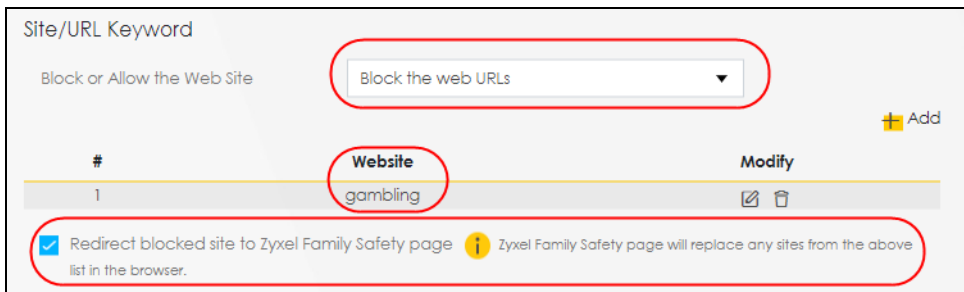

**5 Click OK to save your settings.**

### 5.6.3 Configuring a MAC Address Filter for Wired LAN Connections

You can use a MAC address filter to exclusively allow or permanently block someone from the wired LAN network.



This example shows that computer B is not allowed access to the wired LAN network.

**Figure 51** Configure a MAC Address Filter Example

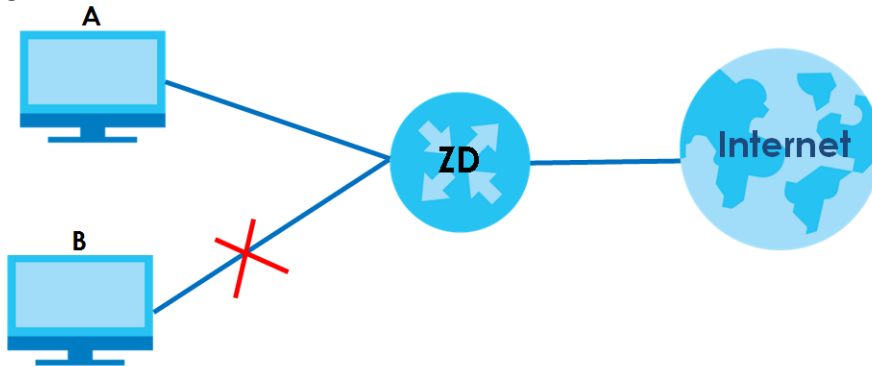

- 1 Go to the **Security > MAC Filter > MAC Filter** screen. Under **MAC Address Filter**, select **Enable**.

### MAC Filter

You can configure the Zyxel Device to permit access to clients based on their MAC addresses in the **MAC Filter** screen. This applies to wired and wireless connections. Every Ethernet device has a unique MAC (Media Access Control) address. The MAC address is assigned at the factory and consists of six pairs of hexadecimal characters, for example, 00:A0:C5:00:00:02. You need to know the MAC addresses of the LAN client to configure this screen.

MAC Address Filter  Enable  Disable (Settings are invalid when disable)

MAC Restrict Mode  Allow  Deny

[+ Add New Rule](#)

Set	Active	Host Name	MAC Address	Delete
<p><small>Note</small></p> <p>Enable <b>MAC Address Filter</b> and add the host name and MAC address of a LAN client to the table if you wish to allow or deny them access to your network.</p>				

Cancel
Apply

- 2 Click **Add New Rule** to add a new entry. Select **Active**, and then enter the **Host Name** and **MAC Address** of computer B. Click **Apply**.

MAC Address Filter  Enable  Disable (Settings are invalid when disable)

MAC Restrict Mode  Allow  Deny

[+ Add New Rule](#)

Set	Active	Host Name	MAC Address	Delete
1	<input checked="" type="checkbox"/>	B	00 - 24 - 21 - AB - 1F - 00	

[Cancel](#) [Apply](#)

## 5.7 Internet Calls

This section shows you how to make Internet calls.

### 5.7.1 Configuring VoIP

To make voice calls over the Internet, you must set up a Session Initiation Protocol (SIP) provider and SIP account on the Zyxel Device. You should have an account with a SIP service provider already set up.

### 5.7.2 Adding a SIP Service Provider

Follow the steps below to add a SIP service provider.

- 1 Make sure your Zyxel Device is connected to the Internet.
- 2 Open the Web Configurator.
- 3 Go to the **Voice > SIP > SIP Service Provider** screen. Click the **Add New Provider** button to add the SIP Service Provider.

SIP Account **SIP Service Provider**

Use this screen to view the SIP service provider information on the Zyxel Device. A SIP provider offers Internet call services using VoIP technology. You may need to consult your SIP service provider for the following settings.

[+ Add New Provider](#)

#	SIP Service Provider Name	SIP Proxy Server Address	REGISTER Server Address	SIP Service Domain	Modify
1	Verizon	sip.infostrada.it	sip.infostrada.it	sip.infostrada.it	

- 4 On the **Add New Provider** screen, select **Enable SIP Service Provider**.
- 5 Enter the **SIP Service Provider Name** of up to 64 printable characters except ["], [ ` ], [ ' ], [ < ], [ > ], [ ^ ], [ \$ ], [ | ], [ & ], or [ ; ].

- 6 Enter **SIP Proxy Server Address**, **SIP REGISTRAR Server Address**, and **SIP Service Domain** provided by your SIP service provider. Click **OK** to save your settings.

**Add New Provider**

**SIP Service Provider Selection**

Service Provider Selection    ADD\_NEW

**General**

SIP Service Provider     Enable SIP Service Provider

SIP Service Provider Name    Verizon

SIP Local Port    5060    (1025~65535)

SIP Proxy Server Address    sip.infostrada.it

SIP Proxy Server Port    5060    (1025~65535)

SIP REGISTRAR Server Address    sip.infostrada.it

SIP REGISTRAR Server Port    5060    (1025~65535)

SIP Service Domain    sip.infostrada.it

Cancel    **OK**

### 5.7.3 Adding a SIP Account

The SIP account must be associated with the SIP service provider configured above. You may configure several SIP accounts for the same service provider. Follow the steps below to set up your SIP account:

- 1 Make sure your Zyxel Device is connected to the Internet.
- 2 Open the Web Configurator.
- 3 Go to the **Voice > SIP > SIP Account** screen.
- 4 Click the **Add New Account** button on the **SIP Account** screen to add a SIP account and map it to a phone port.

**SIP Account** SIP Service Provider

You can make calls over the Internet using VoIP technology. For this, you first need to set up a SIP account with a SIP service provider.

The Zyxel Device uses a SIP account to make outgoing VoIP calls and check if an incoming call's destination number matches your SIP account's VoIP number. In order to make or receive a VoIP call, you need to enable and configure a SIP account and map it to a phone port. The SIP account contains information that allows your Zyxel Device to connect to your VoIP service provider.

+ Add New Account

#	Enable	SIP Account	Service Provider	Account Number	Modify
1	Enabled	SIP1	Verizon	Account1	
2	Enabled	SIP2	Verizon	Account2	
3	Disabled	SIP3	Verizon	Account3	

- Under **General**, select **Enable SIP Account**, and then enter the **SIP Account Number**.
- Under **Authentication**, enter **Username** and **Password**. Leave the other settings as default. Click **OK** to save your settings.

**SIP Account Entry Edit**

**SIP Account Selection**

SIP Account Selection      SIP1

**SIP Service Provider Association**

SIP Account Associated with      Verizon

**General**

Enable SIP Account

SIP Account Number      Account1

**Authentication**

Username      User1

Password      \*\*\*\*\*

**URL Type**

URL Type      SIP

## 5.7.4 Configuring a Phone

You must now configure the phone port to use the SIP account you just configured.

- 1 Go to the **Voice > Phone > Phone Device** screen.
- 2 Click the **Modify** icon of **PHONE1** to configure PHONE1 on your Zyxel Device. The following screen appears.

#	Phone ID	Internal Number	Incoming SIP Number	Outgoing SIP Number	Modify
1	PHONE1	**11	Account1	Account1	
2	PHONE2	**12	Account2	Account2	

- 3 Under **SIP1 SIP Account to Make Outgoing Call**, select **SIP1** to have the phone connected to the first phone port use the registered SIP1 account to make outgoing calls.
- 4 Under **SIP Account(s) to Receive Incoming Call**, select **SIP1** to have the phone connected to the first phone port receive phone calls for the SIP1 account. Click **OK** to save your changes.

**Phone Device Edit**

**SIP Account to Make Outgoing Call**

SIP Account:  SIP1  SIP2

SIP Number: ChangeMe ChangeMe

**SIP Account(s) to Receive Incoming Call**

SIP Account:  SIP1  SIP2

directoryNumber: ChangeMe ChangeMe

**Immediate Dial Enable**

Immediate Dial Enable

Cancel OK

## 5.7.5 Making a VoIP Call

Follow these steps to make a phone call using Voice over IP (VoIP).

- 1 Make sure you connect a telephone to phone port 1 on the Zyxel Device.
- 2 Make sure the Zyxel Device is turned on and connected to the Internet.
- 3 Pick up the phone receiver.
- 4 Dial the VoIP phone number you want to call.

## 5.7.6 Making a VoLTE Phone Call

Follow these steps to make a phone calling using Voice over LTE (VoLTE).

- 1 Make sure that your SIM card supports VoLTE or Vo3G.
- 2 Log into the Web Configurator.
- 3 Go to the **Configuration > Voice > Voice Mode** screen.
- 4 On the **Voice Mode** screen, select **VoLTE service**, and then click **Apply**. The Zyxel Device restarts.

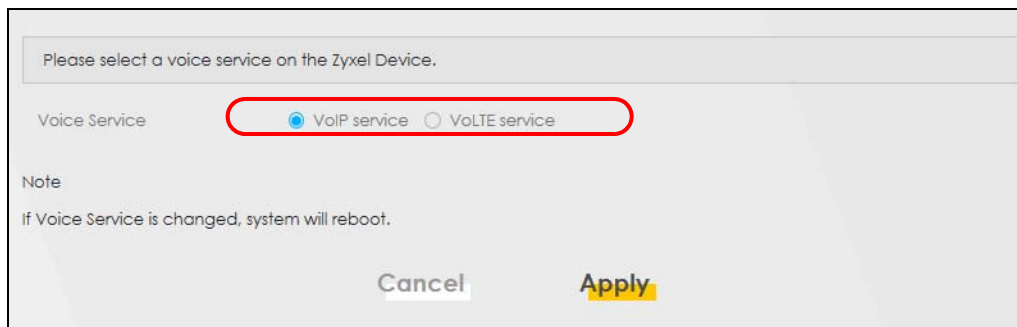

- 5 Connect an analog telephone to a **PHONE** port on the Zyxel Device.
- 6 Pick up the phone receiver.
- 7 Dial the phone number you want to call.

## 5.8 Device Maintenance

This section shows you how to upgrade the Zyxel Device firmware, back up the configuration and restore the Zyxel Device to its previous or default settings.

### 5.8.1 Upgrading the Firmware

Upload the router firmware to the Zyxel Device for feature enhancements.

- 1 Download the correct firmware file from the download library at the Zyxel website. The model code for the Zyxel Device in this example is v5.13(ABLZ.1) Note the model code for your Zyxel Device. Unzip the file.
- 2 Go to the **Maintenance > Firmware Upgrade** screen.
- 3 Click **Browse/Choose File** and select the file with a ".bin" extension to upload. Click **Upload**.

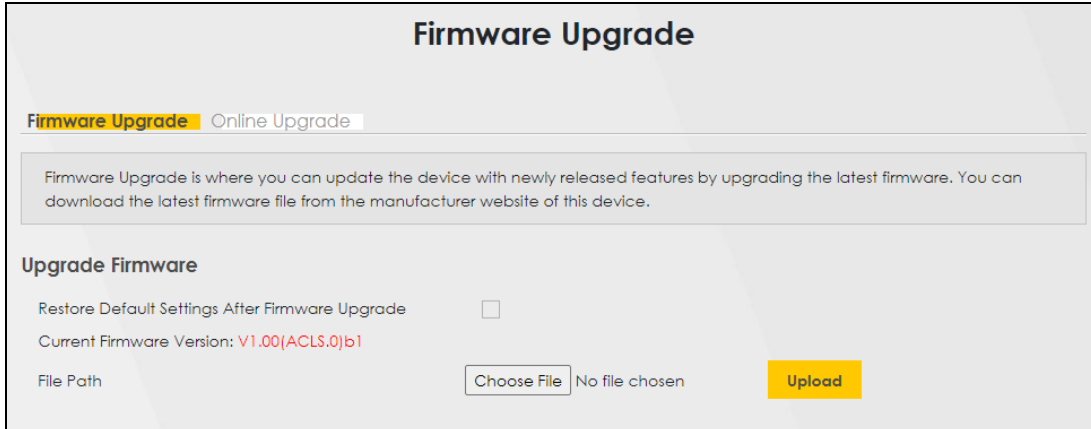

- 4 This process may take up to 2 minutes to finish. After 2 minutes, log in again and check your new firmware version in the **Connection Status** screen.

## 5.8.2 Backing up the Device Configuration

Back up a configuration file allows you to return to your previous settings.

- 1 Go to the **Maintenance > Backup/Restore** screen.
- 2 Under **Backup Configuration**, click **Backup**. A configuration file is saved to your computer. In this case, the **Backup/Restore** file is saved.

Figure 52 Maintenance &gt; Backup/Restore

## Backup/Restore

Back up and restore your Zyxel Device configurations. You can also reset your Zyxel Device settings back to the factory default.

**Backup Configuration** allows you to back up (save) the Zyxel Device's current configuration to a file on your computer. Once the Zyxel Device is configured and functioning properly, it is highly recommended that you back up your configuration file before making configuration changes. The backup configuration file will be useful in case you need to return to your previous settings.

**Restore Configuration** allows you to upload a new or previously saved configuration file from your computer to your Zyxel Device.

### Backup Configuration

Click Backup to save the current configuration of your system to your computer.

**Backup**

### Restore Configuration

To restore a previously saved configuration file to your system, browse to the location of the configuration file and click Upload.

File Path  No file chosen **Upload**

### Back to Factory Default Settings

Click Reset to clear all user-entered configuration information and return to factory default settings. After resetting, the

- Password is printed on a label on the bottom of the device, written after the text "Password".
- LAN IP address will be 192.168.1.1
- DHCP will be reset to default setting

**Reset**



Figure 53 Maintenance &gt; Backup/Restore

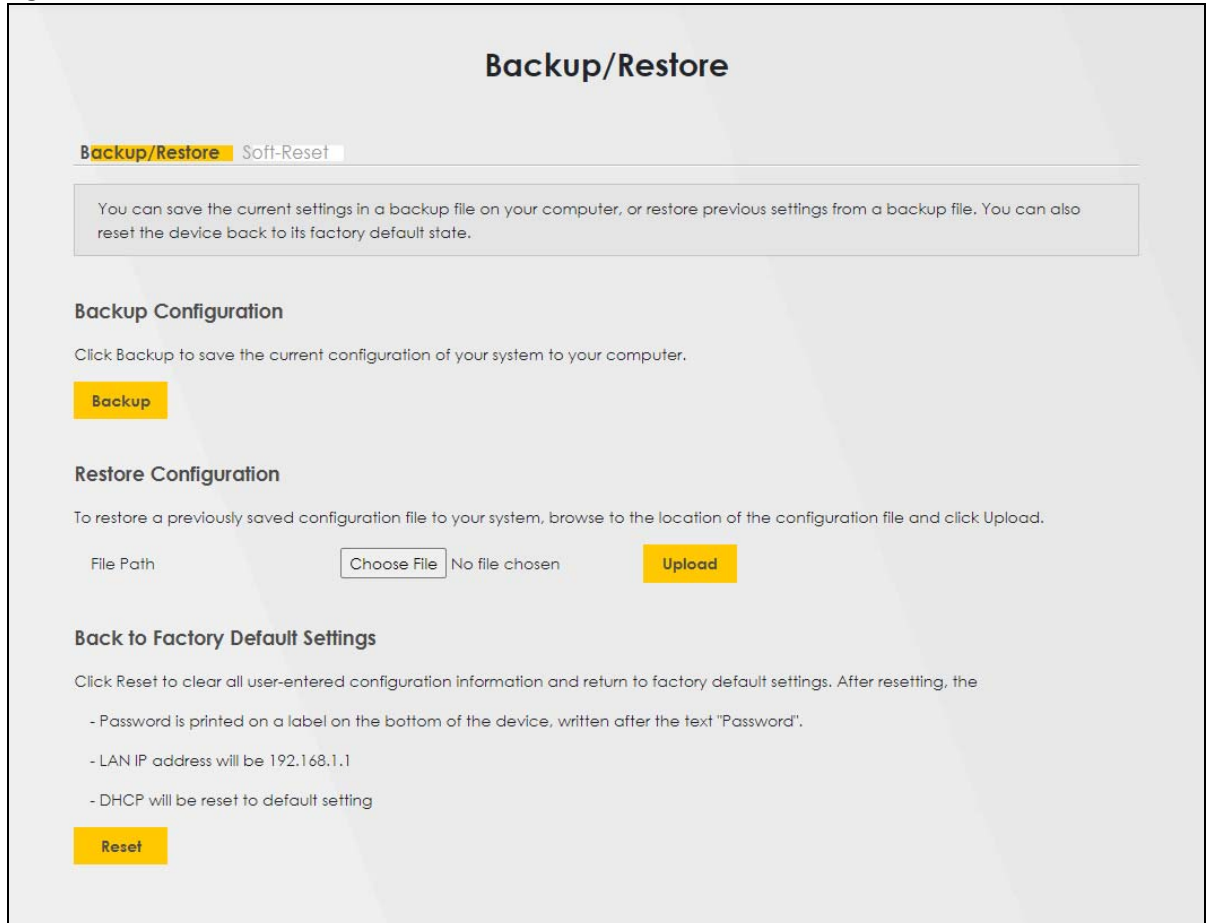

### 5.8.3 Restoring the Device Configuration

This section shows you how to restore a previously-saved configuration file from your computer to your Zyxel Device.

- 1 Go to the **Maintenance > Backup/Restore** screen.
- 2 Under **Restore Configuration**, click **Browse/Choose File**, and then select the configuration file that you want to upload. Click **Upload**.

## Backup/Restore

Information related to factory default settings and backup configuration are shown in this screen. You can also use this to restore previous device configurations.

Backup Configuration allows you to back up (save) the Zyxel Device's current configuration to a file on your computer. Once your Zyxel Device is configured and functioning properly, it is highly recommended that you back up your configuration file before making configuration changes.

Restore Configuration allows you to upload a new or previously saved configuration file from your computer to your Zyxel Device.

### Backup Configuration

Click Backup to save the current configuration of your system to your computer.

**Backup**

### Restore Configuration

To restore a previously saved configuration file to your system, browse to the location of the configuration file and click Upload.

File Path

C:\Users\NT03139\Do

Browse...

**Upload**

### Back to Factory Default Settings

Click Reset to clear all user-entered configuration information and return to factory default settings. After resetting, the

- Password is printed on a label on the bottom of the device, written after the text "Password".
- LAN IP address will be 192.168.1.1
- DHCP will be reset to default setting

**Reset**

## Backup/Restore

**Backup/Restore** | Soft-Reset

You can save the current settings in a backup file on your computer, or restore previous settings from a backup file. You can also reset the device back to its factory default state.

### Backup Configuration

Click Backup to save the current configuration of your system to your computer.

**Backup**

### Restore Configuration

To restore a previously saved configuration file to your system, browse to the location of the configuration file and click Upload.

File Path  No file chosen **Upload**

### Back to Factory Default Settings

Click Reset to clear all user-entered configuration information and return to factory default settings. After resetting, the

- Password is printed on a label on the bottom of the device, written after the text "Password".
- LAN IP address will be 192.168.1.1
- DHCP will be reset to default setting

**Reset**

- 3 The Zyxel Device automatically restarts after the configuration file is successfully uploaded. Wait for one minute before logging into the Zyxel Device again. Go to the **Connection Status** page to check the firmware version after the reboot.

## 5.8.4 Making a VoLTE Phone Call

Follow these steps to make a phone calling using Voice over LTE (VoLTE).

- 1 Make sure that your SIM card supports VoLTE or Vo3G.
- 2 Log into the Web Configurator.
- 3 Go to the **Configuration > Voice > Voice Mode** screen.
- 4 On the **Voice Mode** screen, select **VoLTE service**, and then click **Apply**. The Zyxel Device restarts.

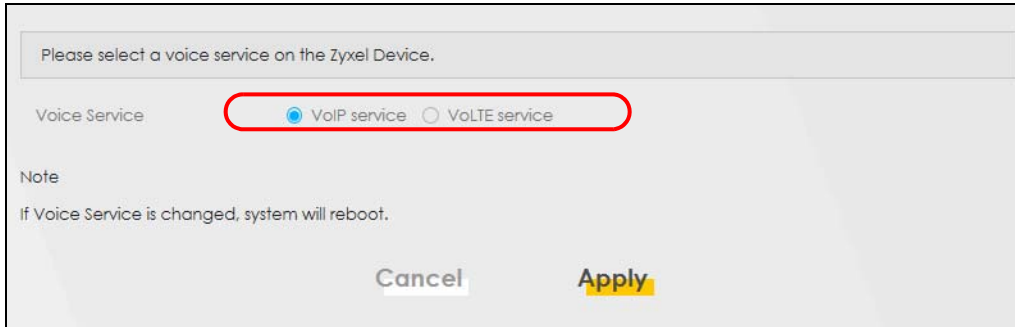

- 5 Connect an analog telephone to a **PHONE** port on the Zyxel Device.
- 6 Pick up the phone receiver.
- 7 Dial the phone number you want to call.

## 5.9 Remote Access from WAN

This section shows you how to configure WAN access for a specific trusted computer through HTTPS, FTP, SSH to the Zyxel Device. Remote management determines which interface and web services are allowed to access the Zyxel Device.

### 5.9.1 Configure Access to Your Zyxel Device

Perform the following to find the options to configure remote access to your Zyxel Device:

- 1 Go to the **Maintenance > Remote Management > MGMT Services** screen. Select how you want to access the Zyxel Device remotely.

## Remote Management

**MGMT Services** Trust Domain

Use this screen to configure the interfaces through which services can access the Zyxel Device. You can also specify service port numbers computers must use to connect to the Zyxel Device.

**Service Control**

WAN Interface used for services  Any\_WAN  Multi\_WAN

ETHWAN

Service	LAN	WLAN	WAN	Trust Domain	Port
HTTPS	<input type="checkbox"/> Enable	<input type="checkbox"/> Enable	<input type="checkbox"/> Enable	<input type="checkbox"/> Enable	443
FTP	<input type="checkbox"/> Enable	<input type="checkbox"/> Enable	<input type="checkbox"/> Enable	<input type="checkbox"/> Enable	21
TELNET	<input type="checkbox"/> Enable	<input type="checkbox"/> Enable	<input type="checkbox"/> Enable	<input type="checkbox"/> Enable	23
SSH	<input type="checkbox"/> Enable	<input type="checkbox"/> Enable	<input type="checkbox"/> Enable	<input type="checkbox"/> Enable	22
SNMP	<input type="checkbox"/> Enable	<input type="checkbox"/> Enable	<input type="checkbox"/> Enable	<input type="checkbox"/> Enable	161
PING	<input type="checkbox"/> Enable	<input type="checkbox"/> Enable	<input type="checkbox"/> Enable	<input type="checkbox"/> Enable	

- 2 Select how you want to access the Zyxel Device remotely.

### Option 1: LAN / WLAN (WiFi) Access

If you want to access the Zyxel Device remotely using the network devices connected to the same local network (LAN) or connected through WiFi (WLAN), enable the **LAN / WLAN** option. The **LAN / WLAN** option provides access to all network devices on the LAN / WLAN.

Enable the type of **Services** on the **LAN / WLAN** to allow access of the selected **Service** from the local LAN.

### Option 2: WAN Access from the Outside

If you want to access the Zyxel Device from outside the local network, enable the WAN access. This allows you to remotely access the Zyxel Device's Web Configurator using the public IPv4 / IPv6 address of your network.

Enable the type of **Services** on the WAN to allow access of the selected **Service** from the outside from all WAN connections.

### Option 3: Trust Domain

Alternatively, you can enable the **Trust Domain** feature. Manually configure a list of public IPv4 / IPv6 addresses that you trust to access the Zyxel Device from the outside. By specifying the trusted IPv4 / IPv6 addresses, this allows you add an extra layer of security to your remote management setup.

Enable the type of **Services** on the **Trust Domain** to allow access of the selected **Service** only from the trusted IPv4 / IPv6 addresses configured under **Trust Domain**.

- 3 Select how you want to access the Zyxel Device remotely.
- 4 You may change the server **Port** number for a service if needed, however you must use the same port number in order to use that service for remote management.

## 5.9.2 Configure the Trust Domain

Perform the following to configure the Trust Domain on your Zyxel Device:

- 1 Go to the **Maintenance > Remote Management > Trust Domain** screen. Click **+ Add Trust Domain** to go to the **Add Trust Domain** screen to add a trusted host IPv4 / IPv6 address.

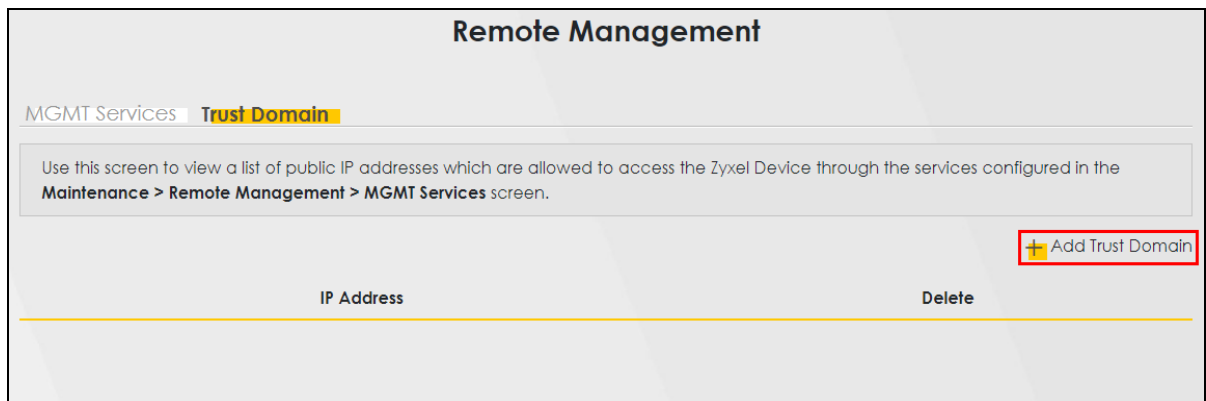

- 2 Enter a public IPv4 / IPv6 IP address which is allowed to access the service on the Zyxel Device from the WAN. Then click **OK**.

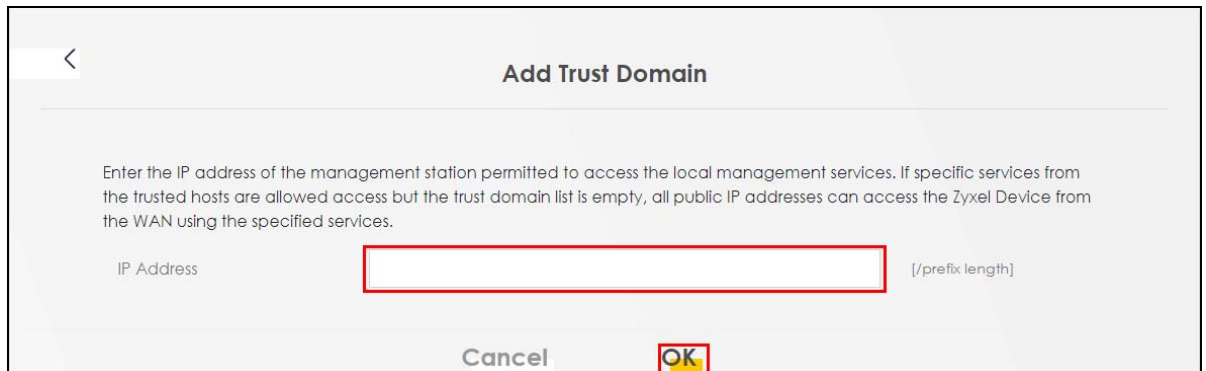

---

# PART II

# Technical Reference

---

# CHAPTER 6

## Connection Status

### 6.1 Connection Status Overview

After you log into the Web Configurator, the **Connection Status** screen appears. You can configure basic Internet access and WiFi settings in this screen. It also shows the network status of the Zyxel Device and computers or devices connected to it.

#### 6.1.1 Connectivity

Use this screen to view the network connection status of the Zyxel Device and its clients.

**Figure 54** Connectivity

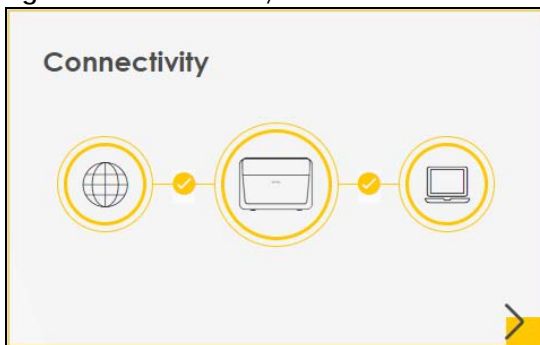

Click the Arrow icon (  ) to view IP addresses and MAC addresses of the wireless and wired devices connected to the Zyxel Device.

**Figure 55** Connectivity: Connected Devices

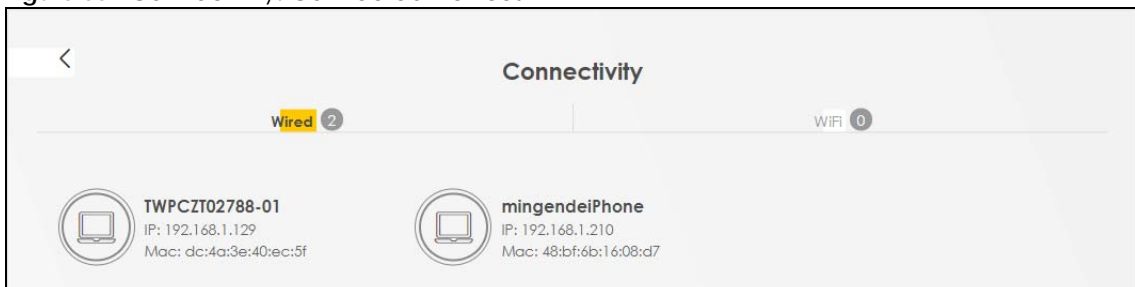

You can change the icon and name of a connected device. Place your mouse within the device block, and an Edit icon (  ) will appear. Click the Edit icon, and you will see there are several icon choices for you to select. Enter a name in the **Device Name** field for a connected device. Click to enable (  ) **Internet Blocking** for a connected WiFi client.



## 6.1.2 Icon and Device Name

Select an icon and/or enter a name in the **Device Name** field for a connected device. Click to enable () **Internet Blocking** (or **Active**) for a connected WiFi client. Click **Save** to save your changes.

**Figure 56** Connectivity: Edit

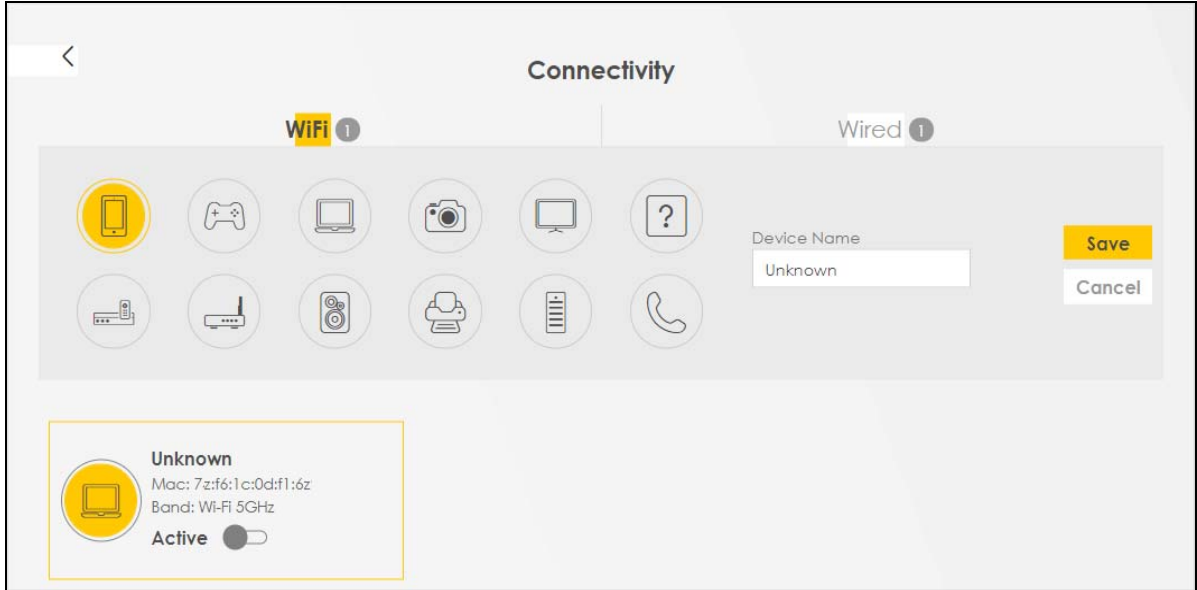

## 6.1.3 System Info

Use this screen to view the basic system information of the Zyxel Device.

**Figure 57** System Info

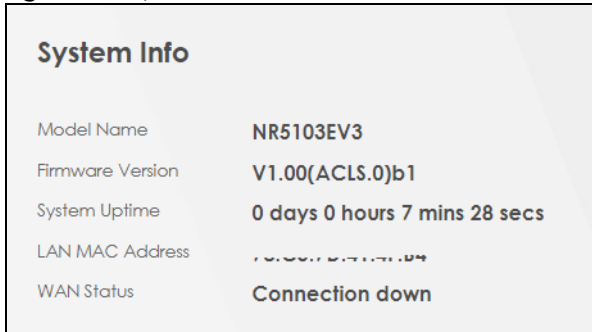

Click the Arrow icon () to view more information on the status of your firewall and interfaces (WAN, LAN, and WLAN).

Figure 58 System Info: Detailed Information



Each field is described in the following table.

Table 17 System Info: Detailed Information

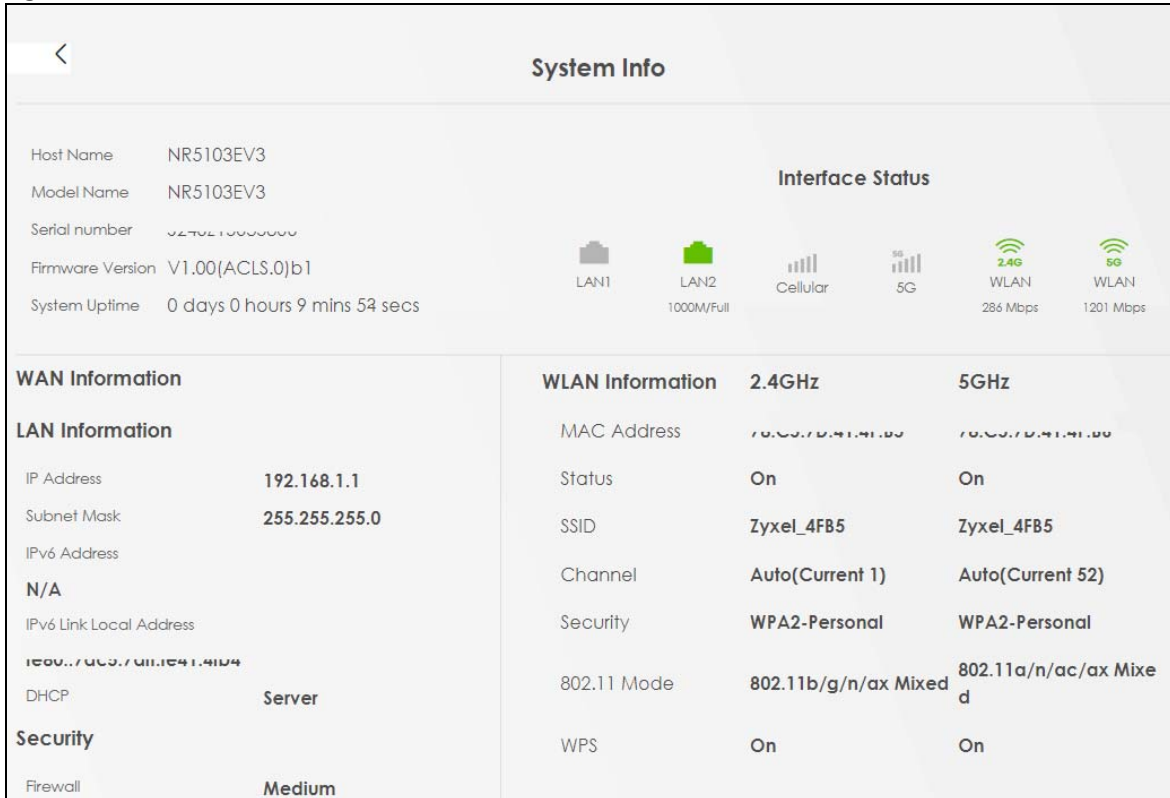
LABEL	DESCRIPTION
Host Name	This field displays the Zyxel Device system name. It is used for identification.
Model Name	This shows the model number of your Zyxel Device.
Serial Number	This field displays the serial number of the Zyxel Device.
Firmware Version	This is the current version of the firmware inside the Zyxel Device.
System Uptime	This field displays how long the Zyxel Device has been running since it last started up. The Zyxel Device starts up when you plug it in, when you restart it ( <b>Maintenance &gt; Reboot</b> ), or when you reset it.
APN	This field displays the Access Point Name (APN).
Mode	This field displays the current mode of your Zyxel Device.
Primary DNS server	This field displays the first DNS server address assigned by the ISP.
Secondary DNS server	This field displays the second DNS server address assigned by the ISP.
Primary DNSv6 server	This field displays the first DNS server IPv6 address assigned by the ISP.
Secondary DNSv6 server	This field displays the second DNS server IPv6 address assigned by the ISP.
<b>LAN Information</b>	
IP Address	This is the current IP address of the Zyxel Device in the LAN.
Subnet Mask	This is the current subnet mask in the LAN.
IPv6 Address	This is the current IPv6 address of the Zyxel Device in the LAN.

Table 17 System Info: Detailed Information (continued)

LABEL	DESCRIPTION
IPv6 Link Local Address	This field displays the current link-local address of the Zyxel Device for the LAN interface. A link-local address is a special type of the IP address that is only valid for communication within the local network segment or broadcast domain of the device. Typically, link-local addresses are used for automatic address configuration and neighbor discovery protocols.
DHCP	This field displays what DHCP services the Zyxel Device is providing to the LAN. The possible values are:  <b>Server</b> – The Zyxel Device is a DHCP server in the LAN. It assigns IP addresses to other computers in the LAN.  <b>Relay</b> – The Zyxel Device acts as a surrogate DHCP server and relays DHCP requests and responses between the remote server and the clients.  <b>Disable</b> – The Zyxel Device is not providing any DHCP services to the LAN.
Security	
Firewall	This displays the firewall's current security level ( <b>High, Medium, Low, or Disabled</b> ).
WLAN Information	
MAC Address	This shows the WiFi adapter MAC (Media Access Control) Address of the WiFi interface.
Status	This displays whether the WLAN is activated.
SSID	This is the descriptive name used to identify the Zyxel Device in a WLAN.
Channel	This is the channel number currently used by the WiFi interface.
Security	This displays the type of security mode the WiFi interface is using in the WLAN.
802.11 Mode	This displays the type of 802.11 mode the WiFi interface is using in the WLAN.
WPS	This displays whether WPS is activated on the WiFi interface.

## 6.1.4 Cellular Info

Use this screen to view cellular connection information, details on signal strength that you can use as a reference for positioning the Zyxel Device. SIM card and module information is also shown in the screen.

Figure 59 Cellular Info

Cellular Info	
Mode	<b>Router Mode</b>
Status	<b>Up</b>
IP Address	<b>10.54.53.164</b>
Primary DNS server	<b>210.241.208.1,139.175.1.2</b>
IPv6 Address	<b>2401:e180:8d21:11d5:38b8:4aff:fe61:2a26</b>
Primary DNSv6 server	<b>2401:e180:7fff::210:241:208:1 , 2001:cd8:103::139:175:1:1</b>
Access Technology	<b>NR5G-NSA</b>
Signal Strength	<b>-75</b>

Click the Arrow icon (  ) to view the more information on the cellular connection.

Figure 60 Cellular Info: Detailed Information

Module Information		Service Information	
IMEI	251000770000518	Access Technology	LTE
Module SW Version	RG500LEUACR04A01M1G	Band	B7
SIM Status		RSSI (dBm)	-93
SIM Card Status	Available	Cell ID	88587328
IMSI	466924293329988	Physical Cell ID	164
ICCID	89886920042933299880	UL Bandwidth (MHz)	20M
PIN Protection	Disable	DL Bandwidth (MHz)	20M
PIN Remaining Attempts	3	RFCN	3050
IP Passthrough Status		RSRP (dBm)	-101
IP Passthrough Enable	Disable	RSRQ (dB)	-8
Cellular Status		RSCP	0
Cellular Status	Up	EcNo	0
Data Roaming	Disable	Primary Scrambling Code	
Operator	Chunghwa Telecom	LAC	N/A
PLMN	46692	RAC	N/A
Antenna Status	Internal	SINR (dB)	12
		NR Physical Cell ID	N/A
		NR RSRP	0
		NR RSRQ	0
		NR SINR (dBm)	0
		TAC	13700

The following table describes the labels in this screen.

Table 18 Cellular Info: Detailed Information

LABEL	DESCRIPTION
Module Information	
IMEI	This shows the International Mobile Equipment Identity of the Zyxel Device.
Module SW Version	This shows the software version of the cellular network module.
SIM Status	
SIM Card Status	This displays the SIM card status: <b>None</b> – the Zyxel Device does not detect that there is a SIM card inserted. <b>Available</b> – the SIM card could either have or does not have PIN code security. <b>Locked</b> – the SIM card has PIN code security, but you did not enter the PIN code yet. <b>Blocked</b> – you entered an incorrect PIN code too many times, so the SIM card has been locked; call the ISP for a PUK (Pin Unlock Key) to unlock the SIM card. <b>Error</b> – the Zyxel Device detected that the SIM card has errors.
IMSI	This displays the International Mobile Subscriber Identity (IMSI) of the installed SIM card. An IMSI is a unique ID used to identify a mobile subscriber in a mobile network.
ICCID	Integrated Circuit Card Identifier (ICCID). This is the serial number of the SIM card.

Table 18 Cellular Info: Detailed Information (continued)

LABEL	DESCRIPTION
PIN Protection	A PIN (Personal Identification Number) code is a key to a SIM card. Without the PIN code, you cannot use the SIM card.  Shows <b>Enable</b> if the service provider requires you to enter a PIN to use the SIM card.  Shows <b>Disable</b> if the service provider lets you use the SIM without inputting a PIN.
PIN Remaining Attempts	This is how many more times you can try to enter the PIN code before the ISP blocks your SIM card.
IP Passthrough Status	
IP Passthrough Enable	This displays if IP Passthrough is enabled on the Zyxel Device.  IP Passthrough allows a LAN computer on the local network of the Zyxel Device to have access to web services using the public IP address. When IP Passthrough is configured, all traffic is forwarded to the LAN computer and will not go through NAT.
Cellular Status	
Cellular Status	This displays the status of the cellular Internet connection.
Data Roaming	This displays if data roaming is enabled on the Zyxel Device.  Data roaming is to use your Zyxel Device in an area which is not covered by your service provider. Enable roaming to ensure that your Zyxel Device is kept connected to the Internet when you are traveling outside the geographical coverage area of the network to which you are registered.
Operator	This displays the name of the service provider.
PLMN	This displays the PLMN (Public Land Mobile Network) number.
Antenna Status	This displays <b>Internal</b> when you are using the Zyxel Device's built-in antenna for cellular signal. This displays <b>External</b> when you install the external antennas to strengthen the cellular signal.
NR-NSA Information	
MCC	This shows the Mobile Country Code (MCC). MCC is a unique code that identifies the country where a Public Land Mobile Network (PLMN) is at.
MNC	This shows the Mobile Network Code (MNC). MNC is a unique code that identifies a Public Land Mobile Network (PLMN) in a country. MCC and MNC combined together are used to identify a globally unique PLMN.
Service Information	
Note: If the cellular service provider supports carrier aggregation (CA), then this section displays statistics for the connection's primary component carrier (PCC).	
Access Technology	This displays the type of the mobile network (such as LTE, UMTS, GSM) to which the Zyxel Device is connecting.
Band	This displays the current cellular band of your Zyxel Device (WCDMA2100).
RSSI (dBm)	This displays the strength of the cellular signal between an associated cellular station and the Zyxel Device.
Cell ID	This shows the cell ID, which is a unique number used to identify the Base Transceiver Station to which the Zyxel Device is connecting.  The value depends on the type of the mobile network (such as LTE, UMTS, GSM) to which the Zyxel Device is connecting: <ul style="list-style-type: none"> <li>For UMTS, it is the Cell Identity as defined in SIB3 3GPP-TS.25.331, 3GPP-TS.24.008.</li> <li>For LTE/5G, it is the 28-bit binary number Cell Identity as specified in SIB1 in 3GPP-TS.36.331.</li> </ul> The value is '0' (zero) or 'N/A' if there is no network connection.
Physical Cell ID	This shows the Physical Cell ID (PCI), which are queries and replies between the Zyxel Device and the mobile network it is connecting to. The normal range is 1 to 504.

Table 18 Cellular Info: Detailed Information (continued)

LABEL	DESCRIPTION
UL Bandwidth (MHz)	This shows the uplink cellular channel bandwidth from the Zyxel Device to the base station. According to 3GPP specifications, the bandwidths defined by the standard are 1.4, 3, 5, 10, 15, and 20 MHz. The wider the bandwidth the higher the throughput.
DL Bandwidth (MHz)	This shows the downlink cellular channel bandwidth from the base station to the Zyxel Device. According to 3GPP specifications, the bandwidths defined by the standard are 1.4, 3, 5, 10, 15, and 20 MHz. The wider the bandwidth the higher the throughput.
RFCN	<p>This displays the Radio Frequency Channel Number of DL carrier frequency used by the mobile network to which the Zyxel Device is connecting.</p> <p>The value depends on the type of the mobile network (such as LTE, UMTS, GSM) to which the Zyxel Device is connecting:</p> <ul style="list-style-type: none"> <li>• For UMTS (3G), it is the UARFCN (UTRA Absolute Radio-Frequency Channel Number) as specified in 3GPP-TS.25.101.</li> <li>• For LTE/5G, it is the EARFCN (E-UTRA Absolute Radio-Frequency Channel Number) as specified in 3GPP-TS.36.101.</li> </ul> <p>The value is '0' (zero) or 'N/A' if there is no network connection.</p>
RSRP (dBm)	<p>This displays the Reference Signal Receive Power (RSRP), which is the average received power of all Resource Element (RE) that carry cell-specific Reference Signals (RS) within the specified bandwidth.</p> <p>The received RSRP level of the connected E-UTRA cell, in dBm, is as specified in 3GPP-TS.36.214. The reporting range is specified in 3GPP-TS.36.133.</p> <p>An undetectable signal is indicated by the lower limit, example -140 dBm.</p> <p>This parameter is for LTE only. The normal range is -44 to -140. The signal is better when the value is closer to -44. The value is -140 if the Current Access Technology is not LTE. The value is 'N/A' if there is no network connection.</p>
RSRQ (dB)	<p>This displays the Reference Signal Receive Quality (RSRQ), which is the ratio of RSRP to the E-UTRA carrier RSSI and indicates the quality of the received reference signal.</p> <p>The received RSRQ level of the connected E-UTRA cell, in 0.1 dB, is as specified in 3GPP-TS.36.214. An undetectable signal is indicated by the lower limit, example -240.</p> <p>This parameter is for LTE only. The normal range is -30 to -240. The value is -240 if the Current Access Technology is not LTE. The value is 'N/A' if there is no network connection.</p>
RSCP	<p>This displays the Received Signal Code Power, which measures the power of channel used by the Zyxel Device.</p> <p>The received signal level, in dBm, is of the CPICH channel (Ref. 3GPP TS 25.133). An undetectable signal is indicated by the lower limit, example -120 dBm.</p> <p>This parameter is for UMTS only. The normal range is -30 to -120. The value is -120 if the Current Access Technology is not UMTS. The value is 'N/A' if there is no network connection.</p>
EcNo	<p>This displays the ratio (in dB) of the received energy per chip and the interference level.</p> <p>The measured EcNo is in 0.1 dB and is received in the downlink pilot channel. An undetectable signal is indicated by the lower limit, example -240 dB.</p> <p>This parameter is for UMTS only. The normal range is -30 to -240. The value is -240 if the Current Access Technology is not UMTS or there is no network connection.</p>
Primary Scrambling Code	<p>This displays a unique scrambling code used by the Nebula Device to identify a base station in a cellular network.</p> <p>A primary scrambling code is the product of the scrambling code and 16. Therefore, the primary scrambling code set contains all multiples of 16 from 0 through 8176.</p> <p>Note: This only appears in UMTS mode. Otherwise, this field is blank.</p>

Table 18 Cellular Info: Detailed Information (continued)

LABEL	DESCRIPTION
LAC	<p>This displays the 2-octet Location Area Code (LAC), which is used to identify a location area within a PLMN.</p> <p>The LAC of the connected cell is as defined in SIB 1 [3GPP-TS.25.331]. The concatenation of PLMN ID (MCC+MNC) and LAC uniquely identifies the LAI (Location Area ID) [3GPP-TS.23.003].</p> <p>This parameter is for UMTS or GPRS. The value is '0' (zero) if the Current Access Technology is not UMTS or GPRS. The value is 'N/A' if there is no network connection.</p>
RAC	<p>This displays the RAC (Routing Area Code), which is used in mobile network "packet domain service" (PS) to identify a routing area within a location area.</p> <p>In a mobile network, the Zyxel Device uses LAC (Location Area Code) to identify the geographical location for the old 3G voice only service, and uses RAC to identify the location of data service like HSDPA or LTE.</p> <p>The RAC of the connected UTRAN cell is as defined in SIB 1 [3GPP-TS.25.331]. The concatenation of PLMN ID (MCC+MNC), LAC, and RAC uniquely identifies the RAI (Routing Area ID) [3GPP-TS.23.003].</p> <p>This parameter is for UMTS or GPRS. The value is '0' (zero) if the Current Access Technology is not UMTS or GPRS. The value is 'N/A' if there is no network connection.</p>
BSIC	<p>The Base Station Identity Code (BSIC), which is a code used in GSM to uniquely identify a base station.</p> <p>This parameter is for GPRS only. The value is '0' (zero) if the Current Access Technology is not GPRS. The value is 'N/A' if there is no network connection.</p>
SINR (dB)	This displays the Signal to Interference plus Noise Ratio (SINR) in dB. This is also a measure of signal quality and used by the UE (User Equipment) to calculate the Channel Quality Indicator (CQI) that it reports to the network. A negative value means more noise than signal.
CQI	This displays the Channel Quality Indicator (CQI). It is an indicator carrying the information on how good or bad the communication channel quality is.
MCS	MCS stands for modulation coding scheme. The base station selects MCS based on current radio conditions. The higher the MCS the more bits can be transmitted per time unit.
RI	This displays the Rank Indication, one of the control information that a UE will report to eNodeB (Evolved Node-B) on either PUCCH (Physical Uplink Control Channel) or PUSCH (Physical Uplink Shared Channel) based on uplink scheduling.
PMI	<p>This displays the Precoding Matrix Indicator (PMI).</p> <p>PMI is for transmission modes 4 (closed loop spatial multiplexing), 5 (multi-user MIMO), and 6 (closed loop spatial multiplexing using a single layer).</p> <p>PMI determines how cellular data are encoded for the antennas to improve downlink rate.</p>
SCC Information	If the cellular service provider supports carrier aggregation (CA), then this section displays statistics for the connection's secondary component carriers (SCCs).
#	This displays the ID of the SCC. Some cellular providers support two or more SCCs.
NR Physical Cell ID	This displays the Physical Cell ID (PCI) of the SCC.
RFCN	This displays the Radio Frequency Channel Number of DL carrier frequency used by the SCC.
Band	This displays the current cellular band used by the SCC.
RSSI	This displays the cellular signal strength between an associated cellular station and the Zyxel Device for this SCC.
NR RSRP	This displays the Received Signal Code Power of the SCC.
NR RSRQ	This displays the Reference Signal Receive Quality of the SCC.

Table 18 Cellular Info: Detailed Information (continued)

LABEL	DESCRIPTION
NR SINR (dBm)	This displays the Signal to Interference plus Noise Ratio (SINR) of the SCC.
TAC	This displays the Tracking Area Code (TAC), which is used to identify the country of a mobile subscriber.  The physical cell ID of the connected E-UTRAN cell, is as specified in 3GPP-TS.36.101.  This parameter is for LTE only. The value is '0' (zero) or 'N/A' if the Current Access Technology is not LTE or there is no network connection.

## 6.1.5 WiFi Settings

Use this screen to enable or disable the main WiFi network. When the switch turns blue, the function is enabled. You can use this screen or the QR code on the upper right corner to check the SSIDs (WiFi network name) and passwords of the main WiFi networks. If you want to show or hide your WiFi passwords, click the Eye icon (👁).

Figure 61 WiFi Settings

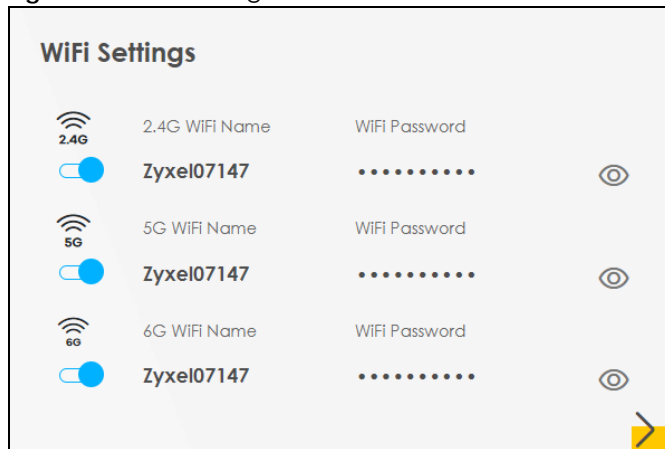

Click the Arrow icon (➤) to configure the SSIDs and/or passwords for your main WiFi networks. Click the Eye icon (👁) to display the characters as you enter the WiFi Password.

Scanning the QR code is an alternative way to connect your WiFi client to the WiFi network.

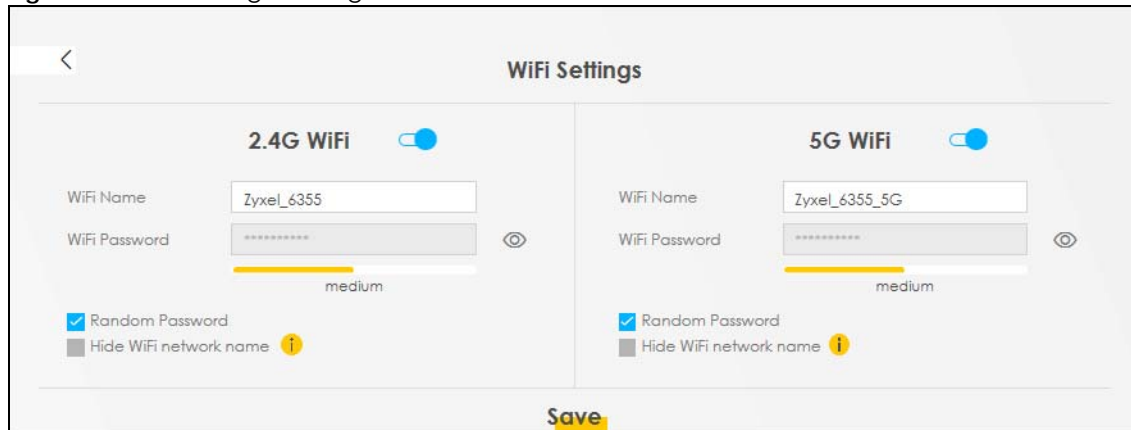

Figure 62 WiFi Settings: Configuration





Each field is described in the following table.

Table 19 WiFi Settings: Configuration

LABEL	DESCRIPTION
2.4G / 5G / 6G WiFi	Click this switch to enable or disable the 2.4G / 5G / 6G WiFi network. When the switch turns blue  , the function is enabled.
WiFi Name	The SSID (Service Set IDentity) identifies the service set with which a WiFi device is associated. WiFi devices associating to the access point (AP) must have the same SSID.  Enter a descriptive name for the WiFi. You can use up to 32 printable characters, including spaces.
WiFi Password	If you selected <b>Random Password</b> , this field displays a pre-shared key generated by the Zyxel Device.  If you did not select <b>Random Password</b> , you can manually enter a pre-shared key from 8 to 63 alphanumeric (0-9, a-z, A-Z) and special characters, including spaces.  Click the Eye icon to show or hide the password for your WiFi network. When the Eye icon is slashed  , you will see the password in plain text. Otherwise, it is hidden.
Random Password	Select this to have the Zyxel Device automatically generate a password. The <b>WiFi Password</b> field will not be configurable when you select this option.
Hide WiFi network name	Select this to hide the SSID in the outgoing beacon frame so a station cannot obtain the SSID through scanning using a site survey tool.  Note: Disable WPS in the <b>Network Setting &gt; Wireless &gt; WPS</b> screen to hide the SSID.
Save	Click <b>Save</b> to save your changes.

## 6.2 Guest WiFi Settings

Use this screen to enable or disable the guest 2.4 GHz / 5 GHz / 6GHz WiFi networks. When the switch goes to the right () , the function is enabled. Otherwise, it is not. You can check their SSIDs (WiFi network name) and passwords from this screen. If you want to show or hide your WiFi passwords, click the Eye icon.

Figure 63 Guest WiFi Settings



Click the Arrow icon (➤) to open the following screen. Use this screen configure the SSIDs and/or passwords for your guest WiFi networks.

**Figure 64** Guest WiFi Settings: Configuration

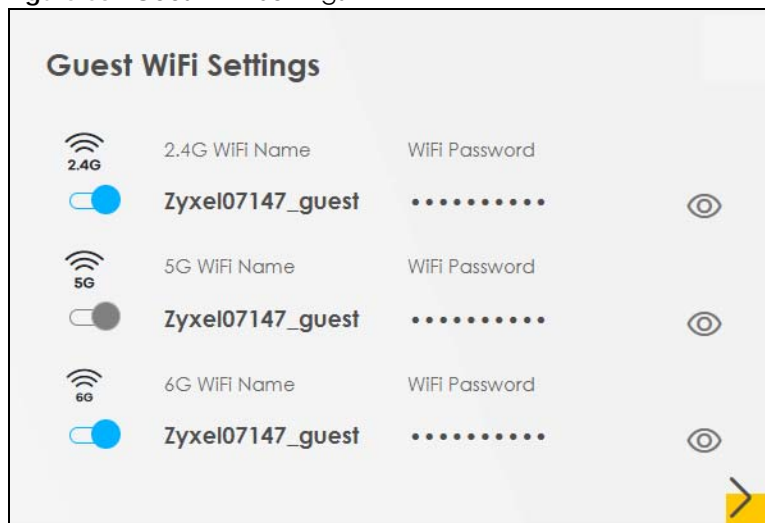
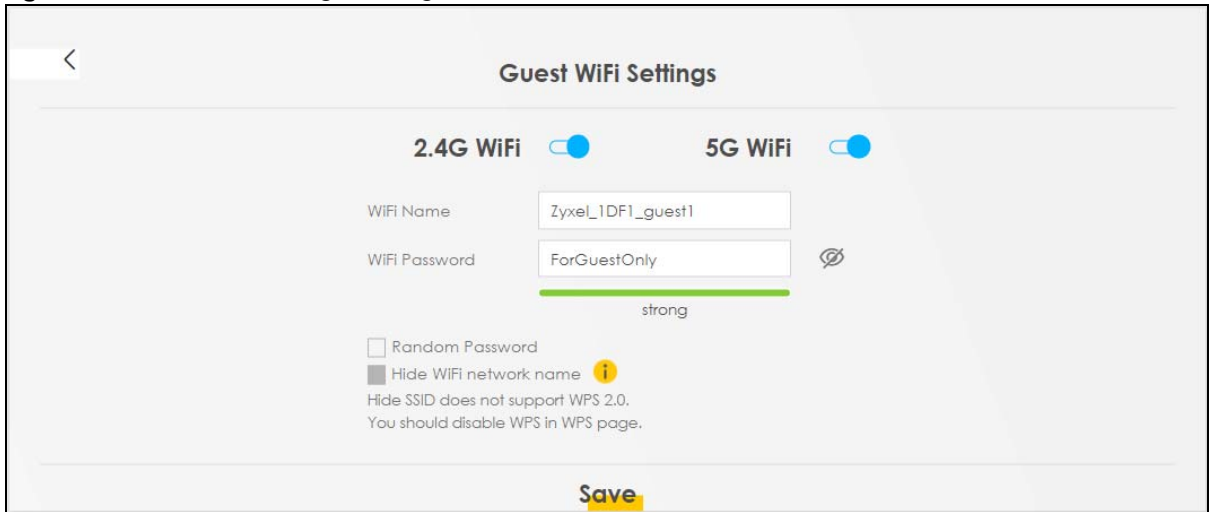

To assign different SSIDs to the 2.4 GHz and 5 GHz guest wireless networks, clear the **Keep 2.4G, 5G and 6G the same** checkbox in the **WiFi Settings** screen, and the **Guest WiFi Settings** screen will change.

**Figure 65** Guest WiFi Settings: Different SSIDs

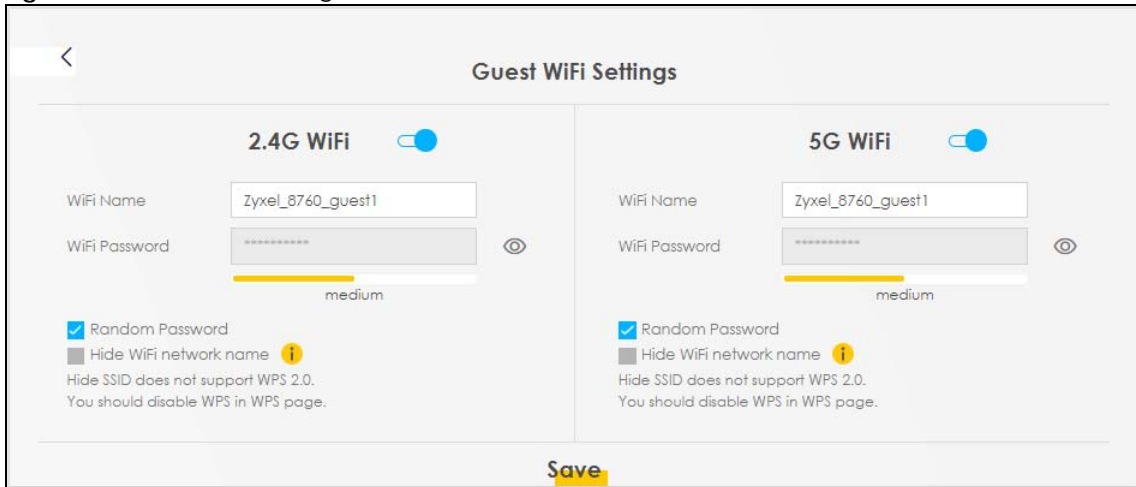

Each field is described in the following table.

Table 20 WiFi Settings: Configuration



LABEL	DESCRIPTION
2.4G/5G/6G WiFi	Click this switch to enable or disable the 2.4 GHz / 5 GHz / 6 GHz WiFi networks. When the switch goes to the right  , the function is enabled. Otherwise, it is not.
WiFi Name	The SSID (Service Set IDentity) identifies the service set with which a wireless device is associated. Wireless devices associating to the access point (AP) must have the same SSID. Enter a descriptive name (up to 32 printable characters, including spaces) for the WiFi.

Table 20 WiFi Settings: Configuration (continued)

LABEL	DESCRIPTION
WiFi Password	If you selected <b>Random Password</b> , this field displays a pre-shared key generated by the Zyxel Device.  If you did not select <b>Random Password</b> , you can manually enter a pre-shared key from 8 to 64 alphanumeric (0-9, a-z, A-Z) and special characters, including spaces.
	Click the Eye icon to show or hide the password of your WiFi network. When the Eye icon is slashed  , you will see the password in plain text. Otherwise, it is hidden.
Random Password	Select this option to have the Zyxel Device automatically generate a password. The <b>WiFi Password</b> field will not be configurable when you select this option.
Hide WiFi network name	Select this checkbox to hide the SSID in the outgoing beacon frame so a station cannot obtain the SSID through scanning using a site survey tool.  Note: Disable WPS in the <b>Network Setting &gt; Wireless &gt; WPS</b> screen to hide the SSID.
Save	Click <b>Save</b> to save your changes.

## 6.2.1 LAN

Use this screen to view the LAN IP address, subnet mask, and DHCP settings of your Zyxel Device. Click the switch button to turn on/off the DHCP server.

Figure 66 LAN

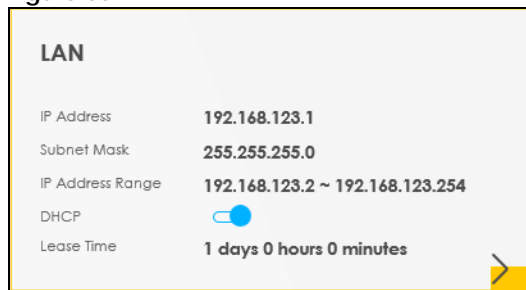

Click the Arrow icon () to configure the LAN IP settings and DHCP setting for your Zyxel Device.

Figure 67 LAN Setup

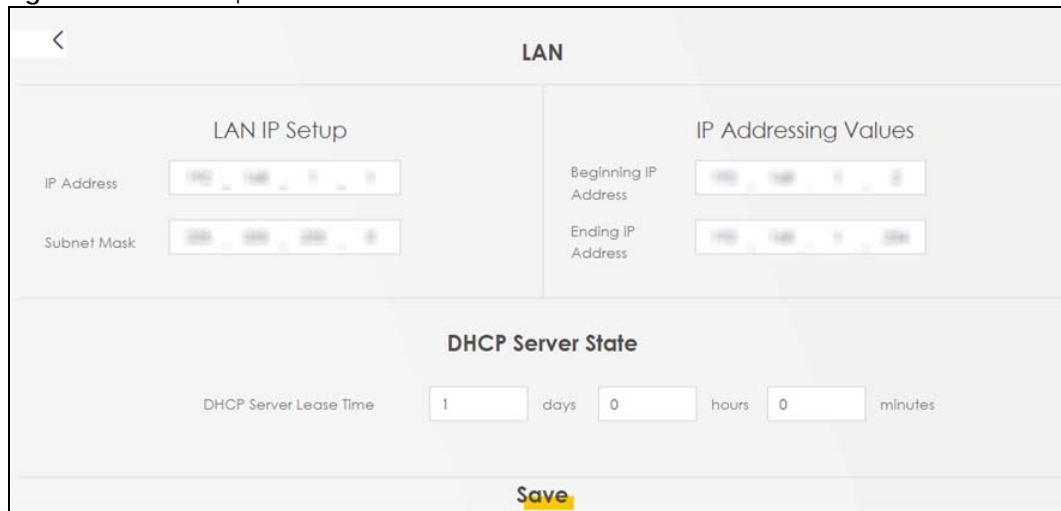

Each field is described in the following table.

Table 21 LAN Setup

LABEL	DESCRIPTION
LAN IP Setup	
IP Address	Enter the LAN IPv4 IP address you want to assign to your Zyxel Device in dotted decimal notation, for example, (factory default).
Subnet Mask	Enter the subnet mask of your network in dotted decimal notation, for example 255.255.255.0 (factory default). Your Zyxel Device automatically computes the subnet mask based on the IP Address you enter, so do not change this field unless you are instructed to do so.
IP Addressing Values	
Beginning IP Address	This field specifies the first of the contiguous addresses in the IP address pool.
Ending IP Address	This field specifies the last of the contiguous addresses in the IP address pool.
DHCP Server State	
DHCP Server Lease Time	This is the period of time a DHCP-assigned address is valid, before it expires.  When a client connects to the Zyxel Device, DHCP automatically assigns the client an IP addresses from the IP address pool. DHCP leases each addresses for a limited period of time, which means that past addresses are "recycled" and made available for future reassignment to other devices.
Days/Hours/Minutes	Enter the lease time of the DHCP server.

# CHAPTER 7

## Broadband

### 7.1 Broadband Overview

This chapter discusses the Zyxel Device's **Broadband** screens. Use these screens to configure your Zyxel Device for Internet access.

A WAN (Wide Area Network) connection is an outside connection to another network or the Internet. It connects your private networks, such as a LAN (Local Area Network) and other networks, so that a computer in one location can communicate with computers in other locations.

**Figure 68** LAN and WAN

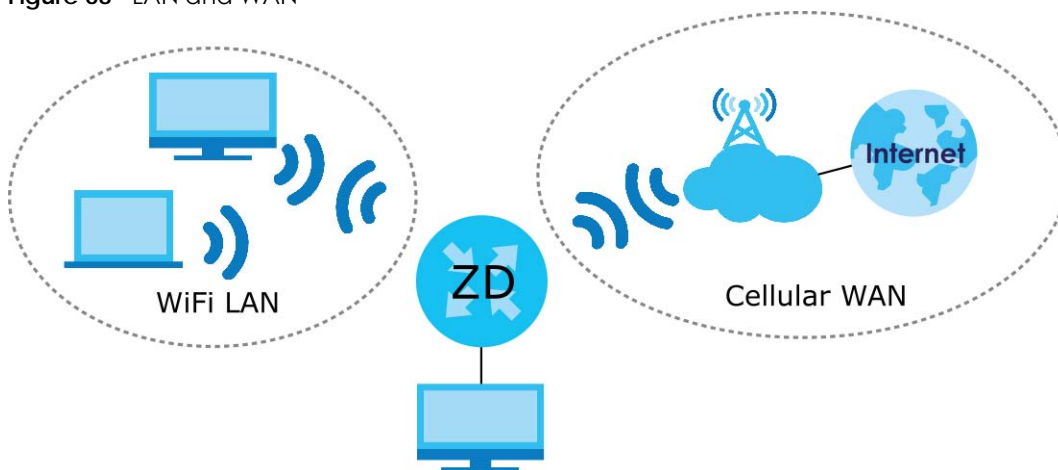

#### 7.1.1 What You Can Do in this Chapter

- Use the **Broadband** screen to view a WAN interface. You can also configure the WAN settings on the Zyxel Device for Internet access ([Section 7.2 on page 119](#)).
- Use the **WAN Backup** screen to configure your Zyxel Device's WAN backup settings ([Section 7.4 on page 125](#)).
- Use the **Ethernet WAN** screen to convert LAN port number four as a WAN port or restore the Ethernet WAN port to a LAN port ([Section 7.4 on page 125](#)).
- Use the **Cellular WAN** screen to configure a cellular WAN connection ([Section 7.5 on page 126](#)).
- Use the **Cellular APN** screen to configure the APN setting ([Section 7.6 on page 127](#)).
- Use the **Cellular SIM** screen to enter the PIN of your SIM card ([Section 7.7 on page 131](#)).
- Use the **Cellular Band** screen to view or edit a cellular WAN interface. You can also configure the WAN settings on the Zyxel Device for Internet access ([Section 7.8 on page 133](#)).
- Use the **Cellular PLMN** screen to display available Public Land Mobile Networks ([Section 7.9 on page 133](#)).
- Use the **Cellular IP Passthrough** screen to configure a cellular WAN connection ([Section 7.10 on page 136](#)).

- Use the **Cellular SMS** screen to send and receive SMS messages from the Zyxel Device ([Section 7.11 on page 137](#)).

Table 22 WAN Setup Overview

LAYER-2 INTERFACE		INTERNET CONNECTION		
CONNECTION	DSL LINK TYPE	MODE	ENCAPSULATION	CONNECTION SETTINGS
Ethernet	N/A	Routing	IPoE	WAN IPv4/IPv6 IP address, NAT, DNS server and routing feature.

## 7.1.2 What You Need to Know

The following terms and concepts may help as you read this chapter.

### WAN IP Address

The WAN IP address is an IP address for the Zyxel Device, which makes it accessible from an outside network. It is used by the Zyxel Device to communicate with other devices in other networks. The ISP dynamically assigns it each time the Zyxel Device tries to access the Internet.

### APN

An Access Point Name (APN) is the name of a gateway between a cellular network and another network, such as the Internet. The Zyxel Device requires an APN to connect to a cellular network. Different APNs may provide different services, such as Internet access or MMS (Multi-Media Messaging Service), and different charging methods.

### 464XLAT

Enable 464XLAT to send IPv4 traffic through the Zyxel Device when the Zyxel Device has an IPv6 WAN address.

464XLAT sends traffic from an IPv4 private network to another IPv4 network across an IPv6-only network. The Zyxel Device acts as a Customer-side Translator (CLAT). The CLAT adds an IPv6 prefix to the outgoing IPv4 packets, encapsulating IPv4 addresses as IPv6 addresses. When the packets go through the IPv6-only network, a Provider-side Translator (PLAT) removes the IPv6 prefixes so as the IPv4 addresses can reach the target IPv4 network.

Figure 69 464XLAT

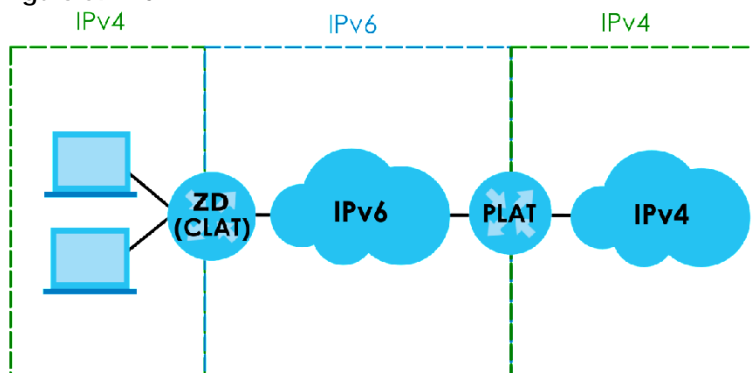

### 7.1.3 Before You Begin

You may need to know your Internet access settings such as APN, WAN IP address and SIM card's PIN code if the **INTERNET** light on your Zyxel Device is off. Get this information from your service provider.

## 7.2 Broadband

Use this screen to change your Zyxel Device's Internet access settings. The summary table shows you the configured WAN services (connections) on the Zyxel Device. Use information provided by your ISP to configure WAN settings.

Click **Network Setting > Broadband** to access this screen.

**Figure 70** Network Setting > Broadband

#	Name	Type	Mode	Encapsulation	802.1p	802.1q	IGMP Proxy	NAT	Default Gateway	IPv6	MLD Proxy	Modify
1	Cellular WAN 1	CELL	Routing	IPoE	N/A	N/A	N	Y	Y	Y	N	
2	Cellular WAN 2	CELL	Routing	IPoE	N/A	N/A	N	Y	N	Y	N	
3	ETHWAN	ETH	Routing	IPoE	N/A	N/A	Y	Y	Y	Y	Y	

The following table describes the labels in this screen.

**Table 23** Network Setting > Broadband

LABEL	DESCRIPTION
#	This is the index number of the entry.
Name	This is the service name of the connection.
Type	This shows whether it is a cellular or Ethernet connection.
Mode	This shows the connection is in routing mode.
Encapsulation	This is the method of encapsulation used by this connection.
802.1p	This indicates the 802.1p priority level assigned to traffic sent through this connection. This displays <b>N/A</b> when there is no priority level assigned.
802.1q	This indicates the VLAN ID number assigned to traffic sent through this connection. This displays <b>N/A</b> when there is no VLAN ID number assigned.
IGMP Proxy	This shows whether the Zyxel Device act as an IGMP proxy on this connection.
NAT	This shows whether NAT is activated or not for this connection.

Table 23 Network Setting &gt; Broadband (continued)

LABEL	DESCRIPTION
Default Gateway	This shows whether the Zyxel Device use the WAN interface of this connection as the default gateway.
IPv6	This shows whether IPv6 is activated or not for this connection. IPv6 is not available when the connection uses the bridging service.
MLD Proxy	This shows whether Multicast Listener Discovery (MLD) is activated or not for this connection. MLD is not available when the connection uses the bridging service.
Modify	Click the <b>Modify</b> icon to configure the WAN connection. Click the <b>Delete</b> icon to remove the WAN connection.

## 7.2.1 Add or Edit Internet Connection

Click the **Edit** or **Modify** icon next to a WAN interface to open the following screen. Use this screen to configure a WAN connection.



Figure 71 Network Setting > Broadband > Add or Edit New WAN Interface

The screenshot shows the 'Edit WAN Interface' configuration page. At the top, there is a back arrow and the title 'Edit WAN Interface'. The page is organized into a grid of sections:

- General:** Includes a toggle switch for the interface, and fields for Name (Cellular WAN), Type, Mode (Routing), Encapsulation (IPoE), and IPv4/IPv6 Mode (IPv4 IPv6 DualStack).
- VLAN:** Includes fields for 802.1p (0) and 802.1q, and a range indicator [1~4094].
- MTU:** Includes a field for MTU (1500).
- IP Address:** Includes radio buttons for 'Obtain an IP Address Automatically' (selected) and 'Static IP Address'.
- DNS Server:** Includes radio buttons for 'Obtain DNS Info Automatically' (selected) and 'Use Following Static DNS Address'.
- DHCP Options:** Includes 'Request Options' (option 43, 120, 121) and 'Sent Options' (option 60, 61, 125) with corresponding input fields for Vendor ID, IAID, and DUID.
- IPv6 Address:** Includes radio buttons for 'Obtain an IPv6 Address Automatically' (selected) and 'Static IPv6 Address'.
- IPv6 DNS Server:** Includes radio buttons for 'Obtain IPv6 DNS Info Automatically' (selected) and 'Use Following Static IPv6 DNS Address'.
- IPv6 Routing Feature:** Includes toggle switches for MLD Proxy and 'Apply as Default Gateway'.
- NAT:** Includes toggle switches for NAT, IGMP Proxy, and Fullcone NAT.
- Routing Feature:** Includes a toggle switch for 'Apply as Default Gateway'.

At the bottom of the screen, there are 'Cancel' and 'Apply' buttons.

The following table describes the labels in this screen.

Table 24 Network Setting > Broadband > Add or Edit New WAN Interface

LABEL	DESCRIPTION
General	Click this switch to enable or disable the WAN interface.
Name	This is the service name of the connection.
Type	This shows the type of the connection the Zyxel Device is currently associated with.
Mode	This shows the connection is in <b>Routing</b> or <b>Bridge</b> mode. If the Zyxel Device is in routing mode, your ISP gives you one IP address only and you want multiple computers to share an Internet account.
Encapsulation	This is the method of encapsulation used by this connection.

Table 24 Network Setting &gt; Broadband &gt; Add or Edit New WAN Interface (continued)

LABEL	DESCRIPTION
IPv4/IPv6 Mode	This shows <b>IPv4 IPv6 DualStack</b> . IPv4 IPv6 DualStack allows the Zyxel Device to run IPv4 and IPv6 at the same time.
VLAN	Click this switch to enable or disable VLAN on this WAN interface.
802.1p	IEEE 802.1p defines up to 8 separate traffic types by inserting a tag into a MAC-layer frame that contains bits to define class of service.  Select the IEEE 802.1p priority level (from 0 to 7) to add to traffic through this connection. The greater the number, the higher the priority level.
802.1q	Enter the VLAN ID number (from 1 to 4094) for traffic through this connection.
MTU	
MTU	Enter the MTU (Maximum Transfer Unit) size for this traffic.
IP Address	
Obtain an IP Address Automatically	A static IP address is a fixed IP that your ISP gives you. A dynamic IP address is not fixed; the ISP assigns you a different one each time you connect to the Internet. Select this if you have a dynamic IP address.
Static IP Address	Select this option if the ISP assigned a fixed IP address.
IP Address	Enter the static IP address provided by your ISP.
Subnet Mask	Enter the subnet mask provided by your ISP.
Gateway IP Address	Enter the gateway IP address provided by your ISP.
DNS Server	
	Select <b>Obtain DNS Info Automatically</b> if you want the Zyxel Device to use the DNS server addresses assigned by your ISP.  Select <b>Use Following Static DNS Address</b> if you want the Zyxel Device to use the DNS server addresses you configure manually.
Primary DNS Server	Enter the first DNS server address assigned by the ISP.
Secondary DNS Server	Enter the second DNS server address assigned by the ISP.
Routing Feature	
NAT	Click this switch to activate or deactivate NAT on this connection.
IGMP Proxy	Internet Group Multicast Protocol (IGMP) is a network-layer protocol used to establish membership in a Multicast group – it is not used to carry user data.  Click this switch to have the Zyxel Device act as an IGMP proxy on this connection.  This allows the Zyxel Device to get subscribing information and maintain a joined member list for each Multicast group. It can reduce Multicast traffic significantly.
Apply as Default Gateway	Click this switch to enable the Zyxel Device to use the WAN interface of this connection as the system default gateway.
Fullcone NAT	Click this switch to enable or disable fullcone NAT on this connection.  This field is available only when you activate <b>NAT</b> .  In fullcone NAT, the Zyxel Device maps all outgoing packets from an internal IP address and port to a single IP address and port on the external network. The Zyxel Device also maps packets coming to that external IP address and port to the internal IP address and port.
DHCP Options	

Table 24 Network Setting &gt; Broadband &gt; Add or Edit New WAN Interface (continued)

LABEL	DESCRIPTION
Request Options	<p>Select <b>Option 43</b> to have the Zyxel Device get vendor specific information from DHCP packets sent from the DHCP server.</p> <p>Select <b>Option 120</b> to have the Zyxel Device get an IP address or a fully-qualified domain name of a SIP server from DHCP packets sent from the DHCP server.</p> <p>Select <b>Option 121</b> to have the Zyxel Device get static route information from DHCP packets sent from the DHCP server.</p>
Sent Options	
option 60	Select this and enter the device identity you want the Zyxel Device to add in the DHCP discovery packets that go to the DHCP server.
Vendor ID	Enter the Vendor Class Identifier, such as the type of the hardware or firmware.
option 61	Select this and enter any string that identifies the device.
IAID	Enter the Identity Association Identifier (IAID) of the device, for example, the WAN connection index number.
DUID	Enter the hardware type, a time value and the MAC address of the device.
option 125	Select this to have the Zyxel Device automatically generate and add vendor specific parameters in the DHCP discovery packets that go to the DHCP server.
IPv6 Address	
Obtain an IPv6 Address Automatically	Select <b>Obtain an IPv6 Address Automatically</b> if you want to have the Zyxel Device use the IPv6 prefix from the connected router's Router Advertisement (RA) to generate an IPv6 address.
Static IPv6 Address	Select <b>Static IPv6 Address</b> if you have a fixed IPv6 address assigned by your ISP. When you select this, the following fields appear.
IPv6 Address	Enter an IPv6 IP address that your ISP gave to you for this WAN interface.
Prefix Length	Enter the address prefix length to specify how many most significant bits in an IPv6 address compose the network address.
IPv6 Default Gateway	Enter the IP address of the next-hop gateway. The gateway is a router or switch on the same segment as your Zyxel Device's interfaces. The gateway helps forward packets to their destinations.
IPv6 DNS Server	
Obtain IPv6 DNS Info Automatically	Select <b>Obtain IPv6 DNS Info Automatically</b> to have the Zyxel Device get the IPv6 DNS server addresses from the ISP automatically.
Use Following Static IPv6 DNS Address	Select <b>Use Following Static IPv6 DNS Address</b> to have the Zyxel Device use the IPv6 DNS server addresses you configure manually.
Primary DNS Server	Enter the first IPv6 DNS server address assigned by the ISP.
Secondary DNS Server	Enter the second IPv6 DNS server address assigned by the ISP.
IPv6 Routing Feature	
MLD Proxy Enable	Select this check box or option to have the Zyxel Device act as an MLD proxy on this connection. This allows the Zyxel Device to get subscription information and maintain a joined member list for each Multicast group. It can reduce Multicast traffic significantly.
Apply as Default Gateway	Select this option to have the Zyxel Device use the WAN interface of this connection as the system default gateway.

Table 24 Network Setting &gt; Broadband &gt; Add or Edit New WAN Interface (continued)

LABEL	DESCRIPTION
464XLAT	Enable this to have the Zyxel Device translate outgoing IPv4 packets to IPv6 packets. Use this function if you want to use IPv4 devices and services when your ISP provides an IPv6-only mobile network. See <a href="#">Section on page 118</a> for more information about 464XLAT.
Auto Prefix64	Enable this to have the Zyxel Device automatically add the IPv6 prefix assigned by your ISP to the outgoing IPv4 packets. Disable this and configure the <b>Static IPv6 Prefix</b> field if you want to manually assign an IPv6 prefix.
Static IPv6 Prefix	Enter an IPv6 prefix that the Zyxel Device adds to the outgoing IPv4 packets.
Cancel	Click <b>Cancel</b> to exit this screen without saving.
Apply	Click <b>Apply</b> to save your changes.

## 7.3 WAN Backup

Use this screen to configure your Zyxel Device's Internet settings if the wired connection is down. You can use an alternative network, and assign an IP address to verify the accessibility of the Internet and the time interval allowed between each connection check.

Click **Network Setting > Broadband > WAN Backup** to display the following screen.

Note: This feature is only available if **Ethernet WAN > State** is enabled.

Figure 72 Network Setting &gt; Broadband &gt; WAN Backup

The screenshot shows the 'Broadband' configuration page with the 'WAN Backup' tab selected. The page title is 'Broadband' and the sub-tab is 'WAN Backup'. Below the title, there are navigation tabs for 'Broadband', 'WAN Backup', 'Ethernet WAN', 'Cellular WAN', 'Cellular SIM', 'Cellular Band', and 'Cellular PLMN'. A message box states: 'Whenever the WAN connection is down, WAN Backup takes over the job and keeps you online.' The configuration options are as follows:

- WAN Backup Enable:** A toggle switch is turned on (blue).
- Primary WAN:** A dropdown menu is set to 'Ethernet'.
- The Destination for Connection Check:** A dropdown menu is set to 'Google DNS' and a text input field contains '8.8.8.8'.
- Connection Check Interval:** A text input field contains '60' with a range indicator '(30-600 secs)'.
- Check Fail Limit:** A text input field contains '3' with a range indicator '(1-10 times)'.

At the bottom of the screen, there are two buttons: 'Cancel' and 'Apply'.

The following table describes the fields in this screen.

Table 25 Network Setting > Broadband > WAN Backup

LABEL	DESCRIPTION
WAN Backup Enable	Select <b>Enable</b> to have the Zyxel Device use the cellular connection as your WAN or a backup when the wired WAN connection fails.
Primary WAN	This field displays the connection the Zyxel Device would use first when the wired WAN connection fails. You can choose <b>Ethernet</b> or <b>Cellular</b> as the primary WAN connection for your Zyxel Device.
The Destination for Connection Check	Configure this field to test your Zyxel Device's WAN accessibility. Enter the IP address of a reliable nearby computer (for example, your ISP's DNS server address).  Note: If you activate either traffic redirect or dial backup, you must configure at least one IP address here. When using a WAN backup connection, the Zyxel Device periodically pings the addresses configured here and uses the other WAN backup connection (if configured) if there is no response.
Connection Check Interval	When the Zyxel Device is using a lower priority connection (usually a WAN backup connection), it periodically checks to whether or not it can use a higher priority connection. Enter the number of seconds (30 recommended) for the Zyxel Device to wait between checks. Allow more time if your destination IP address handles lots of traffic.
Check Fail Limit	Enter the number of times that your Zyxel Device will ping the IP addresses configured in the <b>Destination for Connection Check</b> field without getting a response before switching to a WAN backup connection (or a different WAN backup connection).
Cancel	Click <b>Cancel</b> to exit this screen without saving.
Apply	Click <b>Apply</b> to save your changes.

## 7.4 Ethernet WAN

Use this screen to have a LAN port act as an Ethernet WAN port. When the switch goes to the right, the LAN port acts as an Ethernet WAN port. Otherwise, the LAN port remains as a LAN port. Click **Apply** to save your changes back to the Zyxel Device.

Click **Network Setting > Broadband > Ethernet WAN** to display the following screen.

Figure 73 Network Setting &gt; Broadband &gt; Ethernet WAN

**Broadband**

Broadband **Ethernet WAN** Cellular WAN Cellular SIM Cellular Band Cellular PLMN

You can convert Ethernet LAN port 4 to Ethernet WAN port or restore the WAN port to LAN port.

State:

Note

(1) Active Enable, the Ethernet Port is WAN Ethernet.  
 (2) Active Disable, the Ethernet Port is LAN Ethernet.  
 (3) If Ethernet WAN cable and Cellular interface is connected at the same time, only Ethernet WAN will link up.

Cancel **Apply**

## 7.5 Cellular WAN

Click **Network Setting > Broadband > Cellular WAN** to display the following screen. Use this screen to enable data roaming and network monitoring when the Zyxel Device cannot ping a base station.

Note: Roaming charges may apply when **Data Roaming** is enabled.

Figure 74 Network Setting &gt; Broadband &gt; Cellular WAN

**Broadband**

Broadband **Cellular WAN** Cellular APN Cellular SIM Cellular Band Cellular PLMN Cellular IP Passthrough Cellular SMS

Configure an LTE connection, including the Access Point Name (APN) provided by your service provider.

**Antenna**

Antenna Select

Note

LTE antenna select External/Internal.

**Roaming**

Data Roaming

Note

Roaming charges may apply when **Data Roaming** is enabled.

Cancel **Apply**

The following table describes the fields in this screen.

Table 26 Network Setting > Broadband > Cellular WAN

LABEL	DESCRIPTION
Antenna	
Antenna Select	Select between <b>External</b> or <b>Internal</b> Antenna for your Zyxel Device.
Data Roaming	Click this to enable data roaming on the Zyxel Device.  With cellular roaming, a SIM card works in areas which are not covered by the SIM's service provider. Enable roaming to keep the Zyxel Device connected to the Internet when you are traveling outside the geographical coverage area of the network to which you are registered, such as a different country.  Note: Roaming charges may apply when Data Roaming is enabled.
Apply	Click this to save your changes.
Cancel	Click this to exit this screen without saving.

## 7.6 Cellular APN

Click **Network Setting > Broadband > Cellular APN** to display the following screen. Use this screen to manage the APNs that Zyxel Device is connected to.

Note: This feature is only available on certain models. For details, see the features comparison table at [Section 1.1 on page 17](#).

Figure 75 Network Setting > Broadband > Cellular APN

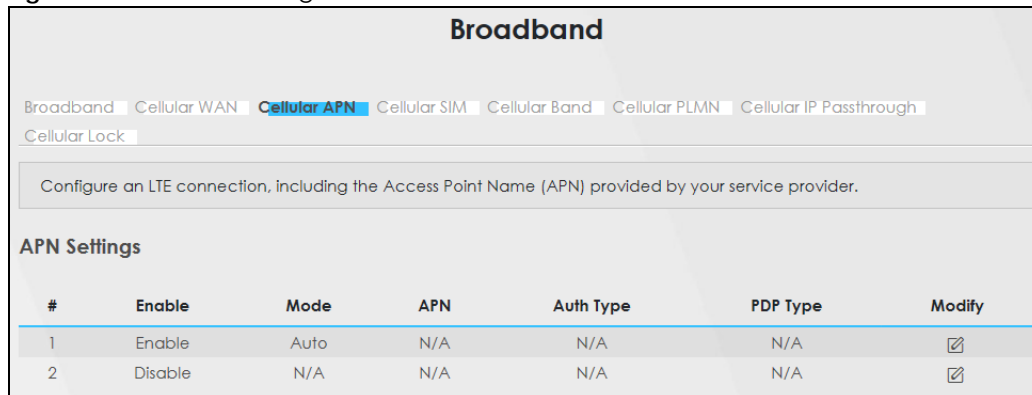

#	Enable	Mode	APN	Auth Type	PDP Type	Modify
1	Enable	Auto	N/A	N/A	N/A	
2	Disable	N/A	N/A	N/A	N/A	

The following table describes the labels in this screen.

Table 27 Network Setting > Broadband > Cellular APN

LABEL	DESCRIPTION
APN Settings	
#	This is the number of an individual APN.
Enable	This field indicates whether the APN is enabled or disabled.
Mode	This shows <b>Auto</b> when the Zyxel Device configures the APN (Access Point Name) of a cellular network automatically.  This shows <b>Manual</b> when the APN is entered manually.

Table 27 Network Setting &gt; Broadband &gt; Cellular APN

LABEL	DESCRIPTION
APN	This shows the Access Point Name (APN).
Auth Type	This shows <b>PAP</b> (Password Authentication Protocol) when peers identify themselves with a user name and password.  This shows <b>CHAP</b> (Challenge Handshake Authentication Protocol) when additionally to a user name and password, the Zyxel Device sends regular challenges to make sure an intruder has not replaced a peer.  This shows <b>PAP/CHAP</b> when either type of authentication can be used.  This shows <b>None</b> when no authentication is used.
PDP Type	This shows <b>IPv4</b> when the Zyxel Device runs IPv4 (Internet Protocol version 4 addressing system) only.  This shows <b>IPv4/IPv6</b> when the Zyxel Device runs IPv4 and IPv6 (Internet Protocol version 4 and 6 addressing system) at the same time.
Modify	Click the <b>Edit</b> icon to change the APN settings.

## 7.6.1 Edit Cellular APN1/APN2

On the **Cellular APN** screen, click the **Edit** icon next to an APN to configure its settings.

Note: APN information can be obtained from your cellular service provider.

Note: Automatic mode is not supported in all cellular modes.

**Figure 76** Network Setting > Broadband > Cellular APN > Edit APN 1

< Edit APN 1

Configure Access Point Name (APN) provided by your service provider.

Enable

APN Manual Mode

APN

Username  (Optional)

Password   (Optional)

Authentication Type

PDP Type

Note

(1) APN information can be obtained from the service provider.

(2) **Automatic APN Mode** is not supported when operating in 3G only mode.

Cancel OK



**Figure 77** Network Setting > Broadband > Cellular APN > Edit APN 2

The following table describes the fields in this screen.

**Table 28** Network Setting > Broadband > Cellular APN > Edit APN

LABEL	DESCRIPTION
Enable	Click this switch to enable the Access Point Name (APN) on the Zyxel Device.
APN Manual Mode	Disable this switch to have the Zyxel Device configure the APN of a cellular network automatically. Otherwise, Click this switch to enable and enter the APN manually in the field below.
APN	This field allows you to display the APN in the profile. Enter the APN provided by your service provider. Connections with different APNs may provide different services (such as Internet access or MMS (Multi-Media Messaging Service)) and charging method. You can enter up to 64 printable ASCII characters. Spaces are allowed.
Username	Enter the user name. You can enter up to 64 printable ASCII characters. Spaces are allowed.
Password	Enter the password associated with the user name above. You can enter up to 64 printable ASCII characters. Spaces are allowed.
Authentication Type	Select the type of authentication method peers use to connect to the Zyxel Device in cellular connections.  In Password Authentication Protocol ( <b>PAP</b> ) peers identify themselves with a user name and password. In Challenge Handshake Authentication Protocol ( <b>CHAP</b> ) additionally to user name and password the Zyxel Device sends regular challenges to make sure an intruder has not replaced a peer. Otherwise select <b>PAP/CHAP</b> or <b>None</b> .

Table 28 Network Setting &gt; Broadband &gt; Cellular APN &gt; Edit APN

LABEL	DESCRIPTION
PDP Type	Select <b>IPv4</b> if you want the Zyxel Device to run IPv4 (Internet Protocol version 4 addressing system) only.  Select <b>IPv4/IPv6</b> if you want the Zyxel Device to run both IPv4 and IPv6 (Internet Protocol version 4 and 6 addressing system) at the same time.
OK	Click <b>OK</b> to save your changes.
Cancel	Click <b>Cancel</b> to return to the previous screen without saving.

## 7.6.2 Using Separate APNs for Data and Management Traffic

Multiple APN Access allows a cellular device to open data sessions with two or more APNs, and then send data through the APNs simultaneously. If your cellular service provider supports Multiple APN Access, the Zyxel Device can use this feature to segregate cellular traffic.

Follow the steps below to configure the Zyxel Device to use separate APNs for data and management traffic.

- 1 At **Network Setting > Broadband > Cellular APN**, ensure that the Zyxel Device is connected to two data-enabled APNs. If your cellular service provider supports this feature, the Zyxel Device will connect to two APNs automatically.

#	Enable	Mode	APN	Auth Type	PDP Type	Modify
1	Enable	Auto	N/A	N/A	N/A	
2	Enable	Auto	N/A	N/A	N/A	

- 2 Go to **Maintenance > Remote Management > MGMT Services**. Set **WAN Interface used for services** to **Multi\_WAN**, and then select **Cellular WAN 2**.

### Remote Management

**MGMT Services** Trust Domain MGMT Services for IP PassThrough Trust Domain for IP PassThrough

Remote MGMT enables various approaches to access this device remotely from a WAN and/or LAN connection.

**Service Control**

WAN Interface used for services  Any\_WAN  Multi\_WAN

Cellular WAN 1  Cellular WAN 2  ETHWAN

Service	LAN/WLAN	WAN	Trust Domain	Port
HTTP	<input checked="" type="checkbox"/> Enable	<input type="checkbox"/> Enable	<input type="checkbox"/> Enable	80
HTTPS	<input checked="" type="checkbox"/> Enable	<input type="checkbox"/> Enable	<input type="checkbox"/> Enable	443
TELNET	<input checked="" type="checkbox"/> Enable	<input type="checkbox"/> Enable	<input type="checkbox"/> Enable	23
SSH	<input checked="" type="checkbox"/> Enable	<input type="checkbox"/> Enable	<input type="checkbox"/> Enable	22
PING	<input checked="" type="checkbox"/> Enable	<input type="checkbox"/> Enable	<input type="checkbox"/> Enable	

- 3 Go to **Maintenance > TR-069 Client**. Set WAN Interface used by TR-069 Client to **Multi\_WAN**, and then select **Cellular WAN 2**.

### TR-069 Client

TR-069 is a remote management tool on this device. The operator can upgrade firmware, modify settings, and diagnose problems remotely when TR-069 is enabled.

CWMP Active

Inform

Inform Interval

IP Protocol  TR069 on IPv4 Only  TR069 on IPv6 Only  Auto Select

ACS URL  (URL or IPv4 Address / Global IPv6 Address)

ACS User Name

ACS Password

WAN Interface Used by TR-069 Client  Any\_WAN  Multi\_WAN

Cellular WAN 1  Cellular WAN 2  ETHWAN

## 7.7 Cellular SIM Configuration

Use this screen to enter a PIN for your SIM card, in order to prevent others from using it.

**Entering the wrong PIN code 3 consecutive times locks the SIM card, after which you need a PUK (Personal Unlocking Key) from the service provider to unlock it.**

Click **Network Setting > Broadband > Cellular SIM**. The following screen opens.

**Figure 78** Network Setting > Broadband > Cellular SIM

**Broadband**

Broadband | Ethernet WAN | Cellular WAN | Cellular APN | **Cellular SIM** | Cellular Band | Cellular PLMN

Cellular IP Passthrough | Cellular SMS

Enter a PIN for your SIM card to prevent others from using it.

**PIN Management**

PIN Protection

Auto Unlock PIN

PIN

Attempts remaining: 3

Note

(1) The PIN is automatically saved in the Zyxel Device.  
 (2) Entering the wrong PIN exceeding a set number of times will lock the SIM card.

Cancel **Apply**

Note: The PIN is automatically saved in the Zyxel Device.  
 Entering the wrong PIN exceeding a set number of times will lock the SIM card.

The following table describes the fields in this screen.

**Table 29** Network Setting > Broadband > Cellular SIM

LABEL	DESCRIPTION
PIN Management	
PIN Protection	A PIN (Personal Identification Number) code is a key to a SIM card. Without the PIN code, you cannot use the SIM card.  Click this switch to enable if the service provider requires you to enter a PIN to use the SIM card.  Click this switch to disable if the service provider lets you use the SIM without inputting a PIN.
Auto Unlock PIN	If <b>PIN Protection</b> is enabled, the SIM card requires a PIN code to unlock the PIN lock.  Slide the switch to the right to have the Zyxel Device automatically unlock the PIN lock.  Otherwise, slide the switch to the left. You will need to manually enter the PIN every time you reboot the Zyxel Device or reinsert the SIM card to use the SIM card.
PIN	If you enabled PIN verification, enter the 4-digit PIN code (0000 for example) provided by your ISP. If you enter the PIN code incorrectly too many times, the ISP may block your SIM card and not let you use the account to access the Internet.
Attempts Remaining	This is how many more times you can try to enter the PIN code before the ISP blocks your SIM card. If your ISP locks your SIM card, you will need to request a PUK code from them to unlock it.
Apply	Click <b>Apply</b> to save your changes.
Cancel	Click <b>Cancel</b> to return to the previous screen without saving.

## 7.8 Cellular Band Configuration

Either select **Auto Switch** to have the Zyxel Device connect to an available network using the default settings on the SIM card or select the type of the network (**4G**, **NR5G-NSA**, or **NR5G-SA**) to which you want the Zyxel Device to connect.

Click **Network Setting > Broadband > Cellular Band**. The following screen opens.

**Figure 79** Network Setting > Broadband > Cellular Band

The following table describes the fields in this screen.

**Table 30** Network Setting > Broadband > Cellular Band

LABEL	DESCRIPTION
Access Technology	
Preferred Access Technology	Select the cellular mode your Zyxel Device supports to which you want the Zyxel Device to connect, and then click <b>Apply</b> to save your settings.  Otherwise, select <b>Auto Switch</b> to have the Zyxel Device connect to an available network using the default settings on the SIM card. If the currently registered mobile network is not available or the mobile network's signal strength is too low, the Zyxel Device switches to another available mobile network.
Band Management	
Band Auto Selection	Select the cellular bands to use for the Zyxel Device's cellular WAN connection. Click this switch to enable automatic frequency band selection as provided by the cellular service provider. Otherwise, select disabled.
Apply	Click this to save your changes.
Cancel	Click this to exit this screen without saving.

## 7.9 Cellular PLMN Configuration

Each service provider has its own unique Public Land Mobile Network (PLMN) number. Either select **PLMN Auto Selection** to have the Zyxel Device connect to the service provider using the default settings on the SIM card, or manually view available PLMNs and select your service provider.

Click **Network Setting > Broadband > Cellular PLMN**. The screen appears as shown next.

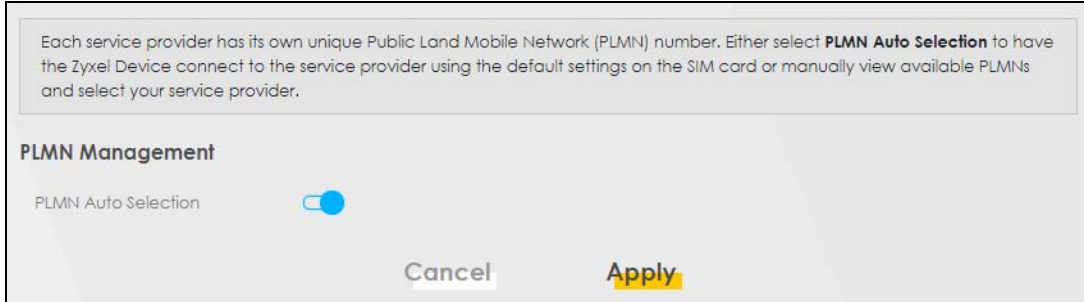
**Figure 80** Network Setting > Broadband > Cellular PLMN

The following table describes the labels in this screen.

**Table 31** Network Setting > Broadband > Cellular PLMN

LABEL	DESCRIPTION
PLMN Management	
PLMN Auto Selection	Click this switch to enable and have the Zyxel Device automatically connect to the first available mobile network. Select disabled to display the network list and manually select a preferred network.
Apply	Click <b>Apply</b> to save your changes back to the Zyxel Device.
Cancel	Click <b>Cancel</b> to exit this screen without saving.

After selecting to disable the following warning appears. Click **OK** to continue.

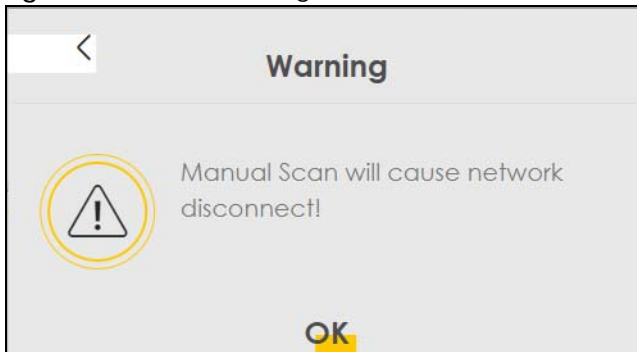
**Figure 81** Network Setting > Broadband > Cellular PLMN > Manual Scan Warning

Click **Scan** to check for available PLMNs in the area surrounding the Zyxel Device, and then display them in the network list. Select from the network list and click **Apply**.

Figure 82 Network Setting &gt; Broadband &gt; Cellular PLMN &gt; Manual Scan

Cellular PLMN Configuration

**PLMN Management**

PLMN Auto Selection

**Scan**

#	Status	Name	Type	PLMN
<input type="radio"/>	Available	FET	LTE	46601
<input type="radio"/>	Current	FET	UMTS	46601
<input type="radio"/>	Forbidden	TWM	UMTS	46697
<input type="radio"/>	Available	Chunghwa	UMTS	46692
<input type="radio"/>	Available	Chunghwa	LTE	46692
<input type="radio"/>	Forbidden	T Star	LTE	46689
<input type="radio"/>	Forbidden	TWM	LTE	46697
<input type="radio"/>	Forbidden	466 05	GPRS	46605
<input type="radio"/>	Forbidden	466 05	LTE	46605
<input type="radio"/>	Forbidden	T Star	UMTS	46689

**Cancel** **Apply**

The following table describes the labels in this screen.

Table 32 Network Setting &gt; Broadband &gt; Cellular PLMN &gt; Manual Scan

LABEL	DESCRIPTION
#	Select the ISP that you want the Zyxel Device connects to.
Status	This shows <b>Current</b> to show the ISP the Zyxel Device is currently connected to. This shows <b>Forbidden</b> to indicate the Zyxel Device cannot connect to this ISP. This shows <b>Available</b> to indicate an available ISP your Zyxel Device can connect to.
Name	This shows the ISP name.
Type	This shows the type of network the ISP provides.
PLMN	This shows the PLMN number.
Apply	Click <b>Apply</b> to save your changes back to the Zyxel Device.
Cancel	Click <b>Cancel</b> to exit this screen without saving.

## 7.10 Cellular IP Passthrough

Enable **IP Passthrough** to allow Internet traffic to go to a LAN computer behind the Zyxel Device without going through NAT.

Click **Network Setting > Broadband > Cellular IP Passthrough** to display the following screen.

Note: This screen is not available when the fourth LAN port acts as an Ethernet WAN port.

Note: This screen is not available if Ethernet WAN is enabled at **Network Setting > Broadband > Ethernet WAN > State**.

**Figure 83** Network Setting > Broadband > Cellular IP Passthrough

Enable **IP Passthrough** to allow internet traffic to go to a LAN computer behind the Zyxel Device without going through NAT.

**IP Passthrough Management**

IP Passthrough

Passthrough Mode Fixed

Passthrough to fixed MAC

Note  
Changing the **IP Passthrough** settings may affect the network setting of client devices.

Cancel Apply

Note: Changing the **IP Passthrough** settings may affect the network setting of client devices. After selecting to enable the following warning appears. Click **OK** to continue.

**Figure 84** Network Setting > Broadband > Cellular IP Passthrough > Enable Warning

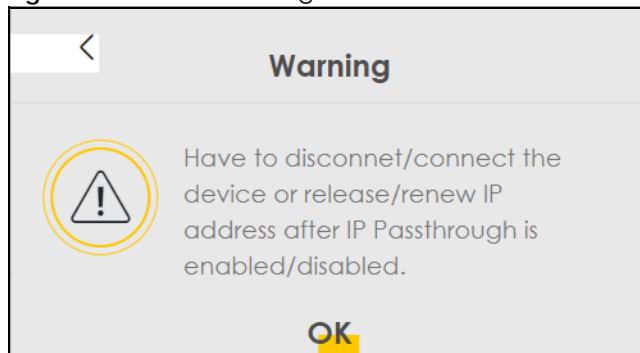

The following table describes the fields in this screen.

Table 33 Network Setting > Broadband > Cellular IP Passthrough

LABEL	DESCRIPTION
IP Passthrough Management	
IP Passthrough	IP Passthrough allows a LAN computer on the local network of the Zyxel Device to have access to web services using the public IP address. When IP Passthrough is configured, all traffic is forwarded to the LAN computer and will not go through NAT.



Table 33 Network Setting &gt; Broadband &gt; Cellular IP Passthrough (continued)

LABEL	DESCRIPTION
Passthrough Mode	Select <b>Dynamic</b> to allow traffic to be forwarded to the first LAN computer on the local network of the Zyxel Device. Select <b>Fixed</b> to allow traffic to be forwarded to a specific computer (for example, Client A) by entering its MAC address.  Note: This field will show after enabling <b>IP Passthrough</b> in the previous field.
Passthrough to fixed MAC	Enter the MAC address of a LAN computer on the local network of the Zyxel Device upon selecting <b>Fixed</b> in the previous field.  Note: This field will show after selecting <b>Fixed</b> in the previous field.
Apply	Click this to save your changes.
Cancel	Click this to exit this screen without saving.

## 7.11 Cellular SMS

Use this screen to send and receive SMS messages using the SIM card installed in the Zyxel Device.

Click **Network Setting > Broadband > Cellular SMS**. The following screen displays.

Figure 85 Network Setting &gt; Broadband &gt; Cellular SMS

**Broadband**

Broadband | Ethernet WAN | Cellular WAN | Cellular APN | Cellular SIM | Cellular Band | Cellular PLMN | Cellular IP Passthrough | **Cellular SMS**

Cellular SMS Configuration

+ Add New Message

**Storage Status**

Used Capacity                      0

Total Capacity                    100

**SMS Inbox**

**Retrieve Messages**

#	From	Time Stamp	Content	Modify
---	------	------------	---------	--------

**SMS Outbox**

#	To	Time Stamp	Content	Modify
---	----	------------	---------	--------

**Delete All Messages**

Note

(1) Used Capacity is not represented the counts of message number one on one, cause of message concatenated.

(2) Once the Used Capacity is reached up the Total Capacity, the new SMS message may not received any more until the old one is deleted.

The following table describes the fields in this screen.

Table 34 Network Setting &gt; Broadband &gt; Cellular SMS

LABEL	DESCRIPTION
Add New Message	Click this to open the Send New Message screen and send an SMS message from the Zyxel Device.
Storage Status	
Used Capacity	This displays the used storage capacity of the Zyxel Device to receive SMS messages.  Note: The Zyxel Device will stop receiving SMS messages when <b>Used Capacity</b> is the same as <b>Total Capacity</b> . To continue receiving SMS messages, delete old message(s) by clicking the delete icon in <b>Modify</b> , or click <b>Delete All Messages</b> .
Total Capacity	This displays <b>100</b> . This is the maximum capacity to receive SMS messages on the Zyxel Device.
SMS Inbox	
Retrieve Messages	Click this to receive SMS messages.

Table 34 Network Setting &gt; Broadband &gt; Cellular SMS (continued)

LABEL	DESCRIPTION
#	This displays the index number of the received message.
From	This displays the phone number that sent the message.
Time Stamp	This displays the time and date that the Zyxel Device received the message.
Content	This displays the content of the message.
Modify	This allows you to delete the message.
SMS Outbox	
#	This displays the index number of the SMS message sent.
To	This displays the recipient's phone number that will get the SMS message.
Time Stamp	This displays the time and date that the Zyxel Device send the SMS message.
Content	This displays the content of the SMS message.
Modify	This allows you to delete the SMS message.
Delete All Messages	Click this to remove all SMS messages on the Zyxel Device.

### 7.11.1 Send New Message Screen

Use this screen to send an SMS message from the Zyxel Device. Go to **Network Setting > Broadband > Cellular SMS** and click Add New Message to view this screen.

Figure 86 Network Setting &gt; Broadband &gt; Cellular SMS: Send New Message

The screenshot shows the 'Send New Message' interface. At the top left is a back arrow. The title 'Send New Message' is centered. Below it are the following fields:

- Character Set:** A dropdown menu currently showing 'GSM default alphabet'.
- Mobile Number:** An empty text input field.
- Text Message:** A large text area for composing the message, with a '140' character limit indicator on the right side.
- Non-GSM Character:** A checkbox that is currently unchecked.

At the bottom, there is a 'Note' section with two lines of text:

- (1) The character limit for a single SMS message is 140 by using GSM-7 encoding.
- (2) The character limit for a single SMS message is 70 by using Unicode encoding.

At the bottom right, there are two buttons: 'Cancel' and 'OK'.

The following table describes the fields in this screen.

Table 35 Network Setting > Broadband > Cellular SMS: Send New Message

LABEL	DESCRIPTION
Character Set	Select whether you want to send the SMS message using GSM-7 encoding or unicode. <ul style="list-style-type: none"><li>• <b>GSM default alphabet:</b> Use standard ASCII numbers, letters, and special characters. The maximum length of the message is 140 characters.</li><li>• <b>Unicode alphabet:</b> Use any non-English Unicode characters. The maximum length of the message is 70 characters.</li></ul>
Mobile Number	Specify the cellphone number that you want to send the message to.
Text Message	Specify the content of the message.
OK	Click this button to send the message.
Cancel	Click this button to close the window without sending the message.

# CHAPTER 8

## Wireless

### 8.1 Wireless Overview

This chapter describes the Zyxel Device's **Network Setting > Wireless** screens. Use these screens to set up your Zyxel Device's WiFi network and security settings.

#### 8.1.1 What You Can Do in this Chapter

This section describes the Zyxel Device's **Wireless** screens. Use these screens to set up your Zyxel Device's WiFi connection.

- Use the **General** screen to enable the Wireless LAN, enter the SSID and select the WiFi security mode ([Section 8.2 on page 142](#)).
- Use the **Guest/More AP** screen to set up multiple WiFi networks on your Zyxel Device ([Section 8.3 on page 147](#)).
- Use the **MAC Authentication** screen to allow or deny WiFi clients based on their MAC addresses from connecting to the Zyxel Device ([Section 8.4 on page 149](#)).
- Use the **WPS** screen to enable or disable WPS, view or generate a security PIN (Personal Identification Number) ([Section 8.5 on page 151](#)).
- Use the **WMM** screen to enable WiFi MultiMedia (WMM) to ensure quality of service in WiFi networks for multimedia applications ([Section 8.6 on page 153](#)).
- Use the **Others** screen to configure WiFi advanced features, such as the RTS/CTS Threshold ([Section 8.7 on page 154](#)).
- Use the **Channel Status** screen to scan the number of accessing points and view the results ([Section 8.8 on page 156](#)).
- Use the **WLAN Scheduler** screen to create rules to schedule the times to permit Internet traffic from each wireless network interfaces ([Section 8.9 on page 158](#)).
- Use the **EasyMesh** screen to enable to disable Easy Mesh Controller on your Zyxel Device ([Section 8.10 on page 160](#)).

#### 8.1.2 What You Need to Know

##### Wireless Basics

"Wireless" is essentially radio communication. In the same way that walkie-talkie radios send and receive information over the airwaves, wireless networking devices exchange information with one another. A wireless networking device is just like a radio that lets your computer exchange information with radios attached to other computers. Like walkie-talkies, most wireless networking devices operate at radio frequency bands that are open to the public and do not require a license to use. However, wireless networking is different from that of most traditional radio communications in that there are a number of wireless networking standards available with different methods of data encryption.

## Finding Out More

See [Section 8.11 on page 161](#) for advanced technical information on WiFi networks.

## 8.2 Wireless General Settings

Use this screen to enable the WiFi, enter the SSID and select the WiFi security mode. We recommend that you select **More Secure** to enable **WPA3-SAE** data encryption.

Note: If you are configuring the Zyxel Device from a computer connected by WiFi and you change the Zyxel Device's SSID, channel or security settings, you will lose your WiFi connection when you press **Apply**. You must change the WiFi settings of your computer to match the new settings on the Zyxel Device.

Click **Network Setting** > **Wireless** to open the **General** screen.

Figure 87 Network Setting &gt; Wireless &gt; General

A network name (also known as SSID) and a security level are basic elements of a network. Set a **Security Level** to protect your data from unauthorized access or damage via WiFi. It's recommended that you select **More Secure** to enable **WPA2-PSK** data encryption.

### WiFi

WiFi  Keep the same settings for 2.4G and 5G WiFi networks

### WiFi Network Setup

Band: 2.4GHz

WiFi:

Channel: Auto Current : 11 / 20 MHz

Bandwidth: 20/40MHz

Control Sideband: Lower

### WiFi Network Settings

WiFi Network Name: Zyxel\_2830

Max Clients: 32

Hide SSID i

Multicast Forwarding

BSSID: D8:EC:E5:34:28:20

### Security Level

No Security
More Secure (Recommended)

Security Mode: WPA2-PSK

Generate password automatically

Enter 8-63 ASCII characters or 64 hexadecimal digits ("0-9", "A-F").

Password:  👁

Strength:  strong

i

Cancel
Apply

The following table describes the general WiFi labels in this screen.

Table 36 Network Setting > Wireless > General

LABEL	DESCRIPTION
Wireless	
WiFi	Select <b>Keep the same settings for 2.4G and 5G WiFi networks</b> and the 2.4 GHz / 5 GHz WiFi networks will use the same SSID and WiFi security settings.
MLO	<p>Select <b>MLO</b> to allow a WiFi 7 client to connect to the AP using multiple frequency bands simultaneously. This increases speed and improves reliability of the WiFi connection. MLO makes WiFi 7 ideal for streaming 4K / 8K videos, using augmented reality (AR), virtual reality (VR) applications and playing online games.</p> <p>Note: To enable MLO, select <b>Keep the same settings for 2.4G, 5G and 6G wireless networks</b>.</p> <p>Note: To use MLO, both the AP and the WiFi client have to support MLO.</p>
Wireless/WiFi Network Setup	
Band	This shows the WiFi band which this radio profile is using. <b>2.4GHz</b> is the frequency used by IEEE 802.11b/g/n/ax WiFi clients, <b>5GHz</b> is used by IEEE 802.11a/n/ac/ax WiFi clients.
Wireless/WiFi	Click this switch to enable or disable WiFi in this field. When the switch turns blue, the function is enabled. Otherwise, it is not.
Channel	<p>Select a channel from the drop-down list box. The options vary depending on the frequency band and the country you are in.</p> <p>Use <b>Auto</b> to have the Zyxel Device automatically determine a channel to use.</p>
Bandwidth	<p>A standard 20 MHz channel offers transfer speeds of up to 150 Mbps whereas a 40 MHz channel uses two standard channels and offers speeds of up to 300 Mbps.</p> <p>40 MHz (channel bonding or dual channel) bonds two adjacent radio channels to increase throughput. The WiFi clients must also support 40 MHz. It is often better to use the 20 MHz setting in a location where the environment hinders the WiFi signal.</p> <p>An 80 MHz channel groups adjacent 40 MHz channels into pairs to increase bandwidth even higher.</p> <p>Select <b>20MHz</b> if you want to lessen radio interference with other wireless devices in your neighborhood or the WiFi clients do not support channel bonding.</p> <p>Not all Zyxel Devices support all channels. The Zyxel Device will choose the best bandwidth available automatically depending on the radio you chose and network conditions.</p>
Control Sideband	This is available for some regions when you select a specific channel and set the <b>Bandwidth</b> field to <b>40MHz</b> or <b>20/40MHz</b> . Set whether the control channel (set in the <b>Channel</b> field) should be in the <b>Lower</b> or <b>Upper</b> range of channel bands.
Wireless/WiFi Network Settings	
Wireless/WiFi Network Name	<p>The SSID (Service Set IDentity) identifies the service set with which a wireless device is associated. Wireless devices associating to the access point (AP) must have the same SSID.</p> <p>Enter a descriptive name for this WiFi network. You can use up to 32 printable characters, including spaces.</p>
Max Clients	Specify the maximum number of clients that can connect to this network at the same time.
Hide SSID	<p>Select this checkbox to hide the SSID in the outgoing beacon frame so a station cannot obtain the SSID through scanning using a site survey tool.</p> <p>This checkbox is grayed out if the WPS function is enabled in the <b>Network Setting &gt; Wireless &gt; WPS</b> screen.</p>
Multicast Forwarding	Select this checkbox to allow the Zyxel Device to convert wireless Multicast traffic into wireless unicast traffic.



Table 36 Network Setting &gt; Wireless &gt; General (continued)

LABEL	DESCRIPTION
Max. Upstream Bandwidth	Max. Upstream Bandwidth allows you to specify the maximum rate for upstream wireless traffic to the WAN from this wireless LAN in kilobits per second (Kbps).
Max. Downstream Bandwidth	Max. Upstream Bandwidth allows you to specify the maximum rate for downstream wireless traffic to this wireless LAN from the WAN in kilobits per second (Kbps).
BSSID	This shows the MAC address of the wireless interface on the Zyxel Device when WiFi is enabled.
Security Level	
Security Mode	Select <b>More Secure (Recommended)</b> to add security on this WiFi network. The WiFi clients which want to associate to this network must have same WiFi security settings as the Zyxel Device. When you select to use a security, additional options appears in this screen.  Or you can select <b>No Security</b> to allow any client to associate this network without any data encryption or authentication.  See the following sections for more details about this field.
Cancel	Click <b>Cancel</b> to restore your previously saved settings.
Apply	Click <b>Apply</b> to save your changes.

## 8.2.1 No Security

Select **No Security** to allow wireless stations to communicate with the access points without any data encryption or authentication.

Note: If you do not enable any WiFi security on your Zyxel Device, your network is accessible to any wireless networking device that is within range.

Figure 88 Wireless &gt; General: No Security

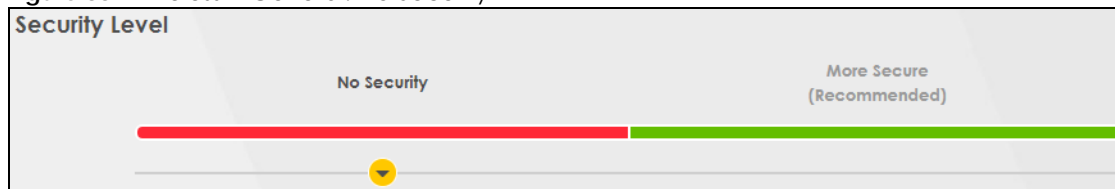

The following table describes the labels in this screen.

Table 37 Wireless &gt; General: No Security

LABEL	DESCRIPTION
Security Level	Choose <b>No Security</b> to allow all WiFi connections without data encryption or authentication.

## 8.2.2 More Secure (Recommended)

The WPA-PSK (WiFi Protected Access-Pre-Shared Key) security mode provides both improved data encryption and user authentication over WEP. Using a pre-shared key, both the Zyxel Device and the connecting client share a common password in order to validate the connection. This type of encryption, while robust, is not as strong as WPA, WPA2 or even WPA2-PSK. The WPA2-PSK security mode is a more robust version of the WPA encryption standard. It offers better security, although the use of PSK makes it less robust than it could be.

The WPA3-SAE (Simultaneous Authentication of Equals handshake) security mode protects against dictionary attacks (password guessing attempts). It improves security by requiring a new encryption key every time a WPA3 connection is made. A handshake is the communication between the Zyxel Device and a connecting client at the beginning of a WiFi session.

Click **Network Setting > Wireless** to display the **General** screen. Select **More Secure** as the security level. Then select **WPA3-SAE** from the **Security Mode** list if your WiFi client supports it. If you are not sure, select **WPA3-SAE/WPA2-PSK** or **WPA2-PSK**.



**Figure 89** Wireless > General: More Secure: WPA3-SAE/WPA2-PSK

The following table describes the labels in this screen.

**Table 38** Wireless > General: More Secure: WPA3-SAE/WPA2-PSK

LABEL	DESCRIPTION
Security Level	Select <b>More Secure</b> to enable data encryption.
Security Mode	Select a security mode from the drop-down list box.
Generate password automatically	Select this option to have the Zyxel Device automatically generate a password. The password field will not be configurable when you select this option.

Table 38 Wireless &gt; General: More Secure: WPA3-SAE/WPA2-PSK (continued)

LABEL	DESCRIPTION
Password	<p>Select <b>Generate password automatically</b> or enter a <b>Password</b>.</p> <p>The password has two uses.</p> <ol style="list-style-type: none"> <li>1. Manual. Manually enter the same password on the Zyxel Device and the client. You can use 8 – 63 alphanumeric (0-9, a-z, A-Z) and special characters, including spaces.</li> <li>2. WPS. When using WPS, the Zyxel Device sends this password to the client.</li> </ol> <p>Note: More than 63 hexadecimal characters are not accepted for WPS.</p> <p>Click the Eye icon to show or hide the password for your wireless network. When the Eye icon is slashed , you will see the password in plain text. Otherwise, it is hidden.</p>
Strength	This displays the current password strength – <b>weak, medium, strong</b> .
Click this  to show more fields in this section. Click this  to hide them.	
Encryption	<p><b>AES</b> is the default data encryption type, which uses a 128-bit key.</p> <p>Select the encryption type (<b>AES</b> or <b>TKIP+AES</b>) for data encryption.</p> <p>Select <b>AES</b> if your WiFi clients can all use AES.</p> <p>Select <b>TKIP+AES</b> to allow the WiFi clients to use either TKIP or AES.</p> <p>Note: Not all models support <b>TKIP+AES</b> encryption.</p>
Timer	This is the rate at which the RADIUS server sends a new group key out to all clients.

## 8.3 Guest/More AP Screen

Use this screen to configure a guest WiFi network that allows access to the Internet through the Zyxel Device. You can use one access point to provide several BSSs simultaneously. You can then assign varying security types to different SSIDs. WiFi clients can use different SSIDs to associate with the same access point.

Click **Network Setting > Wireless > Guest/More AP**.







The following table introduces the supported WiFi networks.

Table 39 Supported WiFi Networks

WIFI NETWORKS	WHERE TO CONFIGURE
Main/1	Network Setting > Wireless > General screen
Guest/3	Network Setting > Wireless > Guest/More AP screen

The following screen displays.

**Figure 90** Network Setting > Wireless > Guest/More AP

This device can enable up to 4 wireless networks to work at the same time. Assign a name and a security level (if needed) to start the 2nd, 3rd, and 4th wireless network services.					
#	Status	SSID	Security	Guest WLAN	Modify
1		Zyxel_9DE5_guest1	WPA2-Personal	External Guest	
2		Zyxel_9DE5_guest2	WPA2-Personal	External Guest	
3		Zyxel_9DE5_guest3	WPA2-Personal	External Guest	

The following table describes the labels in this screen.

**Table 40** Network Setting > Wireless > Guest/More AP

LABEL	DESCRIPTION
#	This is the index number of the entry.
Status	This field indicates whether this SSID is active. A yellow bulb signifies that this SSID is active, while a gray bulb signifies that this SSID is not active.
SSID	An SSID profile is the set of parameters relating to one of the Zyxel Device's BSSs. The SSID (Service Set Identifier) identifies the Service Set with which a wireless device is associated.  This field displays the name of the WiFi profile on the network. When a WiFi client scans for an AP to associate with, this is the name that is broadcast and seen in the WiFi client utility.
Security	This field indicates the security mode of the SSID profile.
Guest WLAN	This displays if the guest WLAN function has been enabled for this WLAN.  If <b>Home Guest</b> displays, clients can connect to each other directly.  If <b>External Guest</b> displays, clients are blocked from connecting to each other directly.  <b>N/A</b> displays if guest WLAN is disabled.
Modify	Click the <b>Edit</b> icon of an SSID profile to configure the SSID profile.

### 8.3.1 The Edit Guest/More AP Screen

Use this screen to create Guest and additional WiFi networks with different security settings.

Note: If upstream/downstream bandwidth is empty, the Zyxel Device sets the value automatically. Setting a maximum upstream/downstream bandwidth will significantly decrease WiFi performance.

Click the **Edit** icon next to an SSID in the **Guest/More AP** screen. The following screen displays.

Figure 91 Network Setting &gt; Wireless &gt; More AP &gt; Edit

The screenshot displays the 'More AP Edit' configuration interface. At the top, a warning message states: 'WiFi security can protect the data from unauthorized access or damage via WiFi network. You need a WiFi network name (also known as SSID) and security mode to set up the Wi-Fi security.'

**WiFi Network Setup**

- WiFi:
- Security Level:
  - WiFi Network Name: Zyxel\_577D\_guest1
  - Hide SSID
  - Guest WLAN
  - Access Scenario: External Guest
  - BSSID: 00:00:00:00:00:00
  - SSID Subnet:
  - DHCP Start Address: [ ]
  - DHCP End Address: [ ]
  - SSID Subnet Mask: [ ]
  - LAN IP Address: [ ]

**Security Level**

A progress bar indicates the security level, ranging from 'No Security' (red) to 'More Secure (Recommended)' (green). The current level is positioned towards the 'More Secure' end.

**Security Mode Configuration Panel:**

- Security Mode: WPA2-PSK
- Generate password automatically
- Enter 8-63 ASCII characters or 64 hexadecimal digits [0-9; "A-F"].
- Password: [ ]
- Strength: medium
- Encryption: AES
- Timer: 3600 sec

Buttons for 'Cancel' and 'OK' are located at the bottom of the screen.

## 8.4 MAC Authentication

Use this screen to give exclusive access to specific connected devices (**Allow**) or exclude specific devices from accessing the Zyxel Device (**Deny**), based on the MAC address of each connected device. Every Ethernet device has a unique factory-assigned MAC (Media Access Control) address, which consists of six pairs of hexadecimal characters, for example: 00:A0:C5:00:00:02. You need to know the MAC addresses of the connected device you want to allow/deny to configure this screen.

Note: You can have up to 25 MAC authentication rules.

Use this screen to view your Zyxel Device's MAC filter settings and add new MAC filter rules. Click **Network Setting > Wireless > MAC Authentication**. The screen appears as shown.

**Figure 92** Network Setting > Wireless > MAC Authentication

**WiFi**

General **MAC Authentication** WMM Others

Configure the Zyxel Device to give exclusive access to specific devices (**Allow**) or exclude specific devices from accessing the Zyxel Device (**Deny**) based on the device(s) MAC address. Every Ethernet device has a unique MAC (Media Access Control) address. It is assigned at the factory and consists of six pairs of hexadecimal characters; for example, 00:A0:C5:00:00:02. You need to know the MAC addresses of the device(s) you want to allow/deny to configure this screen. Edit the list in the table to decide the rule of access on device(s).

**General**

SSID

MAC Restrict Mode  Disable  Deny  Allow

**MAC address List** + Add new MAC address

#	MAC Address	Modify

Note  
A maximum of 25 MAC Authentication rules can be configured.

The following table describes the labels in this screen.

**Table 41** Network Setting > Wireless > MAC Authentication

LABEL	DESCRIPTION
General	
SSID	Select the SSID for which you want to configure MAC filter settings.
MAC Restrict Mode	Define the filter action for the list of MAC addresses in the <b>MAC Address</b> table. Select <b>Disable</b> to turn off MAC filtering. Select <b>Deny</b> to block access to the Zyxel Device. MAC addresses not listed will be allowed to access the Zyxel Device. Select <b>Allow</b> to permit access to the Zyxel Device. MAC addresses not listed will be denied access to the Zyxel Device.
MAC address List	

Table 41 Network Setting &gt; Wireless &gt; MAC Authentication (continued)

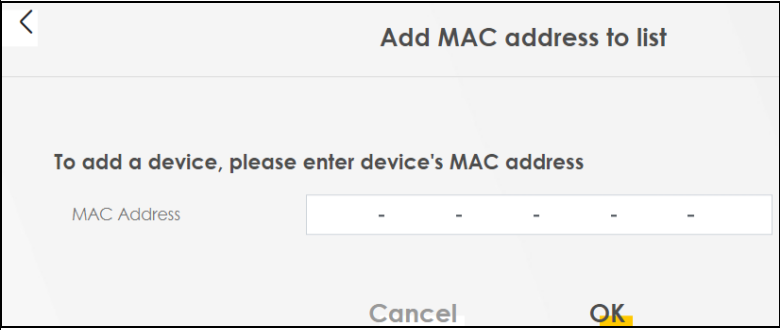
LABEL	DESCRIPTION
Add new MAC address	<p>This field is available when you select <b>Deny</b> or <b>Allow</b> in the <b>MAC Restrict Mode</b> field.</p> <p>Click this if you want to add a new MAC address entry to the MAC filter list below.</p> <p>Enter the MAC addresses of the WiFi devices that are allowed or denied access to the Zyxel Device in these address fields. Enter the MAC addresses in a valid MAC address format, that is, six hexadecimal character pairs, for example, 12:34:56:78:9a:bc.</p> 
#	This is the index number of the entry.
MAC Address	This is the MAC addresses of the WiFi devices that are allowed or denied access to the Zyxel Device.
Modify	<p>Click the <b>Edit</b> icon and type the MAC address of the peer device in a valid MAC address format (six hexadecimal character pairs, for example 12:34:56:78:9a:bc).</p> <p>Click the <b>Delete</b> icon to delete the entry.</p>
Cancel	Click <b>Cancel</b> to exit this screen without saving.
Apply	Click <b>Apply</b> to save your changes.

## 8.5 WPS

Use this screen to configure WiFi Protected Setup (WPS) on your Zyxel Device.

WiFi Protected Setup (WPS) allows you to quickly set up a WiFi network with strong security, without having to configure security settings manually. Select one of the WPS methods and follow the instructions to establish a WPS connection. Your WiFi devices must support WPS to use this feature. We recommend using Push Button Configuration (**PBC**) if your WiFi device supports it.

Note: The Zyxel Device applies the security settings of the main SSID (**SSID1**) profile to the WPS WiFi connection (see [Section 8.2.2 on page 145](#)).

Note: The Zyxel Device applies the security settings of the main SSID (**SSID1**) profile to the WPS wireless connection (see [Section 8.2.2 on page 145](#)). Some models support more than one SSID profile, check the supported number on the **Network Setting > Wireless > General** screen.

Note: The WPS switch is unavailable if the WiFi is disabled.  
If WPS is enabled, UPnP will automatically be turned on.

Click **Network Setting > Wireless > WPS**. The following screen displays. Click this switch and it will turn blue. Click **Apply** to activate the WPS function. Then you can configure the WPS settings in this screen.

Figure 93 Network Setting > Wireless > WPS

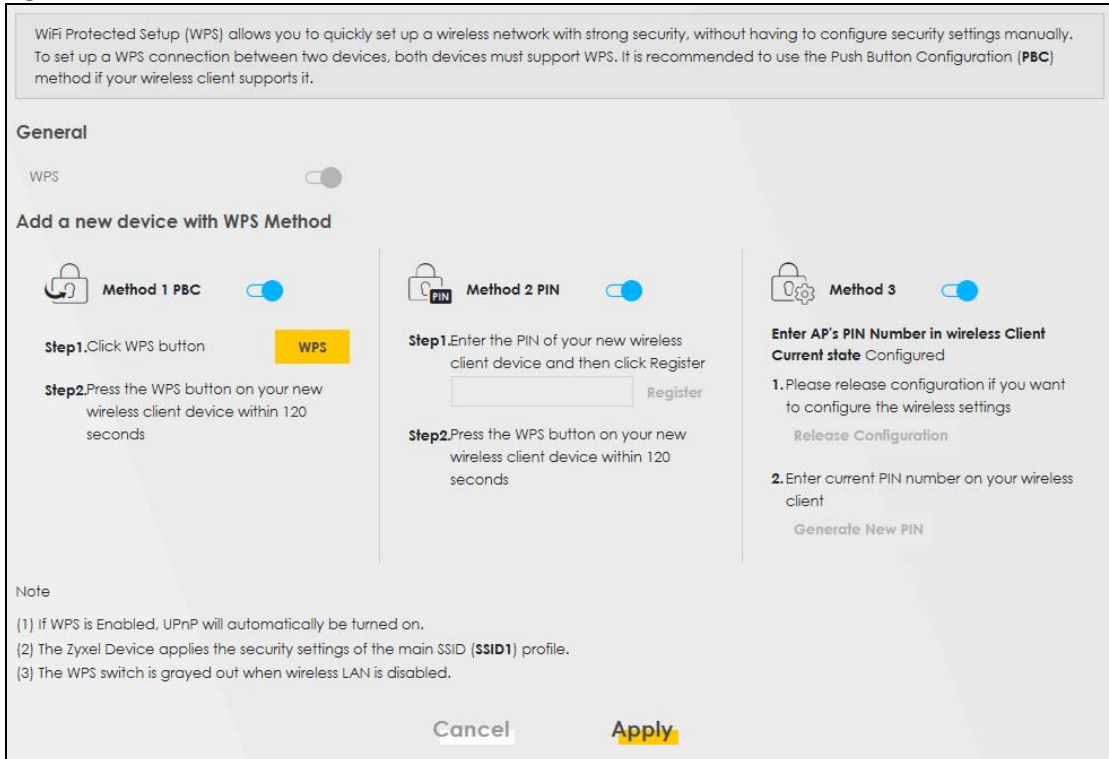
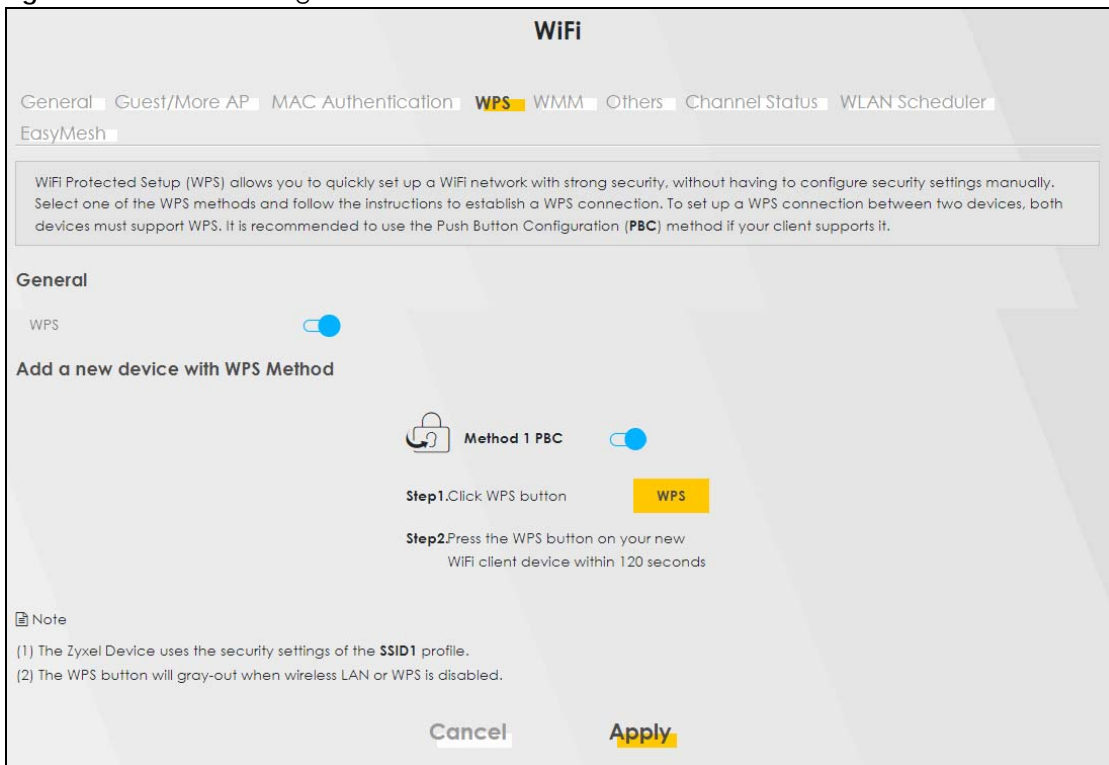

Figure 94 Network Setting > Wireless > WPS





The following table describes the labels in this screen.

Table 42 Network Setting > Wireless > WPS

LABEL	DESCRIPTION
General	
WPS	Slide this to the right to enable and have the Zyxel Device activate WPS. Otherwise, it is disabled.
Add a new device with WPS Method	
Method 1 PBC	Use this section to set up a WPS WiFi network using Push Button Configuration (PBC). Click this switch to make it turn blue. Click <b>Apply</b> to activate WPS method 1 on the Zyxel Device.
WPS	Click this button to add another WPS-enabled WiFi device (within WiFi range of the Zyxel Device) to your WiFi network. This button may either be a physical button on the outside of a WiFi device, or a menu button similar to the <b>WPS button</b> on this screen.  Note: You must press the other WiFi device's WPS button within 2 minutes of pressing this button.
Method 2 PIN	Use this section to set up a WPS WiFi network by entering the PIN of the client into the Zyxel Device. Click this switch to make it turn blue. Click <b>Apply</b> to activate WPS method 2 on the Zyxel Device.
Register	Enter the PIN of the WiFi device that you are setting up a WPS connection with and click <b>Register</b> to authenticate and add the WiFi device to your WiFi network.  You can find the PIN either on the outside of the WiFi device, or by checking the WiFi device's settings.  Note: You must also activate WPS on that WiFi device within 2 minutes to have it present its PIN to the Zyxel Device.
Method 3	Use this section to set up a WPS WiFi network by entering the PIN of the Zyxel Device into the client. Click this switch to make it turn blue. Click <b>Apply</b> to activate WPS method 3 on the Zyxel Device.
Release Configuration	The default WPS status is <b>configured</b> .  Click this button to remove all configured WiFi and WiFi security settings for WPS connections on the Zyxel Device.
Generate New PIN	If this method has been enabled, the PIN (Personal Identification Number) of the Zyxel Device is shown here. Enter this PIN in the configuration utility of the WiFi device you want to connect to using WPS.  The PIN is not necessary when you use the WPS push-button method.  Click the <b>Generate New PIN</b> button to have the Zyxel Device create a new PIN.
Cancel	Click <b>Cancel</b> to restore your previously saved settings.
Apply	Click <b>Apply</b> to save your changes.

## 8.6 WMM

Use this screen to enable WiFi MultiMedia (**WMM**) and **WMM Automatic Power Save Delivery (APSD)** in WiFi networks for multimedia applications. **WMM** enhances data transmission quality, while **APSD** improves power management of WiFi clients. This allows time-sensitive applications, such as voice and videos, to run more smoothly.

Click **Network Setting > Wireless > WMM** to display the following screen.

Figure 95 Network Setting &gt; Wireless &gt; WMM

**WiFi**

General | MAC Authentication | WPS | **WMM** | Others

Enable WiFi MultiMedia (WMM) and WMM Automatic Power Save (APSD) in WiFi networks for delay-sensitive multimedia applications. WMM enhances data transmission quality which allows delay-sensitive applications, such as videos, to run more smoothly. APSD improves power management of WiFi mobile clients. APSD works only if the WiFi device to which the Zyxel Device is connected also supports this feature.

WMM of SSID1

WMM Automatic Power Save Delivery (APSD)

Note

WMM cannot be disabled if 802.11 mode includes 802.11n or 802.11ac.

Cancel    **Apply**

Note: WMM cannot be disabled if 802.11 mode includes 802.11n or 802.11ac.

Note: APSD only affects SSID1. For SSID2-SSID4, APSD is always enabled.

The following table describes the labels in this screen.

Table 43 Network Setting &gt; Wireless &gt; WMM

LABEL	DESCRIPTION
WMM of SSID	Select <b>On</b> to have the Zyxel Device automatically give the WiFi network (SSIDx) a priority level according to the ToS value in the IP header of packets it sends. WMM QoS (WiFi MultiMedia Quality of Service) gives high priority to video, which makes them run more smoothly.  SSID1 is the <b>General</b> WiFi SSID; SSID2-SSID4 are the <b>Guest</b> WiFi SSIDs.  If the <b>802.11 Mode</b> in <b>Network Setting &gt; Wireless &gt; Others</b> is set to include 802.11n or 802.11ac, WMM cannot be disabled.
WMM Automatic Power Save Delivery (APSD)	Select this option to extend the battery life of your mobile devices (especially useful for small devices that are running multimedia applications). The Zyxel Device goes to sleep mode to save power when it is not transmitting data. The AP buffers the packets sent to the Zyxel Device until the Zyxel Device "wakes up." The Zyxel Device wakes up periodically to check for incoming data.  Note: This works only if the WiFi device to which the Zyxel Device is connected also supports this feature.
Cancel	Click <b>Cancel</b> to restore your previously saved settings.
Apply	Click <b>Apply</b> to save your changes.

## 8.7 Others Screen

Use this screen to configure advanced WiFi settings, such as additional security settings, power saving, and data transmission settings. Click **Network Setting > Wireless > Others**. The screen appears as shown.

See [Section 8.11.2 on page 163](#) for detailed definitions of the terms listed here.

**Figure 96** Network Setting > Wireless > Others

RTS/CTS Threshold	<input type="text" value="2347"/>	
Fragmentation Threshold	<input type="text" value="2346"/>	
Output Power	<input type="text" value="100%"/>	▼
Beacon Interval	<input type="text" value="100"/>	ms
DTIM Interval	<input type="text" value="1"/>	ms
802.11 Mode	<input type="text" value="802.11b/g/n/ax Mixed"/>	▼
802.11 Protection	<input type="text" value="Auto"/>	▼
Preamble	<input type="text" value="Long"/>	
Protected Management Frames	<input type="text" value="Capable"/>	▼
<input type="button" value="Cancel"/> <input type="button" value="Apply"/>		

The following table describes the labels in this screen.

**Table 44** Network Setting > Wireless > Others

LABEL	DESCRIPTION
RTS/CTS Threshold	Data with its frame size larger than this value will perform the RTS (Request To Send)/CTS (Clear To Send) handshake. Enter a value between 0 and 2347.
Fragmentation Threshold	This is the maximum data fragment size that can be sent. Enter a value between 256 and 2346.
Output Power	Set the output power of the Zyxel Device. If there is a high density of APs in an area, decrease the output power to reduce interference with other APs. Select one of the following: <b>20%, 40%, 60%, 80% or 100%</b> .
Beacon Interval	When a wirelessly networked device sends a beacon, it includes with it a beacon interval. This specifies the time period before the device sends the beacon again.  The interval tells receiving devices on the network how long they can wait in low power mode before waking up to handle the beacon. This value can be set from 50 ms to 1000 ms. A high value helps save current consumption of the access point.
DTIM Interval	Delivery Traffic Indication Message (DTIM) is the time period after which broadcast and Multicast packets are transmitted to mobile clients in the Power Saving mode. A high DTIM value can cause clients to lose connectivity with the network. This value can be set from 1 to 255.

Table 44 Network Setting &gt; Wireless &gt; Others (continued)

LABEL	DESCRIPTION
802.11 Mode	<p>For 2.4 GHz frequency WiFi devices:</p> <ul style="list-style-type: none"> <li>• Select <b>802.11b Only</b> to allow only IEEE 802.11b compliant WiFi devices to associate with the Zyxel Device.</li> <li>• Select <b>802.11g Only</b> to allow only IEEE 802.11g compliant WiFi devices to associate with the Zyxel Device.</li> <li>• Select <b>802.11n Only</b> to allow only IEEE 802.11n compliant WiFi devices to associate with the Zyxel Device.</li> <li>• Select <b>802.11b/g Mixed</b> to allow either IEEE 802.11b or IEEE 802.11g compliant WiFi devices to associate with the Zyxel Device. The transmission rate of your Zyxel Device might be reduced.</li> <li>• Select <b>802.11b/g/n Mixed</b> to allow IEEE 802.11b, IEEE 802.11g or IEEE 802.11n compliant WiFi devices to associate with the Zyxel Device. The transmission rate of your Zyxel Device might be reduced.</li> </ul> <p>For 5 GHz frequency WiFi devices:</p> <ul style="list-style-type: none"> <li>• Select <b>802.11a Only</b> to allow only IEEE 802.11a compliant WiFi devices to associate with the Zyxel Device.</li> <li>• Select <b>802.11n Only</b> to allow only IEEE 802.11n compliant WiFi devices to associate with the Zyxel Device.</li> <li>• Select <b>802.11ac Only</b> to allow only IEEE 802.11ac compliant WiFi devices to associate with the Zyxel Device.</li> <li>• Select <b>802.11a/n Mixed</b> to allow either IEEE 802.11a or IEEE 802.11n compliant WiFi devices to associate with the Zyxel Device. The transmission rate of your Zyxel Device might be reduced.</li> <li>• Select <b>802.11n/ac Mixed</b> to allow either IEEE 802.11n or IEEE 802.11ac compliant WiFi devices to associate with the Zyxel Device. The transmission rate of your Zyxel Device might be reduced.</li> <li>• Select <b>802.11a/n/ac Mixed</b> to allow IEEE 802.11a, IEEE 802.11n or IEEE 802.11ac compliant WiFi devices to associate with the Zyxel Device. The transmission rate of your Zyxel Device might be reduced.</li> </ul>
802.11 Protection	<p>Enabling this feature can help prevent collisions in mixed-mode networks (networks with both IEEE 802.11b and IEEE 802.11g traffic).</p> <p>Select <b>Auto</b> to have the wireless devices transmit data after a RTS/CTS handshake. This helps improve IEEE 802.11g performance.</p> <p>Select <b>Off</b> to disable 802.11 protection. The transmission rate of your Zyxel Device might be reduced in a mixed-mode network.</p> <p>This field displays <b>Off</b> and is not configurable when you set <b>802.11 Mode</b> to <b>802.11b Only</b>.</p>
Preamble	<p>Select a preamble type from the drop-down list box. Choices are <b>Long</b> or <b>Short</b>. See <a href="#">Section 8.11.7 on page 166</a> for more information.</p> <p>This field is configurable only when you set 802.11 Mode to <b>802.11b</b>.</p>
Cancel	Click <b>Cancel</b> to restore your previously saved settings.
Apply	Click <b>Apply</b> to save your changes.

## 8.8 Channel Status

Use this screen to scan for WiFi channel noise and view the results. Click **Scan** to start, and then view the results in the **Channel Scan Result** section. The value on each channel number indicates the number of Access Points (AP) using that channel. The Auto-channel-selection algorithm does not always directly follow the AP count; other factors about the channels are also considered. Click **Network Setting > Wireless > Channel Status**. The screen appears as shown.

Note: If the current channel is a DFS channel, the warning 'Channel scan process is denied because current channel is a DFS channel (Channel: 52 – 140). If you want to run channel scan, please select a non-DFS channel and try again.' appears.

Note: The AP count may not be a real-time value.

**Figure 97** Network Setting > Wireless > Channel Status

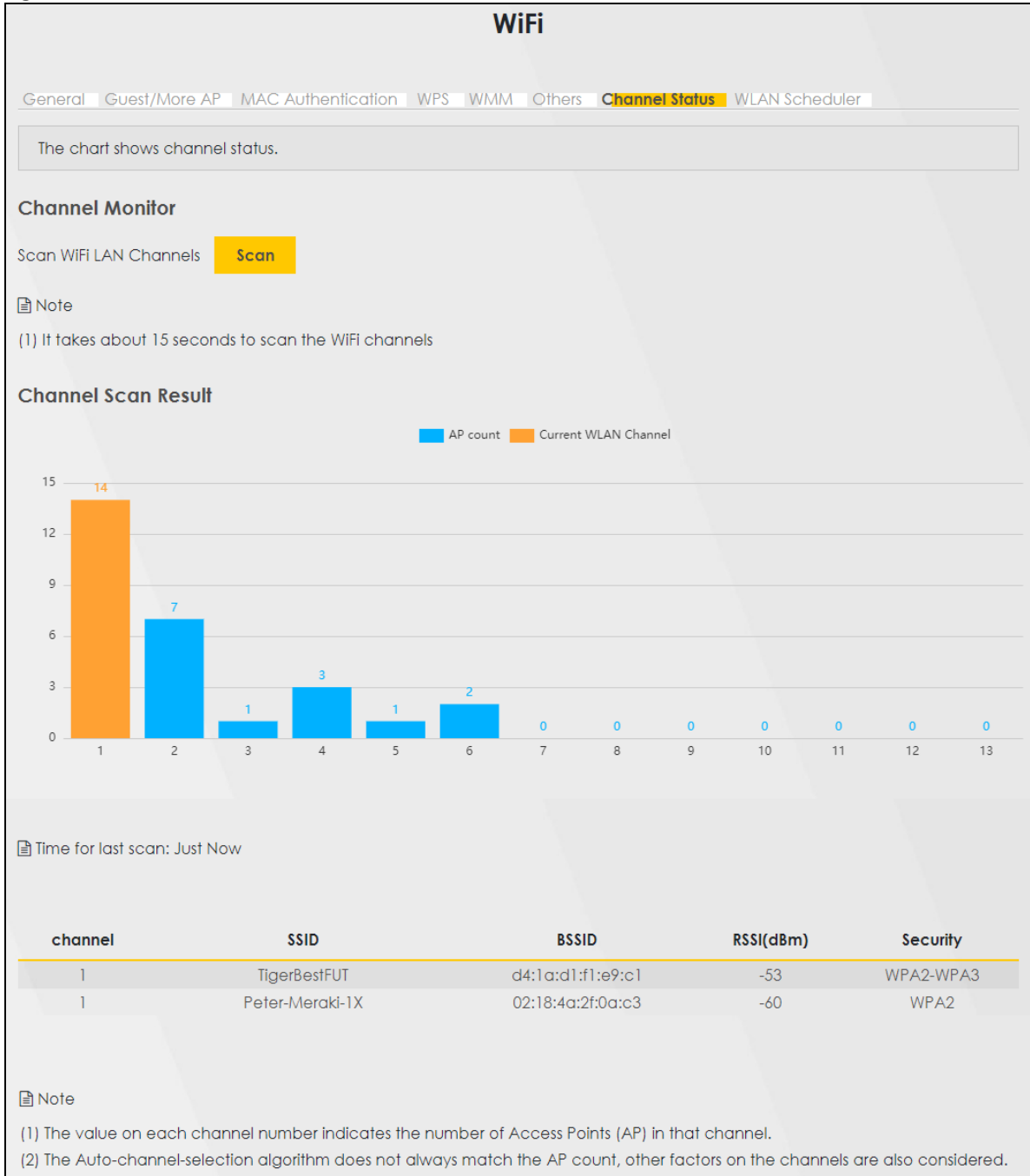

The following table describes the labels in this screen.

Table 45 Network Setting > Wireless > Channel Status

LABEL	DESCRIPTION
Channel Monitor	
Scan WiFi LAN Channels	Click the <b>Scan</b> button to scan WiFi channels.
Channel Scan Result	This displays the results of the channel scan. The blue bar displays the number of access points ( <b>AP count</b> ) in the WiFi channel. The orange bar displays the WiFi channel that the Zyxel Device is now using.
Time for last scan	This displays the time when you last click the <b>Scan</b> button.
Channel	This displays the channel number currently used by the WiFi interface.
SSID	This displays the descriptive name used to identify the Zyxel Device in a WLAN.
BSSID	This displays the MAC address of the WiFi interface on the Zyxel Device when WiFi is enabled.
RSSI (dBm)	The RSSI (Received Signal Strength Indicator) field displays the WiFi signal strength of the station's WiFi connection.  The normal range is -30 dBm to -79 dBm. If the value drops below -80 dBm, try moving the associated WiFi station closer to the Zyxel Device to get better signal strength.
Security	This displays the type of security mode the WiFi interface is using in the WLAN.

## 8.9 WLAN Scheduler

Use the **WLAN Scheduler** screen to create rules to schedule the times to permit Internet traffic from each WiFi network interfaces. Select a specific time and day of a week for scheduling. You can also create a rule to automatically switch off all the WLAN together.

Click **Network Setting > Wireless > WLAN Scheduler**.

Figure 98 Network Setting &gt; Wireless &gt; WLAN Scheduler

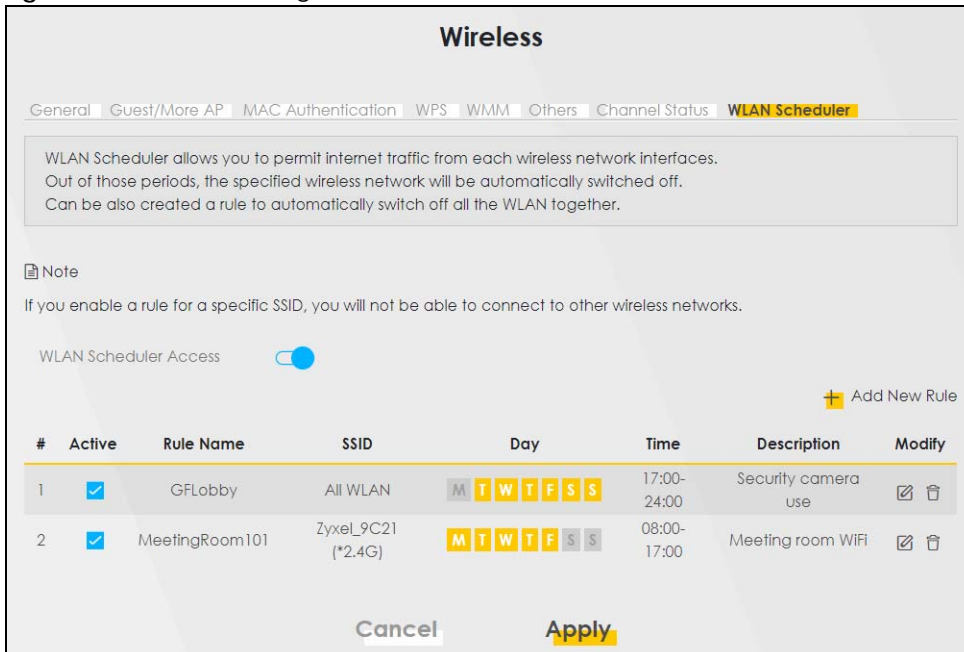

The following table describes the labels in this screen.

Table 46 Network Setting &gt; Wireless &gt; WLAN Scheduler

LABEL	DESCRIPTION
WLAN Scheduler Access	Click this switch to enable the WLAN scheduler function. This serves as the main switch to allow the individual rules to function.
Add New Rule	Click this to configure a new WLAN scheduler rule.
#	This is the index number of the entry.
Active	Click the check box to enable individual rules.  Note: Make sure to enable the <b>WLAN Scheduler Access</b> switch for the individual rules to work.
Rule Name	This field displays the name of the rule.
SSID	This is the descriptive name used to identify the wireless network interface that this rule applies to. Will show <b>ALL WLAN</b> if you select <b>All wireless networks</b> in the <b>Add New Rule</b> screen.
Day	This field displays the days of the week that you wish to apply this rule.
Time	This field displays the time of the day that you wish to apply this rule.
Description	This field shows a description of the rule, usually to help identify it.
Modify	Click the <b>Edit</b> icon to configure the rule.  Click the <b>Delete</b> icon to remove the rule.

Note: If you enable a rule for a specific SSID, you will not be able to connect to other wireless networks.

### 8.9.1 Add or Edit Rules

Click **Add New Rule** in the **WLAN Scheduler** screen, or click the **Edit** icon next to a scheduling rule, and the following screen displays.

Use this screen to create a scheduling rule to permit Internet traffic from each wireless network interface.

**Figure 99** Network Setting > Wireless > WLAN Scheduler > Add New Rule

The following table describes the labels in this screen.

**Table 47** Network Setting > Wireless > WLAN Schedule > Add New Rule

LABEL	DESCRIPTION
Active	Click this switch to enable this WLAN scheduler rule.
SSID	Select <b>All wireless networks</b> if you want the rule to apply to all WiFi network interfaces or select a WiFi network interface to apply the rule to.
Rule Name	Enter a descriptive name for the rule.
Day	Select the days of the week that you wish to apply this rule.
Time of Day Range	Specify the time of the day that you wish to apply to this rule (format <b>hh:mm</b> ).  Note: Click the check box for <b>All days</b> if you wish to apply the rule for the whole day (24 hours).
Description	Enter a description of the rule, usually to help identify it (its purpose).
OK	Click <b>OK</b> to save the changes back to the Zyxel Device.
Cancel	Click <b>Cancel</b> to close the window with changes unsaved.

## 8.10 EasyMesh

Use this screen to enable or disable **EasyMesh Controller** on the Zyxel Device. Click **Network > Wireless > EasyMesh** to open the following screen.

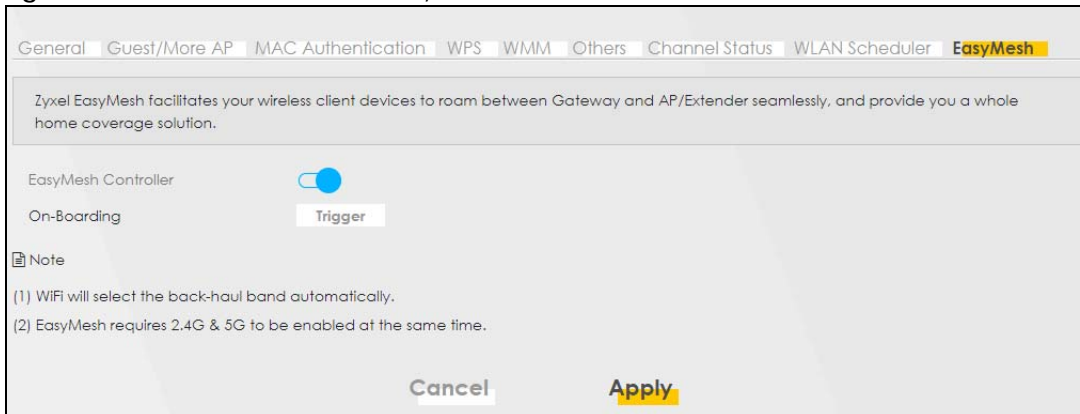

**Figure 100** Network > Wireless > EasyMesh

The following table describes the labels in this screen.

**Table 48** Network Setting > Wireless > EasyMesh

LABEL	DESCRIPTION
EasyMesh Controller	Slide the switch to the right (  ) to enable <b>EasyMesh Controller</b> .
On-Boarding	To enable WPS, click the <b>Trigger</b> button until the WPS LED blink green. Press the WPS button on the client device within 150 seconds.
OK	Click <b>OK</b> to save the changes back to the Zyxel Device.
Cancel	Click <b>Cancel</b> to close the window with changes unsaved.

## 8.11 Technical Reference

This section discusses WiFi in depth.

### 8.11.1 WiFi Network Overview

WiFi networks consist of WiFi clients, access points and bridges.

- A WiFi client is a radio connected to a user's computer.
- An access point is a radio with a wired connection to a network, which can connect with numerous WiFi clients and let them access the network.
- A bridge is a radio that relays communications between access points and WiFi clients, extending a network's range.

Normally, a WiFi network operates in an "infrastructure" type of network. An "infrastructure" type of network has one or more access points and one or more WiFi clients. The WiFi clients connect to the access points.

The following figure provides an example of a WiFi network.

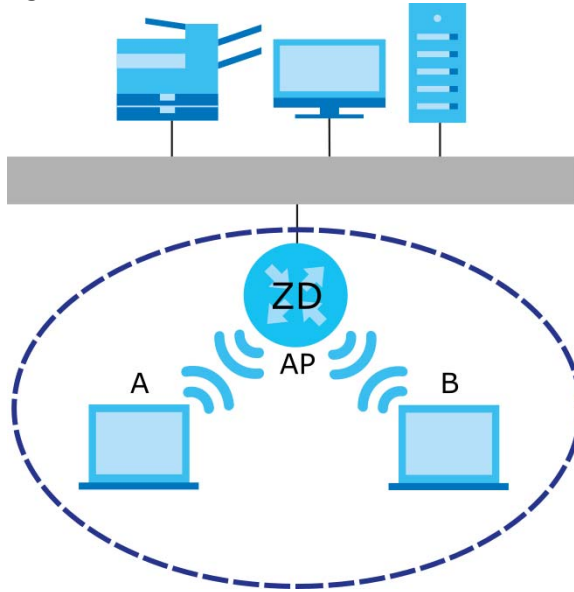
**Figure 101** Example of a WiFi Network

The WiFi network is the part in the blue circle. In this WiFi network, devices **A** and **B** use the access point (**AP**) to interact with the other devices (such as the printer) or with the Internet. Your Zykel Device is the AP.

Every WiFi network must follow these basic guidelines.

- Every WiFi device in the same WiFi network must use the same SSID.  
The SSID is the name of the WiFi network. It stands for Service Set Identifier.
- If two WiFi networks overlap, they should use a different channel.  
Like radio stations or television channels, each WiFi network uses a specific channel, or frequency, to send and receive information.
- Every WiFi device in the same WiFi network must use security compatible with the AP.  
Security stops unauthorized devices from using the WiFi network. It can also protect the information that is sent in the WiFi network.

## 8.11.2 Additional WiFi Terms

The following table describes some WiFi network terms and acronyms used in the Zyxel Device's Web Configurator.

Table 49 Additional WiFi Terms

TERM	DESCRIPTION
RTS/CTS Threshold	<p>In a WiFi network which covers a large area, WiFi devices are sometimes not aware of each other's presence. This may cause them to send information to the AP at the same time and result in information colliding and not getting through.</p> <p>By setting this value lower than the default value, the WiFi devices must sometimes get permission to send information to the Zyxel Device. The lower the value, the more often the devices must get permission.</p> <p>If this value is greater than the fragmentation threshold value (see below), then WiFi devices never have to get permission to send information to the Zyxel Device.</p>
Preamble	A preamble affects the timing in your WiFi network. There are two preamble modes: long and short. If a WiFi device uses a different preamble mode than the Zyxel Device does, it cannot communicate with the Zyxel Device.
Authentication	The process of verifying whether a WiFi device is allowed to use the WiFi network.
Fragmentation Threshold	A small fragmentation threshold is recommended for busy networks, while a larger threshold provides faster performance if the network is not very busy.

## 8.11.3 WiFi Security Overview

By their nature, radio communications are simple to intercept. For WiFi data networks, this means that anyone within range of a WiFi network without security can not only read the data passing over the airwaves, but also join the network. Once an unauthorized person has access to the network, he or she can steal information or introduce malware (malicious software) intended to compromise the network. For these reasons, a variety of security systems have been developed to ensure that only authorized people can use a WiFi data network, or understand the data carried on it.

These security standards do two things. First, they authenticate. This means that only people presenting the right credentials (often a username and password, or a "key" phrase) can access the network. Second, they encrypt. This means that the information sent over the air is encoded. Only people with the code key can understand the information, and only people who have been authenticated are given the code key.

These security standards vary in effectiveness. Some can be broken, such as the old Wired Equivalent Protocol (WEP). Using WEP is better than using no security at all, but it will not keep a determined attacker out. Other security standards are secure in themselves but can be broken if a user does not use them properly. For example, the WPA-PSK security standard is very secure if you use a long key which is difficult for an attacker's software to guess – for example, a twenty-letter long string of apparently random numbers and letters – but it is not very secure if you use a short key which is very easy to guess – for example, a three-letter word from the dictionary.

Because of the damage that can be done by a malicious attacker, it is not just people who have sensitive information on their network who should use security. Everybody who uses any WiFi network should ensure that effective security is in place.

A good way to come up with effective security keys, passwords and so on is to use obscure information that you personally will easily remember, and to enter it in a way that appears random and does not include real words. For example, if your mother owns a 1970 Dodge Challenger and her favorite movie is

Vanishing Point (which you know was made in 1971) you could use "70dodchal71vanpoi" as your security key.

The following sections introduce different types of WiFi security you can set up in the WiFi network.

### 8.11.3.1 SSID

Normally, the Zyxel Device acts like a beacon and regularly broadcasts the SSID in the area. You can hide the SSID instead, in which case the Zyxel Device does not broadcast the SSID. In addition, you should change the default SSID to something that is difficult to guess.

This type of security is fairly weak, however, because there are ways for unauthorized WiFi devices to get the SSID. In addition, unauthorized WiFi devices can still see the information that is sent in the WiFi network.

### 8.11.3.2 MAC Address Filter

Every device that can use a WiFi network has a unique identification number, called a MAC address.<sup>1</sup> A MAC address is usually written using twelve hexadecimal characters<sup>2</sup>; for example, 00A0C5000002 or 00:A0:C5:00:00:02. To get the MAC address for each WiFi device in the WiFi network, see the WiFi device's User's Guide or other documentation.

You can use the MAC address filter to tell the Zyxel Device which devices are allowed or not allowed to use the WiFi network. If a WiFi device is allowed to use the WiFi network, it still has to have the correct information (SSID, channel, and security). If a WiFi device is not allowed to use the WiFi network, it does not matter if it has the correct information.

This type of security does not protect the information that is sent in the WiFi network. Furthermore, there are ways for unauthorized WiFi devices to get the MAC address of an authorized WiFi device. Then, they can use that MAC address to use the WiFi network.

### 8.11.3.3 Encryption

WiFi networks can use encryption to protect the information that is sent in the WiFi network. Encryption is like a secret code. If you do not know the secret code, you cannot understand the message.

The types of encryption you can choose depend on the type of authentication. (See [Section 8.11.3.3 on page 164](#) for information about this.)

Table 50 Types of Encryption for Each Type of Authentication

	NO AUTHENTICATION	RADIUS SERVER
<b>Weakest</b>	No Security	WPA
	WPA-PSK	WPA2
	WPA2	
<b>Strongest</b>	WPA3-SAE	WPA3 (server certificate validation)

1. Some wireless devices, such as scanners, can detect WiFi networks but cannot use WiFi networks. These kinds of wireless devices might not have MAC addresses.

2. Hexadecimal characters are 0, 1, 2, 3, 4, 5, 6, 7, 8, 9, A, B, C, D, E, and F.

For example, if the WiFi network has a RADIUS server, you can choose **WPA**, **WPA2**, or **WPA3**. If users do not log in to the WiFi network, you can choose no encryption, **WPA2-PSK**, or **WPA3-SAE**.

Note: It is recommended that WiFi networks use **WPA3-SAE**, **WPA2-PSK**, or stronger encryption. The other types of encryption are better than none at all, but it is still possible for unauthorized WiFi devices to figure out the original information pretty quickly.

Many types of encryption use a key to protect the information in the WiFi network. The longer the key, the stronger the encryption. Every device in the WiFi network must have the same key.

## 8.11.4 Signal Problems

Because WiFi networks are radio networks, their signals are subject to limitations of distance, interference and absorption.

Problems with distance occur when the two radios are too far apart. Problems with interference occur when other radio waves interrupt the data signal. Interference may come from other radio transmissions, such as military or air traffic control communications, or from machines that are coincidental emitters such as electric motors or microwaves. Problems with absorption occur when physical objects (such as thick walls) are between the two radios, muffling the signal.

## 8.11.5 BSS

A Basic Service Set (BSS) exists when all communications between wireless stations go through one access point (AP).

Intra-BSS traffic is traffic between wireless stations in the BSS. When Intra-BSS traffic blocking is disabled, wireless station A and B can access the wired network and communicate with each other. When Intra-BSS traffic blocking is enabled, wireless station A and B can still access the wired network but cannot communicate with each other.

Figure 102 Basic Service Set

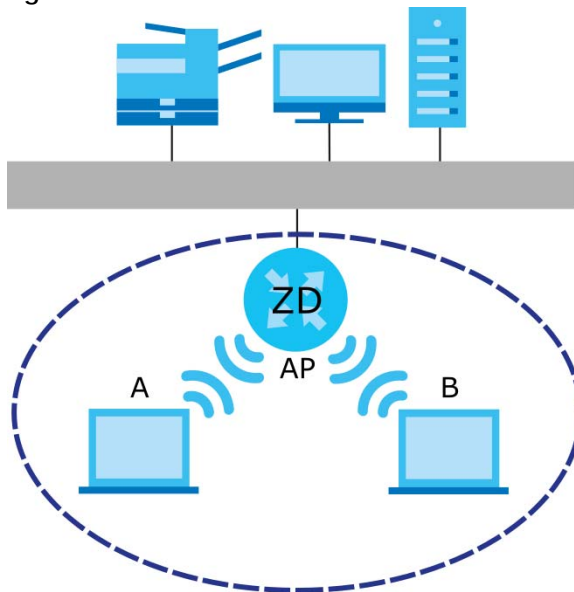

## 8.11.6 MBSSID

Traditionally, you need to use different APs to configure different Basic Service Sets (BSSs). As well as the cost of buying extra APs, there is also the possibility of channel interference. The Zyxel Device's MBSSID (Multiple Basic Service Set Identifier) function allows you to use one access point to provide several BSSs simultaneously. You can then assign varying QoS priorities and/or security modes to different SSIDs.

Wireless devices can use different BSSIDs to associate with the same AP.

### 8.11.6.1 Notes on Multiple BSSs

- A maximum of eight BSSs are allowed on one AP simultaneously.
- You must use different keys for different BSSs. If two wireless devices have different BSSIDs (they are in different BSSs), but have the same keys, they may hear each other's communications (but not communicate with each other).
- MBSSID should not replace but rather be used in conjunction with 802.1x security.

## 8.11.7 Preamble Type

Preamble is used to signal that data is coming to the receiver. Short and long refer to the length of the synchronization field in a packet.

Short preamble increases performance as less time sending preamble means more time for sending data. All IEEE 802.11 compliant WiFi adapters support long preamble, but not all support short preamble.

Use long preamble if you are unsure what preamble mode other WiFi devices on the network support, and to provide more reliable communications in busy WiFi networks.

Use short preamble if you are sure all WiFi devices on the network support it, and to provide more efficient communications.

Use the dynamic setting to automatically use short preamble when all WiFi devices on the network support it, otherwise the Zyxel Device uses long preamble.

Note: The WiFi devices MUST use the same preamble mode in order to communicate.

## 8.11.8 WiFi Protected Setup (WPS)

Your Zyxel Device supports WiFi Protected Setup (WPS), which is an easy way to set up a secure WiFi network. WPS is an industry standard specification, defined by the WiFi Alliance.

WPS allows you to quickly set up a WiFi network with strong security, without having to configure security settings manually. Each WPS connection works between two devices. Both devices must support WPS (check each device's documentation to make sure).

Depending on the devices you have, you can either press a button (on the device itself, or in its configuration utility) or enter a PIN (a unique Personal Identification Number that allows one device to authenticate the other) in each of the two devices. When WPS is activated on a device, it has 2 minutes to find another device that also has WPS activated. Then, the two devices connect and set up a secure network by themselves.

### 8.11.8.1 Push Button Configuration

WPS Push Button Configuration (PBC) is initiated by pressing a button on each WPS-enabled device, and allowing them to connect automatically. You do not need to enter any information.

Not every WPS-enabled device has a physical WPS button. Some may have a WPS PBC button in their configuration utilities instead of or in addition to the physical button.

Take the following steps to set up WPS using the button.

- 1 Ensure that the two devices you want to set up are within WiFi range of one another.
- 2 Look for a WPS button on each device. If the device does not have one, log into its configuration utility and locate the button (see the device's User's Guide for how to do this – for the Zyxel Device).
- 3 Press the button on one of the devices (it does not matter which). For the Zyxel Device you must press the **WiFi** button for more than 5 seconds.
- 4 Within 2 minutes, press the button on the other device. The registrar sends the network name (SSID) and security key through a secure connection to the enrollee.

If you need to make sure that WPS worked, check the list of associated WiFi clients in the AP's configuration utility. If you see the WiFi client in the list, WPS was successful.

### 8.11.8.2 PIN Configuration

Each WPS-enabled device has its own PIN (Personal Identification Number). This may either be static (it cannot be changed) or dynamic (in some devices you can generate a new PIN by clicking on a button in the configuration interface).

Use the PIN method instead of the push-button configuration (PBC) method if you want to ensure that the connection is established between the devices you specify, not just the first two devices to activate WPS in range of each other. However, you need to log into the configuration interfaces of both devices to use the PIN method.

When you use the PIN method, you must enter the PIN from one device (usually the WiFi client) into the second device (usually the Access Point or wireless router). Then, when WPS is activated on the first device, it presents its PIN to the second device. If the PIN matches, one device sends the network and security information to the other, allowing it to join the network.

Take the following steps to set up a WPS connection between an access point or wireless router (referred to here as the AP) and a client device using the PIN method.

- 1 Ensure WPS is enabled on both devices.
- 2 Access the WPS section of the AP's configuration interface. See the device's User's Guide on how to do this.
- 3 Look for the client's WPS PIN; it will be displayed either on the device, or in the WPS section of the client's configuration interface (see the device's User's Guide on how to find the WPS PIN – for the Zyxel Device, see [Section 8.5 on page 151](#)).
- 4 Enter the client's PIN in the AP's configuration interface.

- 5 If the client device's configuration interface has an area for entering another device's PIN, you can either enter the client's PIN in the AP, or enter the AP's PIN in the client – it does not matter which.
- 6 Start WPS on both devices within two minutes.
- 7 Use the configuration utility to activate WPS, not the push-button on the device itself.
- 8 On a computer connected to the WiFi client, try to connect to the Internet. If you can connect, WPS was successful.

If you cannot connect, check the list of associated WiFi clients in the AP's configuration utility. If you see the WiFi client in the list, WPS was successful.

The following figure shows a WPS-enabled WiFi client (installed in a notebook computer) connecting to the WPS-enabled AP through the PIN method.

**Figure 103** Example WPS Process: PIN Method

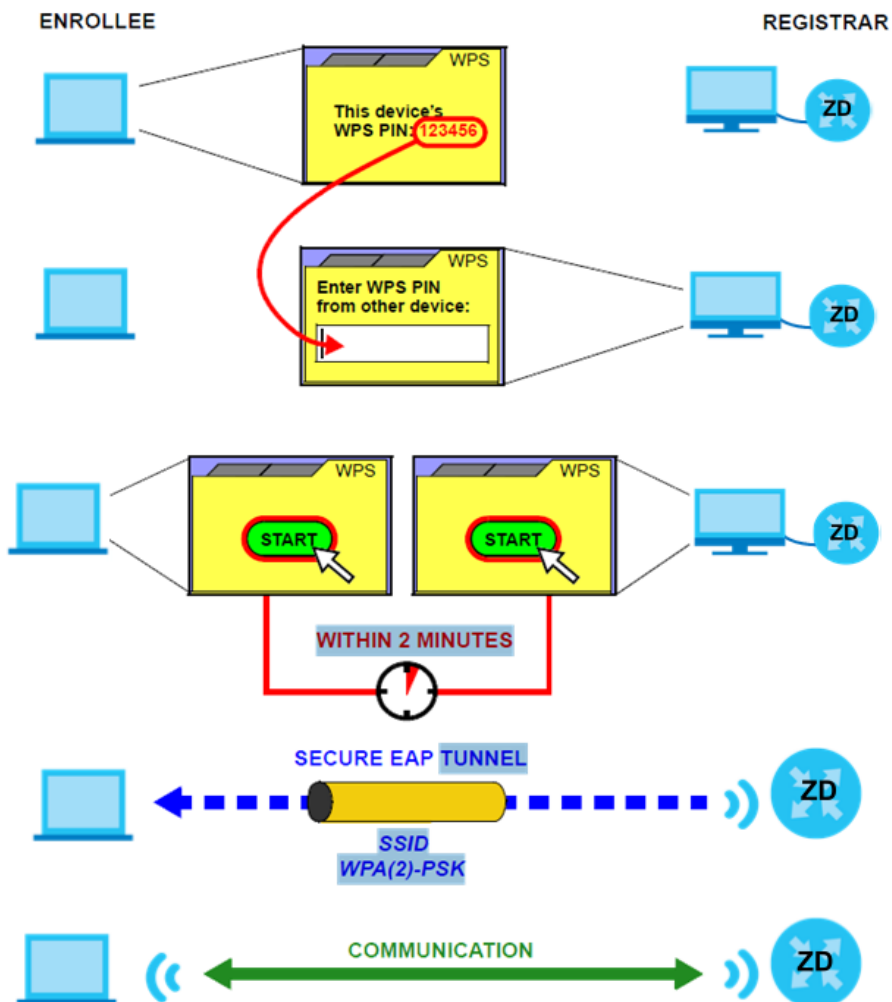

### 8.11.8.3 How WPS Works

When two WPS-enabled devices connect, each device must assume a specific role. One device acts as the registrar (the device that supplies network and security settings) and the other device acts as the enrollee (the device that receives network and security settings). The registrar creates a secure EAP



(Extensible Authentication Protocol) tunnel and sends the network name (SSID) and the WPA-PSK or WPA2-PSK pre-shared key to the enrollee. Whether WPA-PSK or WPA2-PSK is used depends on the standards supported by the devices. If the registrar is already part of a network, it sends the existing information. If not, it generates the SSID and WPA2-PSK randomly.

The following figure shows a WPS-enabled client (installed in a notebook computer) connecting to a WPS-enabled access point.

Figure 104 How WPS Works

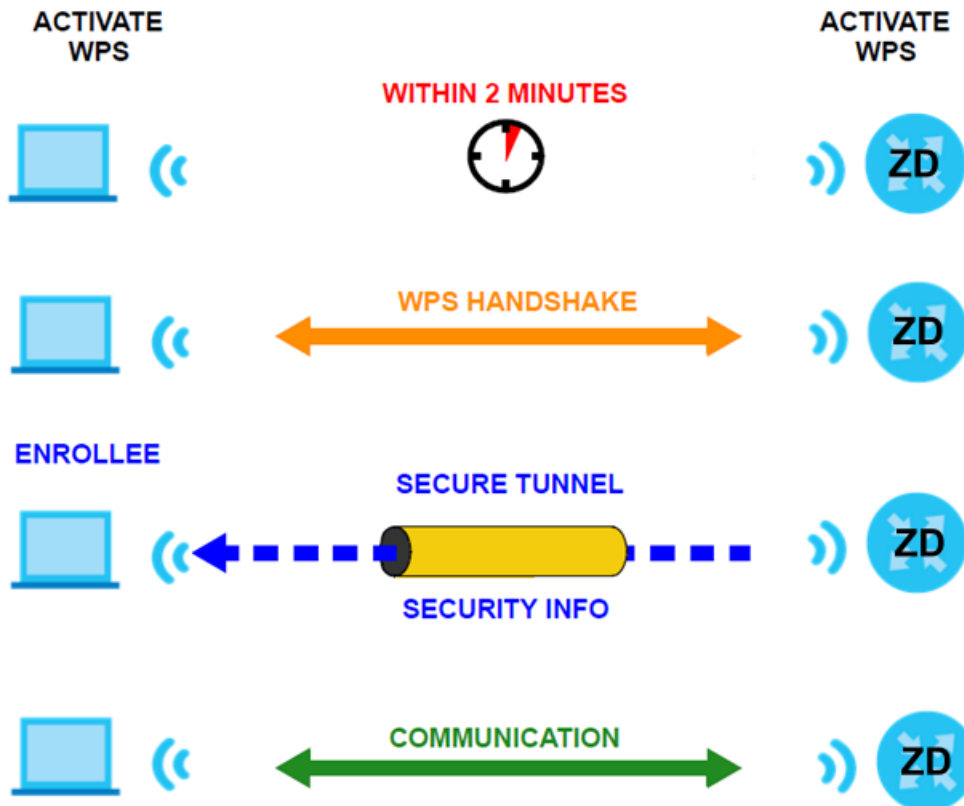

The roles of registrar and enrollee last only as long as the WPS setup process is active (2 minutes). The next time you use WPS, a different device can be the registrar if necessary.

The WPS connection process is like a handshake; only two devices participate in each WPS transaction. If you want to add more devices you should repeat the process with one of the existing networked devices and the new device.

Note that the access point (AP) is not always the registrar, and the WiFi client is not always the enrollee. All WPS-certified APs can be a registrar, and so can some WPS-enabled WiFi clients.

By default, a WPS device is 'un-configured'. This means that it is not part of an existing network and can act as either enrollee or registrar (if it supports both functions). If the registrar is un-configured, the security settings it transmits to the enrollee are randomly-generated. Once a WPS-enabled device has connected to another device using WPS, it becomes 'configured'. A configured WiFi client can still act as enrollee or registrar in subsequent WPS connections, but a configured access point can no longer act as enrollee. It will be the registrar in all subsequent WPS connections in which it is involved. If you want a configured AP to act as an enrollee, you must reset it to its factory defaults.

### 8.11.8.4 Example WPS Network Setup

This section shows how security settings are distributed in a sample WPS setup.

The following figure shows a sample network. In step 1, both **AP1** and **Client 1** are un-configured. When WPS is activated on both, they perform the handshake. In this example, **AP1** is the registrar, and **Client 1** is the enrollee. The registrar randomly generates the security information to set up the network, since it is un-configured and has no existing information.

Figure 105 WPS: Example Network Step 1



In step 2, you add another WiFi client to the network. You know that **Client 1** supports registrar mode, but it is better to use **AP1** for the WPS handshake with the new client since you must connect to the access point anyway in order to use the network. In this case, **AP1** must be the registrar, since it is configured (it already has security information for the network). **AP1** supplies the existing security information to **Client 2**.

Figure 106 WPS: Example Network Step 2

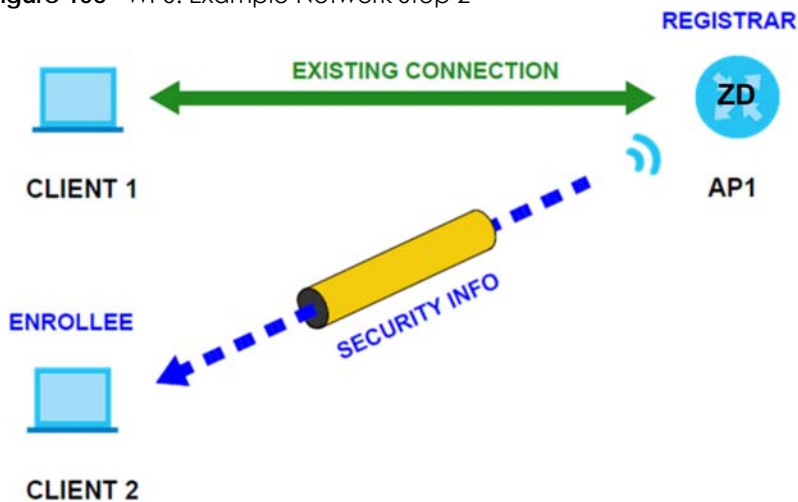

In step 3, you add another access point (**AP2**) to your network. **AP2** is out of range of **AP1**, so you cannot use **AP1** for the WPS handshake with the new access point. However, you know that **Client 2** supports the registrar function, so you use it to perform the WPS handshake instead.

Figure 107 WPS: Example Network Step 3

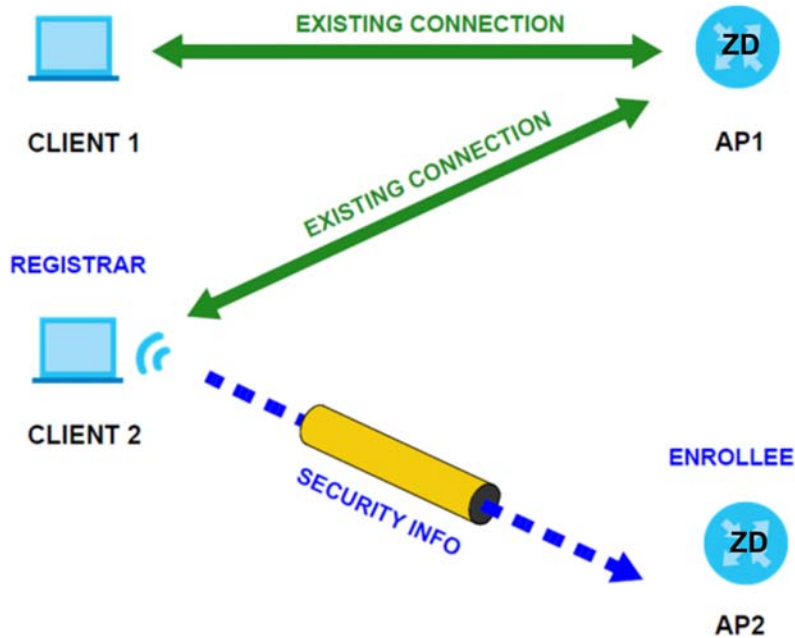

### 8.11.8.5 Limitations of WPS

WPS has some limitations of which you should be aware.

- When you use WPS, it works between two devices only. You cannot enroll multiple devices simultaneously, you must enroll one after the other.

For instance, if you have two enrollees and one registrar you must set up the first enrollee (by pressing the WPS button on the registrar and the first enrollee, for example), then check that it was successfully enrolled, then set up the second device in the same way.

- WPS works only with other WPS-enabled devices. However, you can still add non-WPS devices to a network you already set up using WPS.

WPS works by automatically issuing a randomly-generated WPA-PSK or WPA2-PSK pre-shared key from the registrar device to the enrollee devices. Whether the network uses WPA-PSK or WPA2-PSK depends on the device. You can check the configuration interface of the registrar device to discover the key the network is using (if the device supports this feature). Then, you can enter the key into the non-WPS device and join the network as normal (the non-WPS device must also support WPA-PSK or WPA2-PSK).

- When you use the PBC method, there is a short period (from the moment you press the button on one device to the moment you press the button on the other device) when any WPS-enabled device could join the network. This is because the registrar has no way of identifying the 'correct' enrollee, and cannot differentiate between your enrollee and a rogue device. This is a possible way for a hacker to gain access to a network.

You can easily check to see if this has happened. WPS only works simultaneously between two devices, so if another device has enrolled your device will be unable to enroll, and will not have access to the network. If this happens, open the access point's configuration interface and look at the list of associated clients (usually displayed by MAC address). It does not matter if the access point is the WPS registrar, the enrollee, or was not involved in the WPS handshake; a rogue device must still associate with the access point to gain access to the network. Check the MAC addresses of your WiFi clients (usually printed on a label on the bottom of the device). If there is an unknown MAC address you can remove it or reset the AP.

# CHAPTER 9

## Home Networking

### 9.1 Home Networking Overview

A Local Area Network (LAN) is a shared communication system to which many computers are attached. A LAN is usually located in one immediate area such as a building or floor of a building.

The LAN screens can help you configure a LAN DHCP server and manage IP addresses.

**Figure 108** Home Networking Example

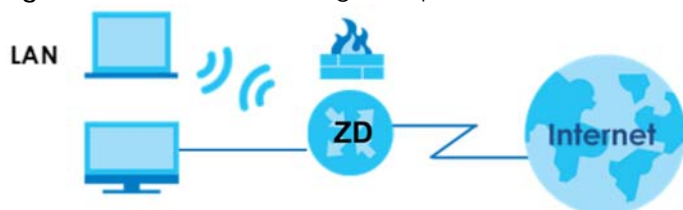

#### 9.1.1 What You Can Do in this Chapter

- Use the **LAN Setup** screen to set the LAN IP address, subnet mask, and DHCP settings ([Section 9.2 on page 174](#)).
- Use the **Static DHCP** screen to assign IP addresses on the LAN to specific individual computers based on their MAC addresses ([Section 9.3 on page 178](#)).
- Use the **UPnP** screen to enable UPnP ([Section 9.4 on page 180](#)).

#### 9.1.2 What You Need To Know

The following terms and concepts may help as you read this chapter.

##### 9.1.2.1 About LAN

###### IP Address

Similar to the way houses on a street share a common street name, so too do computers on a LAN share one common network number. This is known as an Internet Protocol address.

###### Subnet Mask

The subnet mask specifies the network number portion of an IP address. Your Zyxel Device will compute the subnet mask automatically based on the IP address that you entered. You do not need to change the subnet mask computed by the Zyxel Device unless you are instructed to do otherwise.

## DHCP

DHCP (Dynamic Host Configuration Protocol) allows clients to obtain TCP/IP configuration at start-up from a server. This Zyxel Device has a built-in DHCP server capability that assigns IP addresses and DNS servers to systems that support DHCP client capability.

## DNS

DNS (Domain Name System) maps a domain name to its corresponding IP address and vice versa. The DNS server is extremely important because without it, you must know the IP address of a computer before you can access it. The DNS server addresses you enter when you set up DHCP are passed to the client machines along with the assigned IP address and subnet mask.

### 9.1.2.2 About UPnP

#### How do I know if I am using UPnP?

UPnP hardware is identified as an icon in the Network Connections folder (Windows 7). Each UPnP compatible device installed on your network will appear as a separate icon. Selecting the icon of a UPnP device will allow you to access the information and properties of that device.

#### NAT Traversal

UPnP NAT traversal automates the process of allowing an application to operate through NAT. UPnP network devices can automatically configure network addressing, announce their presence in the network to other UPnP devices and enable exchange of simple product and service descriptions. NAT traversal allows the following:

- Dynamic port mapping
- Learning public IP addresses
- Assigning lease times to mappings

Windows Messenger is an example of an application that supports NAT traversal and UPnP.

#### Cautions with UPnP

The automated nature of NAT traversal applications in establishing their own services and opening firewall ports may present network security issues. Network information and configuration may also be obtained and modified by users in some network environments.

When a UPnP device joins a network, it announces its presence with a Multicast message. For security reasons, the Zyxel Device allows Multicast messages on the LAN only.

All UPnP-enabled devices may communicate freely with each other without additional configuration. Disable UPnP if this is not your intention.

#### UPnP and Zyxel

Zyxel has achieved UPnP certification from the Universal Plug and Play Forum UPnP™ Implementers Corp. (UIC).

See [Section 9.6 on page 184](#) for examples on installing and using UPnP.

## 9.2 LAN Setup

A LAN IP address is the IP address of a networking device in the LAN. You can use the Zyxel Device's LAN IP address to access its Web Configurator from the LAN. The DHCP server settings define the rules on assigning IP addresses to LAN clients on your network.

Use this screen to set the Local Area Network IP address and subnet mask of your Zyxel Device. Configure DHCP settings to have the Zyxel Device or a DHCP server assign IP addresses to devices. Click **Network Setting > Home Networking** to open the **LAN Setup** screen.

Follow these steps to configure your LAN settings.

- 1** Enter an IP address into the **IP Address** field. The IP address must be in dotted decimal notation. This will become the IP address of your Zyxel Device.
- 2** Enter the IP subnet mask into the **IP Subnet Mask** field. Unless instructed otherwise it is best to leave this alone, the configurator will automatically compute a subnet mask based upon the IP address you entered.
- 3** Click **Apply** to save your settings.

Figure 109 Network Setting &gt; Home Networking &gt; LAN Setup

**Home Networking**

LAN Setup | Static DHCP | UPnP

The LAN IP address is the IP address you use to log into the web configurator. The DHCP server settings define the rules on how to assign IP addresses to the LAN clients on your network.

#### LAN IP Setup

IP Address: 192 . 168 . 1 . 1

Subnet Mask: 255 . 255 . 255 . 0

#### DHCP Server State

DHCP:  Enable  Disable  DHCP Relay

#### IP Addressing Values

Beginning IP Address: 192 . 168 . 1 . 2

Ending IP Address: 192 . 168 . 1 . 254

Auto reserve IP for the same host:

#### DHCP Server Lease Time

1 days 0 hours 0 minutes

#### DNS Values

DNS:  DNS Proxy  Static  From ISP

#### LAN IPv6 Mode Setup

IPv6 Active:

#### Link Local Address Type

EUI64  Manual

#### LAN Global Identifier Type

EUI64  Manual

#### LAN IPv6 Prefix Setup

Delegate prefix from WAN: Default  Static

#### LAN IPv6 Address Assign Setup

Stateless

#### LAN IPv6 DNS Assign Setup

From RA & DHCPv6 Server

#### DHCPv6 Configuration

DHCPv6 Active: DHCPv6 Server

#### IPv6 Router Advertisement State

RADVD Active: Enable

#### IPv6 DNS Values

IPv6 DNS Server 1: From ISP

IPv6 DNS Server 2: From ISP

IPv6 DNS Server 3: From ISP

#### DNS Query Scenario

IPv4/IPv6 DNS Server

Cancel Apply

The following table describes the fields in this screen.

Table 51 Network Setting > Home Networking > LAN Setup

LABEL	DESCRIPTION
Interface Group	
Group Name	Select the interface group that you want to configure its LAN settings.
LAN IP Setup	
IP Address	Enter the LAN IP address you want to assign to your Zyxel Device in dotted decimal notation, for example, 192.168.1.1 (factory default).
Subnet Mask	Enter the subnet mask of your network in dotted decimal notation, for example 255.255.255.0 (factory default). Your Zyxel Device automatically computes the subnet mask based on the IP address you enter, so do not change this field unless you are instructed to do so.
DHCP Server State	
DHCP	<p>Select <b>Enable</b> to have your Zyxel Device assign IP addresses, an IP default gateway and DNS servers to LAN computers and other devices that are DHCP clients.</p> <p>If you select <b>Disable</b>, you need to manually configure the IP addresses of the computers and other devices on your LAN.</p> <p>If you select <b>DHCP Relay</b>, the Zyxel Device acts as a surrogate DHCP server and relays DHCP requests and responses between the remote server and the clients.</p>
IP Addressing Values	
The <b>IP Addressing Values</b> fields appear only when you select <b>Enable</b> in the <b>DHCP</b> field.	
Beginning IP Address	This field specifies the first of the contiguous addresses in the IP address pool.
Ending IP Address	This field specifies the last of the contiguous addresses in the IP address pool.
Auto reserve IP for the same host	Enable this if you want to reserve the IP address for the same host.
DHCP Server Lease Time	
<p>This is the period of time DHCP-assigned addresses is used. DHCP automatically assigns IP addresses to clients when they log in. DHCP centralizes IP address management on central computers that run the DHCP server program. DHCP leases addresses, for a period of time, which means that past addresses are "recycled" and made available for future reassignment to other systems.</p> <p>This field is only available when you select <b>Enable</b> in the <b>DHCP</b> field.</p>	
Days/Hours/Minutes	DHCP server leases an address to a new client device for a period of time, called the DHCP lease time. When the lease expires, the DHCP server might assign the IP address to a different client device.
DNS Values	
This field appears only when you select <b>Enable</b> in the <b>DHCP</b> field.	
DNS	<p>The Zyxel Device supports DNS proxy by default. The Zyxel Device sends out its own LAN IP address to the DHCP clients as the first DNS server address. DHCP clients use this first DNS server to send domain-name queries to the Zyxel Device. The Zyxel Device sends a response directly if it has a record of the domain-name to IP address mapping. If it does not, the Zyxel Device queries an outside DNS server and relays the response to the DHCP client.</p> <p>Select <b>DNS Proxy</b> to have the DHCP clients use the Zyxel Device's own LAN IP address. The Zyxel Device works as a DNS relay.</p> <p>Select <b>Static</b> if you have the IP address of a DNS server. Enter the DNS server's IP address in the field to the right.</p> <p>Select <b>From ISP</b> if your ISP dynamically assigns DNS server information (and the Zyxel Device's WAN IP address).</p>



Table 51 Network Setting &gt; Home Networking &gt; LAN Setup (continued)

LABEL	DESCRIPTION						
LAN IPv6 Mode Setup							
IPv6 Active	Use this to enable or disable IPv6 on the Zyxel Device. When IPv6 is used, the following fields need to be set.						
Link Local Address Type	<p>A link-local address uniquely identifies a device on the local network (the LAN). It is similar to a "private IP address" in IPv6. You can have the same link-local address on multiple interfaces on a device. A link-local unicast address has a predefined prefix of fe80::/10. The link-local unicast address format is as follows. Select <b>EUI64</b> to allow the Zyxel Device to generate an interface ID for the LAN interface's link-local address using the EUI-64 format. Otherwise, enter an interface ID for the LAN interface's link-local address if you select <b>Manual</b>.</p> <p>Link-local Unicast Address Format</p> <table border="1" data-bbox="526 642 980 722"> <tr> <td data-bbox="526 642 695 682">1111 1110 10</td> <td data-bbox="695 642 792 682">0</td> <td data-bbox="792 642 980 682">Interface ID</td> </tr> <tr> <td data-bbox="526 682 695 722">10 bits</td> <td data-bbox="695 682 792 722">54 bits</td> <td data-bbox="792 682 980 722">64 bits</td> </tr> </table>	1111 1110 10	0	Interface ID	10 bits	54 bits	64 bits
1111 1110 10	0	Interface ID					
10 bits	54 bits	64 bits					
EUI64	Select this to have the Zyxel Device generate an interface ID for the LAN interface's link-local address using the EUI-64 format.						
Manual	Select this to manually enter an interface ID for the LAN interface's link-local address.						
LAN Global Identifier Type	Select <b>EUI64</b> to have the Zyxel Device generate an interface ID using the EUI-64 format for its global address. Select <b>Manual</b> to manually enter an interface ID for the LAN interface's global IPv6 address.						
EUI64	Select this to have the Zyxel Device generate an interface ID using the EUI-64 format for its global address.						
Manual	Select this to manually enter an interface ID for the LAN interface's global IPv6 address.						
LAN IPv6 Prefix Setup	Select <b>Delegate prefix from WAN</b> to automatically obtain an IPv6 network prefix from the service provider or an uplink router. Select <b>Static</b> to configure a fixed IPv6 address for the Zyxel Device's LAN IPv6 address.						
Delegate prefix from WAN	Select this option to automatically obtain an IPv6 network prefix from the service provider or an uplink router.						
Static	Select this option to configure a fixed IPv6 address for the Zyxel Device's LAN IPv6 address.						
LAN IPv6 Address Assign Setup	<p>Select how you want to obtain an IPv6 address:</p> <p><b>Stateless:</b> The Zyxel Device uses IPv6 stateless auto-configuration. RADVD (Router Advertisement Daemon) is enabled to have the Zyxel Device send IPv6 prefix information in router advertisements periodically and in response to router solicitations. DHCPv6 server is disabled.</p> <p><b>Stateful:</b> The Zyxel Device uses IPv6 stateful auto-configuration. The DHCPv6 server is enabled to have the Zyxel Device act as a DHCPv6 server and pass IPv6 addresses to DHCPv6 clients.</p>						
LAN IPv6 DNS Assign Setup	<p>Select how the Zyxel Device provide DNS server and domain name information to the clients:</p> <p><b>From RA &amp; DHCPv6 Server:</b> The Zyxel Device provides DNS information through both router advertisements and DHCPv6.</p> <p><b>From DHCPv6 Server:</b> The Zyxel Device provides DNS information through DHCPv6.</p> <p><b>From Router Advertisement:</b> The Zyxel Device provides DNS information through router advertisements.</p>						
DHCPv6 Configuration							
DHCPv6 Active	This shows the status of the DHCPv6. <b>DHCP Server</b> displays if you configured the Zyxel Device to act as a DHCPv6 server which assigns IPv6 addresses and/or DNS information to clients.						
IPv6 Router Advertisement State							

Table 51 Network Setting &gt; Home Networking &gt; LAN Setup (continued)

LABEL	DESCRIPTION
RADVD Active	This shows whether RADVD is enabled or not.
IPv6 DNS Values	
IPv6 DNS Server 1 – 3	<p>Specify the IP addresses up to three DNS servers for the DHCP clients to use. Use one of the following ways to specify these IP addresses.</p> <p><b>User Defined</b> – Select this if you have the IPv6 address of a DNS server. Enter the DNS server IPv6 addresses the Zyxel Device passes to the DHCP clients.</p> <p><b>From ISP</b> – Select this if your ISP dynamically assigns IPv6 DNS server information.</p> <p><b>Proxy</b> – Select this if the DHCP clients use the IP address of this interface and the Zyxel Device works as a DNS relay.</p> <p>Otherwise, select <b>None</b> if you do not want to configure IPv6 DNS servers.</p>
DNS Query Scenario	<p>Select how the Zyxel Device handles clients' DNS information requests.</p> <p><b>IPv4/IPv6 DNS Server:</b> The Zyxel Device forwards the requests to both the IPv4 and IPv6 DNS servers and sends clients the first DNS information it receives.</p> <p><b>IPv6 DNS Server Only:</b> The Zyxel Device forwards the requests to the IPv6 DNS server and sends clients the DNS information it receives.</p> <p><b>IPv4 DNS Server Only:</b> The Zyxel Device forwards the requests to the IPv4 DNS server and sends clients the DNS information it receives.</p> <p><b>IPv6 DNS Server First:</b> The Zyxel Device forwards the requests to the IPv6 DNS server first and then the IPv4 DNS server. Then it sends clients the first DNS information it receives.</p> <p><b>IPv4 DNS Server First:</b> The Zyxel Device forwards the requests to the IPv4 DNS server first and then the IPv6 DNS server. Then it sends clients the first DNS information it receives.</p>
Apply	Click <b>Apply</b> to save your changes.
Cancel	Click <b>Cancel</b> to restore your previously saved settings.

## 9.3 Static DHCP

When any of the LAN clients in your network want an assigned fixed IP address, add a static lease for each LAN client. Knowing the LAN client's MAC addresses is necessary. This table allows you to assign IP addresses on the LAN to individual computers based on their MAC addresses.

Every Ethernet device has a unique MAC (Media Access Control) address. The MAC address is assigned at the factory and consists of six pairs of hexadecimal characters, for example, 00:A0:C5:00:00:02.

### 9.3.1 Before You Begin

Find out the MAC addresses of your network devices if you intend to add them to the **Static DHCP** screen.

Use this screen to change your Zyxel Device's static DHCP settings. Click **Network Setting > Home Networking > Static DHCP** to open the following screen.

**Figure 110** Network Setting > Home Networking > Static DHCP

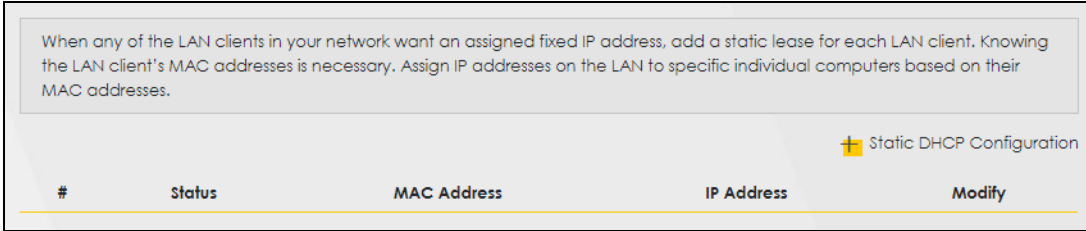

The following table describes the labels in this screen.

**Table 52** Network Setting > Home Networking > Static DHCP

LABEL	DESCRIPTION
Static DHCP Configuration	Click this to configure a static DHCP entry.
#	This is the index number of the entry.
Status	This field displays whether the client is connected to the Zyxel Device.
MAC Address	The MAC (Media Access Control) or Ethernet address on a LAN (Local Area Network) is unique to your computer (six pairs of hexadecimal notation).  A network interface card such as an Ethernet adapter has a hardwired address that is assigned at the factory. This address follows an industry standard that ensures no other adapter has a similar address.
IP Address	This field displays the IP address relative to the # field listed above.
Modify	Click the <b>Edit</b> icon to configure the connection.  Click the <b>Delete</b> icon to remove the connection.

If you click **Static DHCP Configuration** in the **Static DHCP** screen, the following screen displays. Using a static DHCP means a LAN client will always have the same IP address assigned to it by the DHCP server. Assign a fixed IP address to a client device by selecting the interface group of this client device and its IP address type and selecting the device/computer from a list or manually entering its MAC address and assigned IP address.

**Figure 111** Network Setting > Home Networking > Static DHCP: Static DHCP Configuration

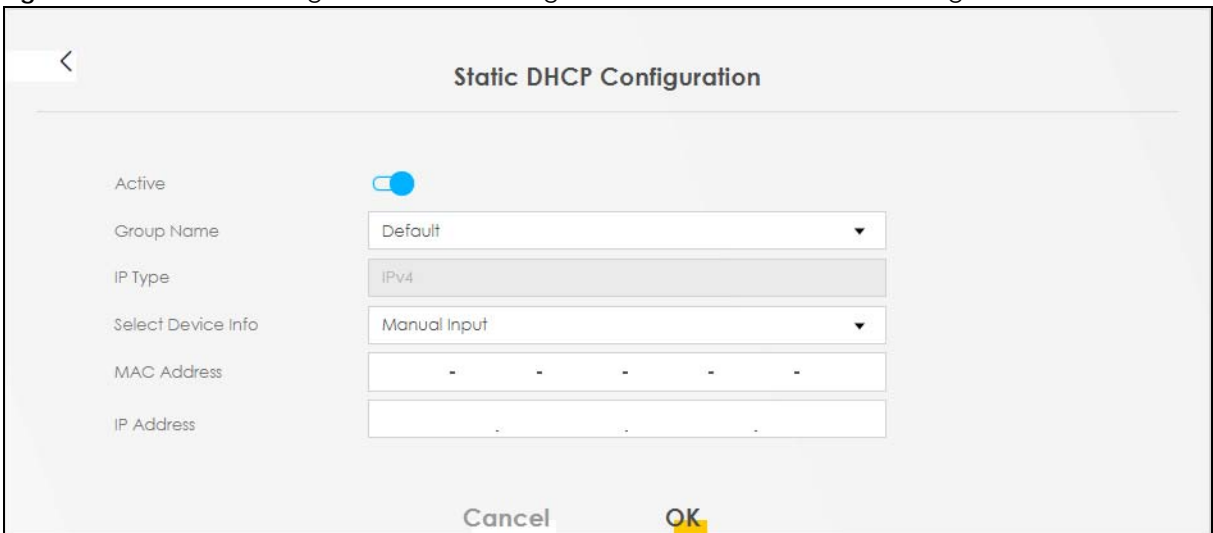

The following table describes the labels in this screen.

Table 53 Network Setting > Home Networking > Static DHCP: Static DHCP Configuration

LABEL	DESCRIPTION
Active	Select <b>Enable</b> to activate static DHCP in your Zyxel Device.
Group Name	Select the interface group for which you want to configure the static DHCP settings.
IP Type	The <b>IP Type</b> is normally <b>IPv4</b> (non-configurable).
Select Device Info	Select between <b>Manual Input</b> which allows you to enter the next two fields ( <b>MAC Address</b> and <b>IP Address</b> ); or select an existing LAN device to show its MAC address and IP address.
MAC Address	Enter the MAC address of a computer on your LAN if you select <b>Manual Input</b> in the previous field.
IP Address	Enter the IP address that you want to assign to the computer on your LAN with the MAC address that you will also specify if you select <b>Manual Input</b> in the previous field.
OK	Click <b>OK</b> to save your changes.
Cancel	Click <b>Cancel</b> to exit this screen without saving.

## 9.4 UPnP

Universal Plug and Play (UPnP) is an open networking standard that uses TCP/IP for simple peer-to-peer network connectivity between networking devices or software applications which have UPnP enabled. A UPnP device can dynamically join a network, obtain an IP address, advertise its services, and learn about other devices on the network. A device can also leave a network automatically when it is no longer in use.

See [Section 9.6 on page 184](#) for more information on UPnP.

Note: To use **UPnP NAT-T**, enable **NAT** in the **Network Setting > Broadband > Edit or Add New WAN Interface** screen.

Use the following screen to configure the UPnP settings on your Zyxel Device. Click **Network Setting > Home Networking > UPnP** to display the screen shown next.

**Figure 112** Network Setting > Home Networking > UPnP

Universal Plug and Play (UPnP) is an open networking standard that uses TCP/IP for simple peer-to-peer network connectivity between networking devices or software applications which have UPnP enabled. A UPnP device can dynamically join a network, obtain an IP address, advertise its services, and learn about other devices on the network. A device can also leave a network automatically when it is no longer in use.

**UPnP State**

UPnP

**UPnP NAT-T State**

UPnP NAT-T

Note  
To use **UPnP NAT-T**, enable **NAT** in the **Network Setting > Broadband > Edit/Add New WAN Interface** screen.

#	Description	Destination IP Address	External Port	Internal Port	Protocol
<input type="button" value="Cancel"/> <input type="button" value="Apply"/>					

The following table describes the labels in this screen.

**Table 54** Network Settings > Home Networking > UPnP

LABEL	DESCRIPTION
UPnP State	
UPnP	Select <b>Enable</b> to activate UPnP. Be aware that anyone could use a UPnP application to open the Web Configurator's login screen without entering the Zyxel Device's IP address (although you must still enter the password to access the Web Configurator).
UPnP NAT-T State	
UPnP NAT-T	Select <b>Enable</b> to activate UPnP with NAT enabled. UPnP NAT traversal automates the process of allowing an application to operate through NAT. UPnP network devices can automatically configure network addressing, announce their presence in the network to other UPnP devices and enable exchange of simple product and service descriptions.
#	This field displays the index number of the entry.
Description	This field displays the description of the UPnP NAT-T connection.
Destination IP Address	This field displays the IP address of the other connected UPnP-enabled device.
External Port	This field displays the external port number that identifies the service.
Internal Port	This field displays the internal port number that identifies the service.
Protocol	This field displays the protocol of the NAT mapping rule. Choices are <b>TCP</b> or <b>UDP</b> .
Apply	Click <b>Apply</b> to save your changes.
Cancel	Click <b>Cancel</b> to restore your previously saved settings.

## 9.5 Technical Reference

This section provides some technical background information about the topics covered in this chapter.

## LANs, WANs and the Zyxel Device

The actual physical connection determines whether the Zyxel Device ports are LAN or WAN ports. There are two separate IP networks, one inside the LAN network and the other outside the WAN network as shown next.

**Figure 113** LAN and WAN IP Addresses

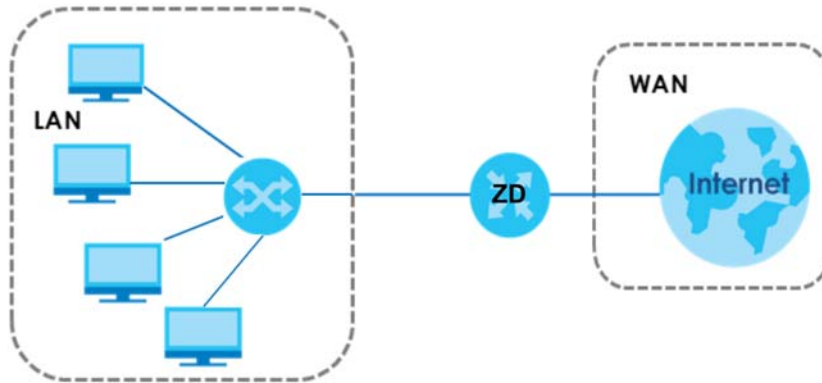

### 9.5.1 DHCP Setup

DHCP (Dynamic Host Configuration Protocol, RFC 2131 and RFC 2132) allows individual clients to obtain TCP/IP configuration at start-up from a server. You can configure the Zyxel Device as a DHCP server or disable it. When configured as a server, the Zyxel Device provides the TCP/IP configuration for the clients. If you turn DHCP service off, you must have another DHCP server on your LAN, or else the computer must be manually configured.

#### IP Pool Setup

The Zyxel Device is pre-configured with a pool of IP addresses for the DHCP clients (DHCP Pool). See the product specifications in the appendices. Do not assign static IP addresses from the DHCP pool to your LAN computers.

### 9.5.2 DNS Server Addresses

DNS (Domain Name System) maps a domain name to its corresponding IP address and vice versa. The DNS server is extremely important because without it, you must know the IP address of a computer before you can access it. The DNS server addresses you enter when you set up DHCP are passed to the client machines along with the assigned IP address and subnet mask.

There are two ways that an ISP disseminates the DNS server addresses.

- The ISP tells you the DNS server addresses, usually in the form of an information sheet, when you sign up. If your ISP gives you DNS server addresses, enter them in the **DNS Server** fields in the **DHCP Setup** screen.

- Some ISPs choose to disseminate the DNS server addresses using the DNS server extensions of IPCP (IP Control Protocol) after the connection is up. If your ISP did not give you explicit DNS servers, chances are the DNS servers are conveyed through IPCP negotiation. The Zyxel Device supports the IPCP DNS server extensions through the DNS proxy feature.

Please note that DNS proxy works only when the ISP uses the IPCP DNS server extensions. It does not mean you can leave the DNS servers out of the DHCP setup under all circumstances. If your ISP gives you explicit DNS servers, make sure that you enter their IP addresses in the **DHCP Setup** screen.

### 9.5.3 LAN TCP/IP

The Zyxel Device has built-in DHCP server capability that assigns IP addresses and DNS servers to systems that support DHCP client capability.

#### IP Address and Subnet Mask

Similar to the way houses on a street share a common street name, so too do computers on a LAN share one common network number.

Where you obtain your network number depends on your particular situation. If the ISP or your network administrator assigns you a block of registered IP addresses, follow their instructions in selecting the IP addresses and the subnet mask.

If the ISP did not explicitly give you an IP network number, then most likely you have a single user account and the ISP will assign you a dynamic IP address when the connection is established. If this is the case, it is recommended that you select a network number from 192.168.0.0 to 192.168.255.0 and you must enable the Network Address Translation (NAT) feature of the Zyxel Device. The Internet Assigned Number Authority (IANA) reserved this block of addresses specifically for private use; please do not use any other number unless you are told otherwise. Let's say you select 192.168.1.0 as the network number; which covers 254 individual addresses, from 192.168.1.1 to 192.168.1.254 (zero and 255 are reserved). In other words, the first three numbers specify the network number while the last number identifies an individual computer on that network.

Once you have decided on the network number, pick an IP address that is easy to remember, for instance, 192.168.1.1, for your Zyxel Device, but make sure that no other device on your network is using that IP address.

The subnet mask specifies the network number portion of an IP address. Your Zyxel Device will compute the subnet mask automatically based on the IP address that you entered. You do not need to change the subnet mask computed by the Zyxel Device unless you are instructed to do otherwise.

#### Private IP Addresses

Every machine on the Internet must have a unique address. If your networks are isolated from the Internet, for example, only between your two branch offices, you can assign any IP addresses to the hosts without problems. However, the Internet Assigned Numbers Authority (IANA) has reserved the following three blocks of IP addresses specifically for private networks:

- 10.0.0.0 — 10.255.255.255
- 172.16.0.0 — 172.31.255.255
- 192.168.0.0 — 192.168.255.255

You can obtain your IP address from the IANA, from an ISP or it can be assigned from a private network. If you belong to a small organization and your Internet access is through an ISP, the ISP can provide you with the Internet addresses for your local networks. On the other hand, if you are part of a much larger organization, you should consult your network administrator for the appropriate IP addresses.

Note: Regardless of your particular situation, do not create an arbitrary IP address; always follow the guidelines above. For more information on address assignment, please refer to RFC 1597, "Address Allocation for Private Internets" and RFC 1466, "Guidelines for Management of IP Address Space".

## 9.6 Turn on UPnP in Windows 10 Example

This section shows you how to use the UPnP feature in Windows 10. UPnP server is installed in Windows 10. Activate UPnP on the Zyxel Device by clicking **Network Setting > Home Networking > UPnP**.

Make sure the computer is connected to the LAN port of the Zyxel Device. Turn on your computer and the Zyxel Device.

- 1 Click the start icon, **Settings** and then **Network & Internet**.

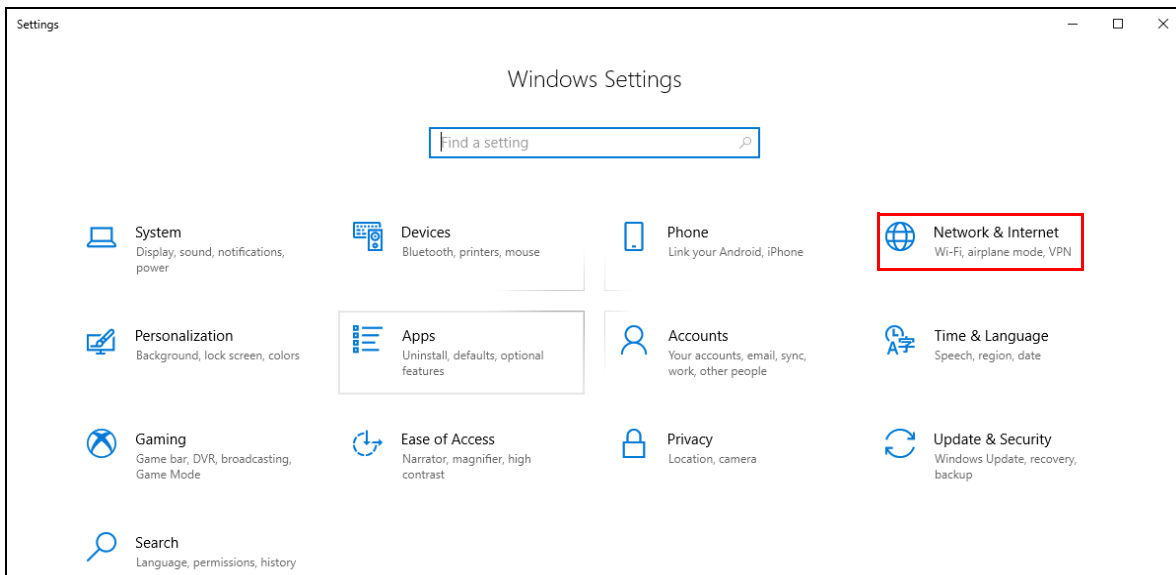

- 2 Click **Network and Sharing Center**.



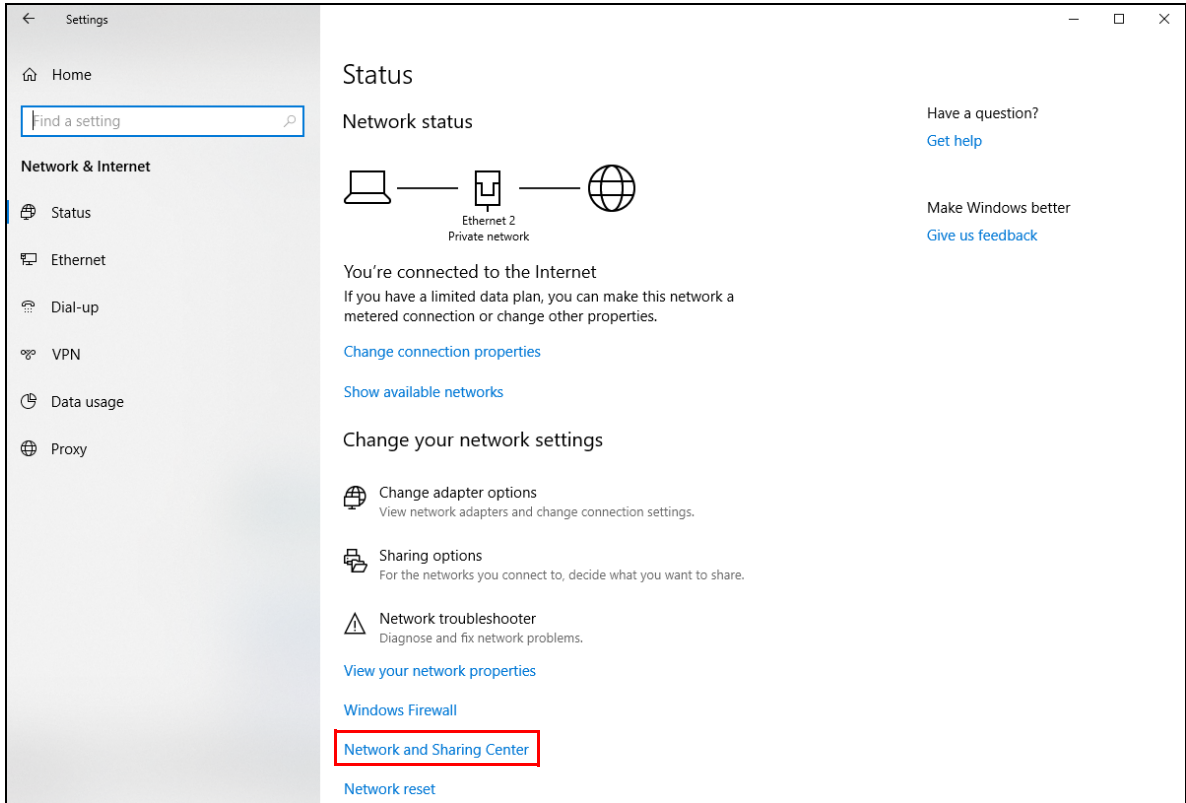

**3** Click **Change advanced sharing settings**.

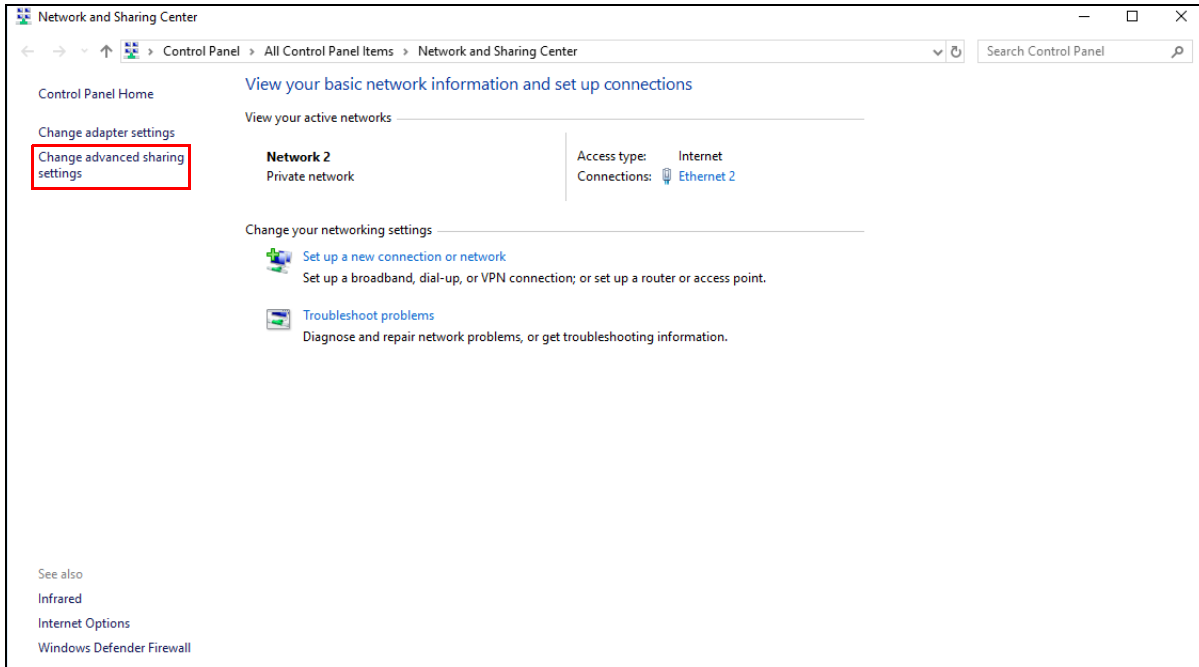

**4** Under **Domain**, select **Turn on network discovery** and click **Save Changes**. Network discovery allows your computer to find other computers and devices on the network and other computers on the network to find your computer. This makes it easier to share files and printers.

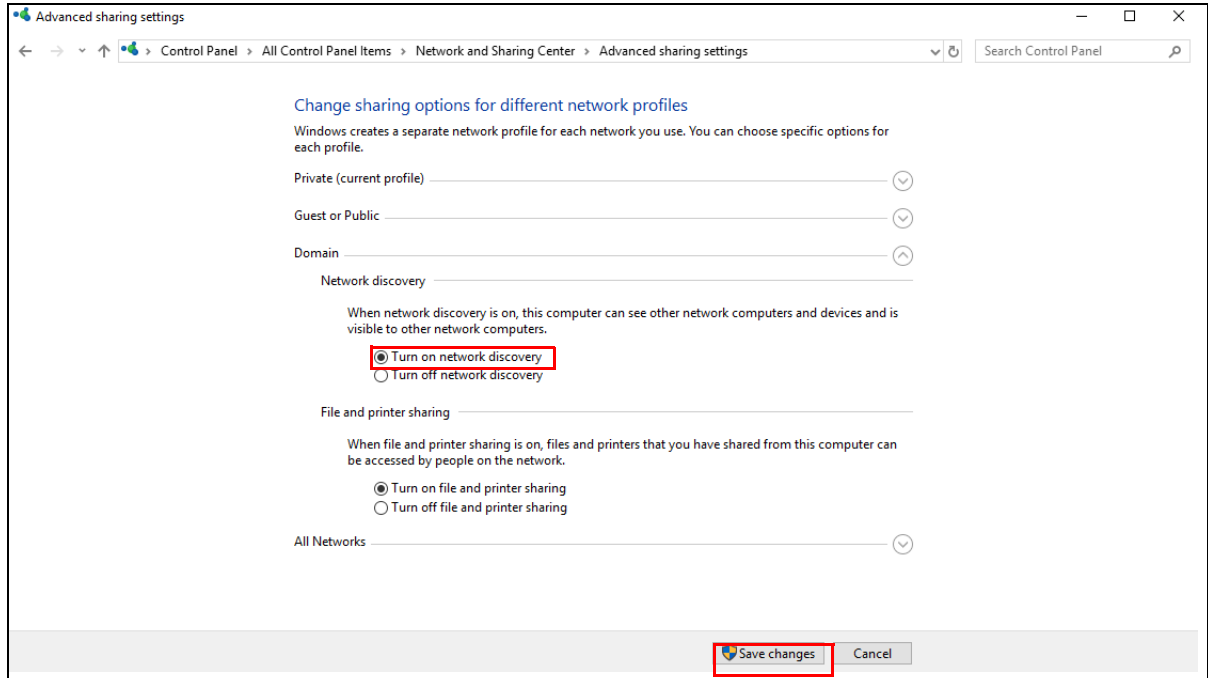

## 9.6.1 Auto-discover Your UPnP-enabled Network Device

Before you follow these steps, make sure you already have UPnP activated on the Zyxel Device and in your computer.

Make sure your computer is connected to the LAN port of the Zyxel Device.

- 1 Open **File Explorer** and click **Network**.
- 2 Right-click the Zyxel Device icon and select **Properties**.

Figure 114 Network Connections

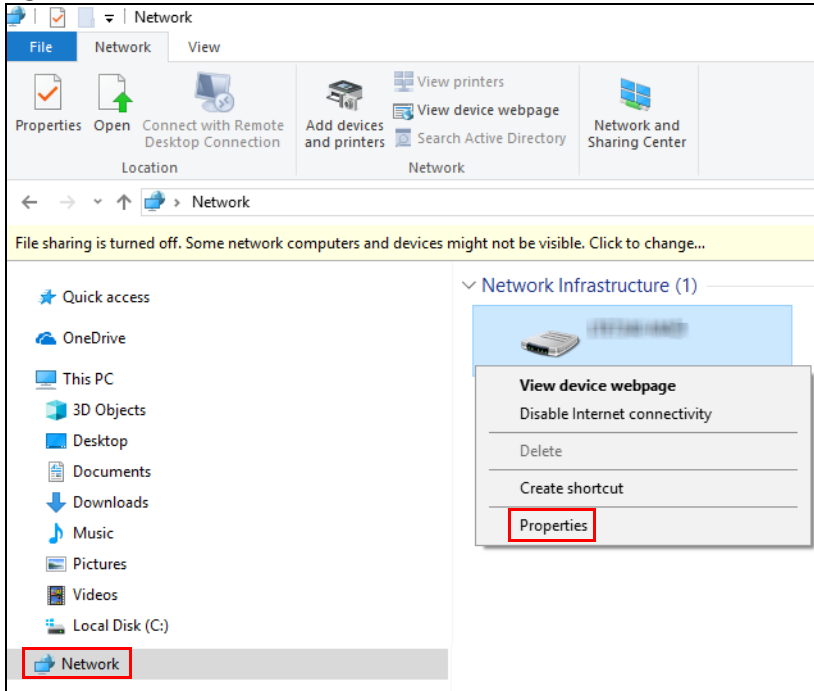

- 3 In the **Internet Connection Properties** window, click **Settings** to see port mappings.

Figure 115 Internet Connection Properties

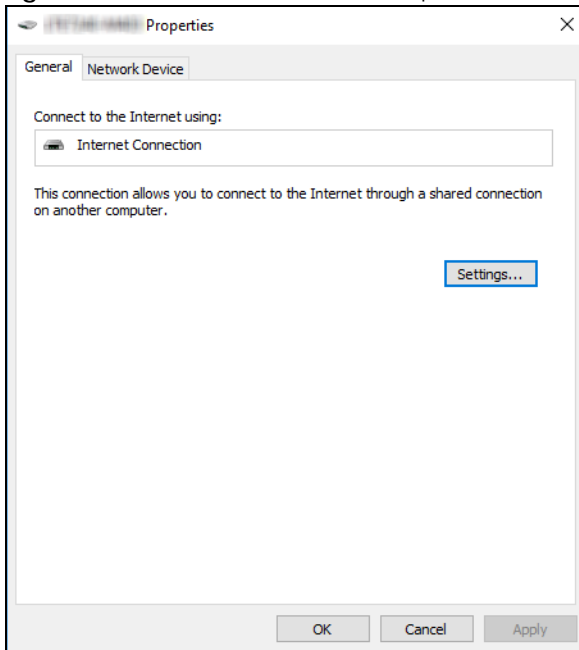

- 4 You may edit or delete the port mappings or click **Add** to manually add port mappings.

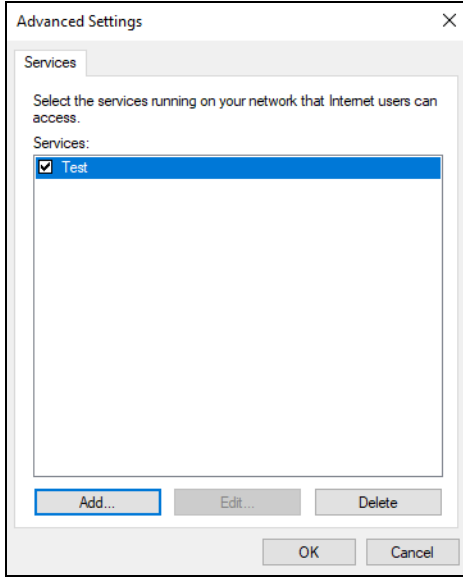
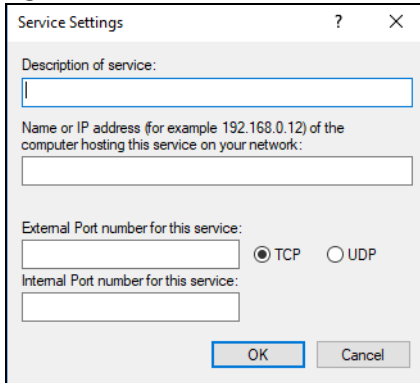
**Figure 116** Internet Connection Properties: Advanced Settings**Figure 117** Internet Connection Properties: Advanced Settings: Add

Note: When the UPnP-enabled device is disconnected from your computer, all port mappings will be deleted automatically.

- 5 Click **OK**. Check the network icon on the system tray to see your Internet connection status.

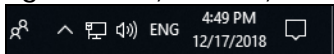
**Figure 118** System Tray Icon

- 6 To see more details about your current Internet connection status, right click the network icon in the system tray and click **Open Network & Internet settings**. Click **Network and Sharing Center** and click the **Connections**.

Figure 119 Internet Connection Status

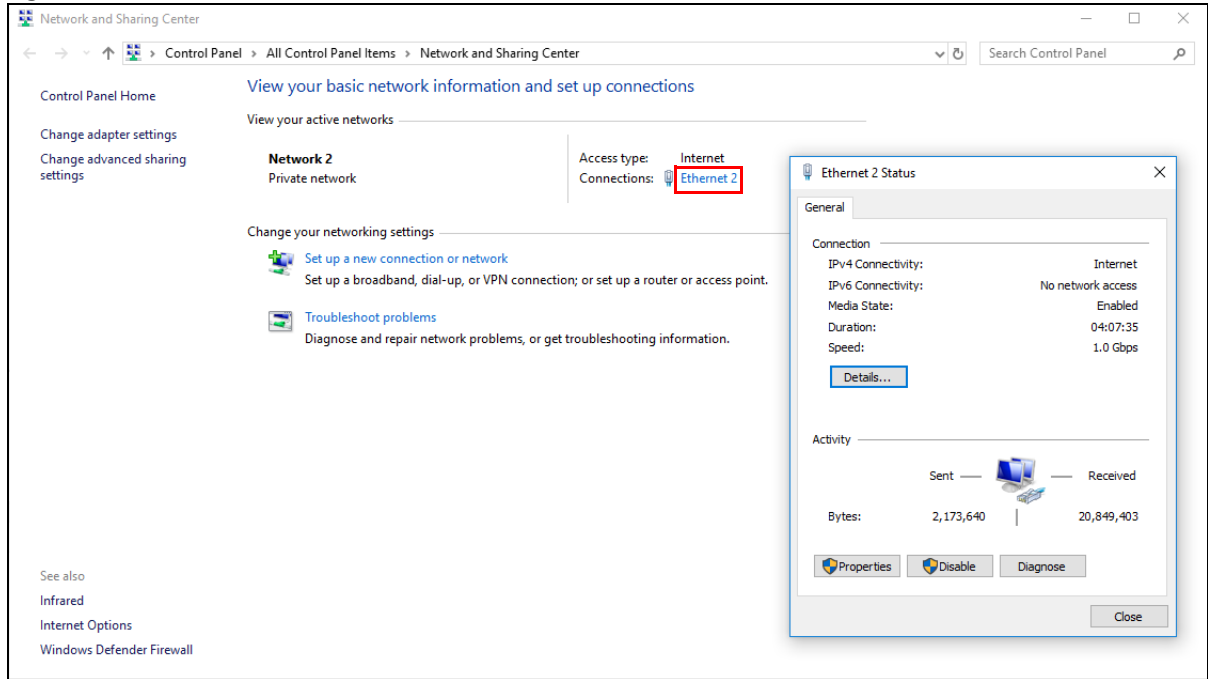

## 9.7 Web Configurator Access with UPnP in Windows 10

Follow the steps below to access the Web Configurator.

- 1 Open **File Explorer**.
- 2 Click **Network**.

Figure 120 Network Connections

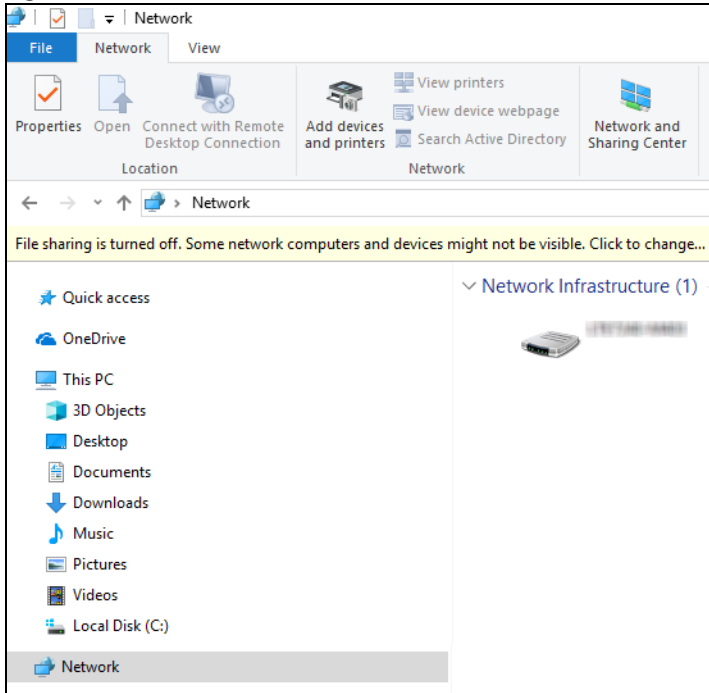

- 3 An icon with the description for each UPnP-enabled device displays under **Network Infrastructure**.
- 4 Right-click the icon for your Zyxel Device and select **View device webpage**. The Web Configurator login screen displays.

Figure 121 Network Connections: Network Infrastructure

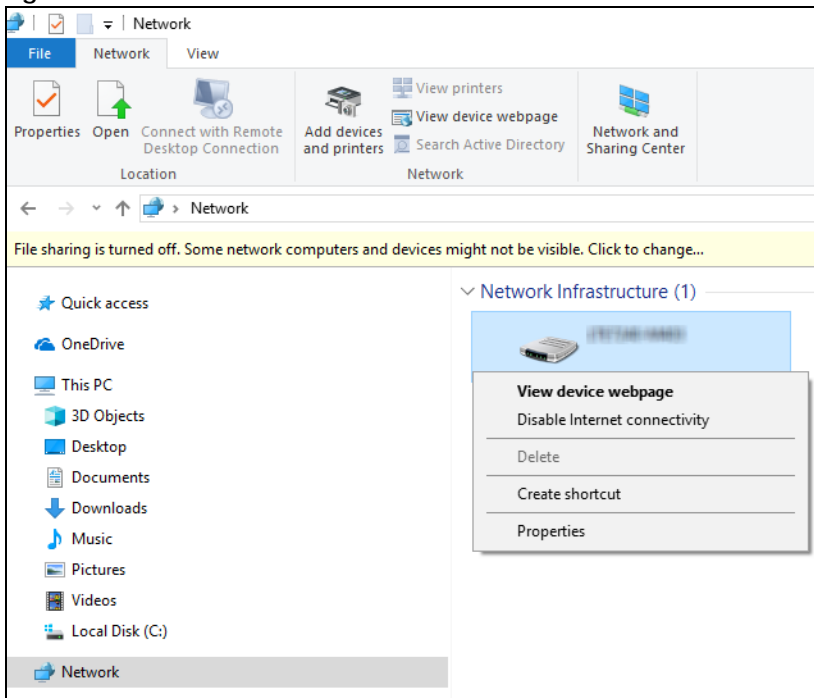

- 5 Right-click the icon for your Zyxel Device and select **Properties**. Click the **Network Device** tab. A window displays information about the Zyxel Device.

Figure 122 Network Connections: Network Infrastructure: Properties: Example

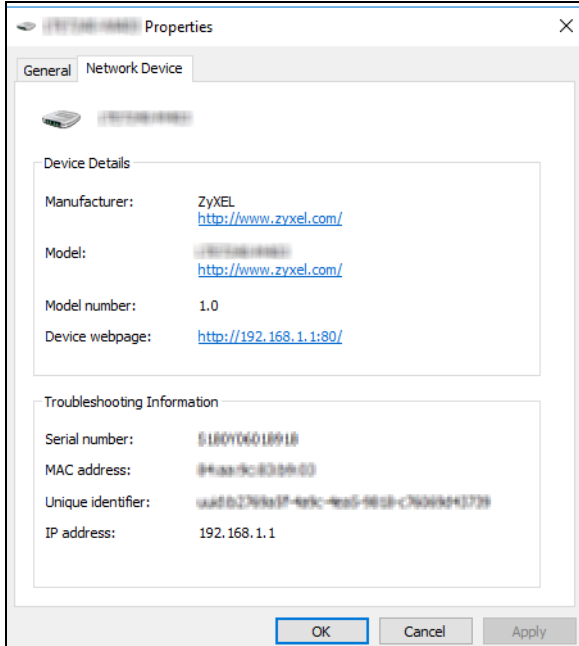

# CHAPTER 10

## Routing

### 10.1 Routing Overview

The Zyxel Device usually uses the default gateway to route outbound traffic from computers on the LAN to the Internet. To have the Zyxel Device send data to devices not reachable through the default gateway, use static routes.

For example, the next figure shows a computer (**A**) connected to the Zyxel Device's LAN interface. The Zyxel Device routes most traffic from **A** to the Internet through the Zyxel Device's default gateway (**R1**). You create one static route to connect to services offered by your ISP behind router **R2**. You create another static route to communicate with a separate network behind a router **R3** connected to the LAN.

**Figure 123** Example of Static Routing Topology

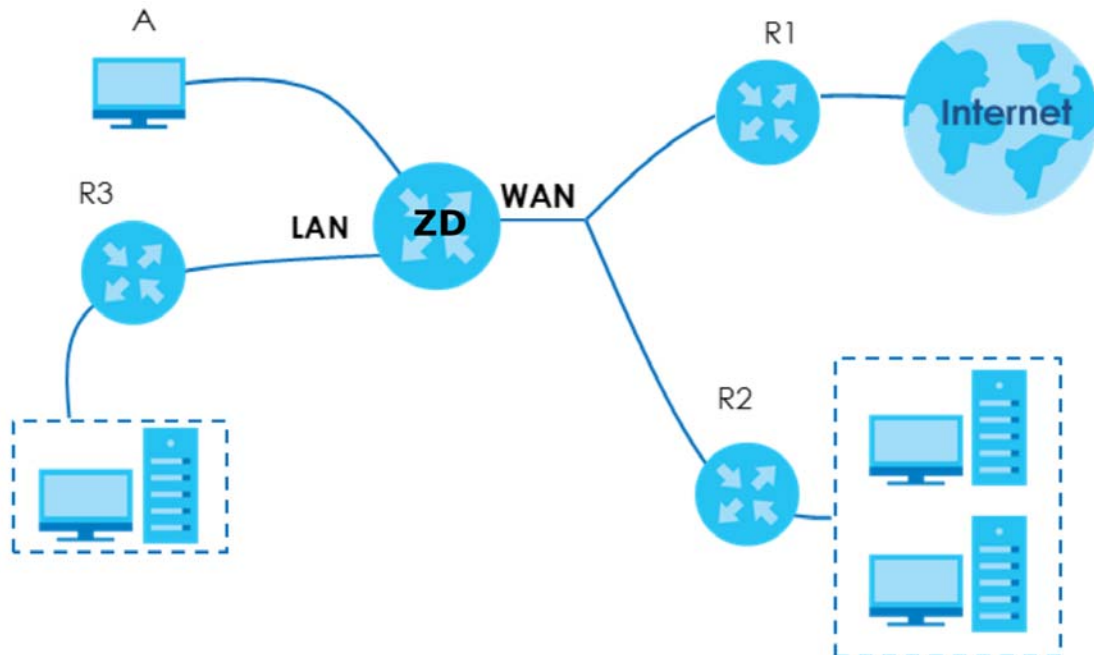

### 10.2 Configure Static Route

Use this screen to view and configure static route rules on the Zyxel Device. A static route is used to save time and bandwidth usage when LAN devices within an Intranet are transferring files or packets, especially when there are more than two Internet connections in your home or office network. Click **Network Setting > Routing** to open the **Static Route** screen.

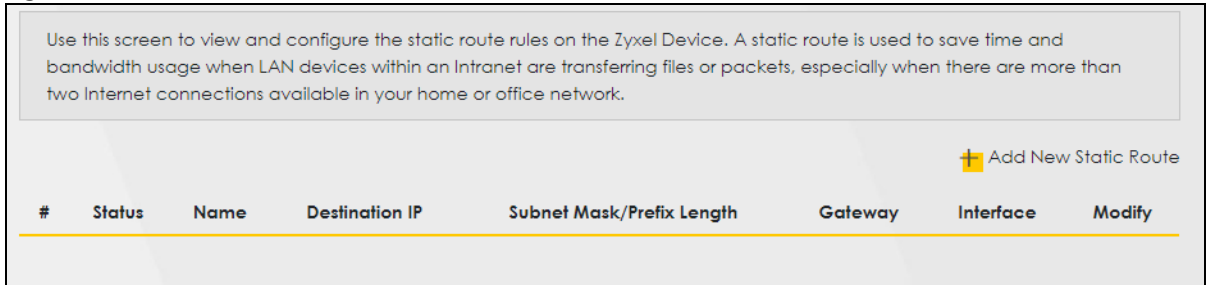

**Figure 124** Network Setting > Routing > Static Route

The following table describes the labels in this screen.

**Table 55** Network Setting > Routing > Static Route

LABEL	DESCRIPTION
Add New Static Route	Click this to set up a new static route on the Zyxel Device.
#	This is the number of an individual static route.
Status	This field indicates whether the rule is active (yellow bulb) or not (gray bulb).
Name	This is the name of the static route.
Destination IP	This parameter specifies the IP network address of the final destination. Routing is always based on network number.
Subnet Mask/Prefix Length	This parameter specifies the IP network subnet mask of the final destination.
Gateway	This is the IP address of the gateway. The gateway is a router or switch on the same network segment as the device's LAN or WAN port. The gateway helps forward packets to their destinations.
Interface	This is the WAN interface through which the traffic is routed.
Modify	Click the <b>Edit</b> icon to go to the screen where you can set up a static route on the Zyxel Device. Click the <b>Delete</b> icon to remove a static route from the Zyxel Device.

## 10.2.1 Add or Edit Static Route

Use this screen to add or edit a static route. Click **Add New Static Route** in the **Static Route** screen, the following screen appears. Configure the required information for a static route.

Note: The **Gateway IP Address** must be within the range of the selected interface in **Use Interface**.

Figure 125 Network Setting &gt; Routing &gt; Static Route &gt; Add New Static Route

The following table describes the labels in this screen.

Table 56 Network Setting &gt; Routing &gt; Static Route &gt; Add New Static Route

LABEL	DESCRIPTION
Active	Click this switch to activate static route. Otherwise, click to disable.
Route Name	Enter a name for your static route. You can use up to 15 printable characters except [ " ], [ ` ], [ ' ], [ < ], [ > ], [ ^ ], [ \$ ], [   ], [ & ], or [ : ]. Spaces are allowed.
IP Type	Select between <b>IPv4</b> or <b>IPv6</b> . Compared to <b>IPv4</b> , <b>IPv6</b> (Internet Protocol version 6), is designed to enhance IP address size and features. The increase in <b>IPv6</b> address size to 128 bits (from the 32-bit <b>IPv4</b> address) allows up to 3.4 x 10 <sup>38</sup> IP addresses. The Zyxel Device can use <b>IPv4/IPv6</b> dual stack to connect to <b>IPv4</b> and <b>IPv6</b> networks, and supports <b>IPv6</b> rapid deployment (6RD).
Destination IP Address	This parameter specifies the IP network address of the final destination. Routing is always based on network number. If you need to specify a route to a single host, use a subnet mask of 255.255.255.255 in the subnet mask field to force the network number to be identical to the host ID.
Subnet Mask	If you are using IPv4 and need to specify a route to a single host, use a subnet mask of 255.255.255.255 in the subnet mask field to force the network number to be identical to the host ID. Enter the IP subnet mask here.  Note: This field appears only when you select <b>IPv4</b> in the <b>IP Type</b> field.
Prefix Length	If you are using IPv6, enter the address prefix length to specify how many most significant bits in an IPv6 address compose the network address.  Note: This field appears only when you select <b>IPv6</b> in the <b>IP Type</b> field.
Use Gateway IP Address	The gateway is a router or switch on the same network segment as the device's LAN or WAN port. The gateway helps forward packets to their destinations.  Click this switch to enable or disable the gateway IP address. When the switch goes to the right, the function is enabled. Otherwise, it is not.

Table 56 (continued) Network Setting &gt; Routing &gt; Static Route &gt; Add New Static Route

LABEL	DESCRIPTION
User Interface	You can decide if you want to forward packets to a gateway IP address ( <b>Default</b> ) or a bound interface ( <b>Cellular WAN</b> ).  If you want to configure bound interface, choose an interface through which the traffic is sent. You must have the WAN interfaces already configured in the <b>Broadband</b> screen.
OK	Click this to save your changes.
Cancel	Click this to exit this screen without saving.

### 10.2.1.1 An Example of Adding a Static Route

In order to extend your Intranet and control traffic flowing directions, you may connect a router to the Zyxel Device's LAN. The router may be used to separate two department networks. This tutorial shows how to configure a static routing rule for two network routings.

In the following figure, router **R** is connected to the Zyxel Device's LAN. **R** connects to two networks, **N1** (192.168.1.x/24) and **N2** (192.168.10.x/24). If you want to send traffic from computer **A** (in **N1** network) to computer **B** (in **N2** network), the traffic is sent to the Zyxel Device's WAN default gateway by default. In this case, **B** will never receive the traffic.

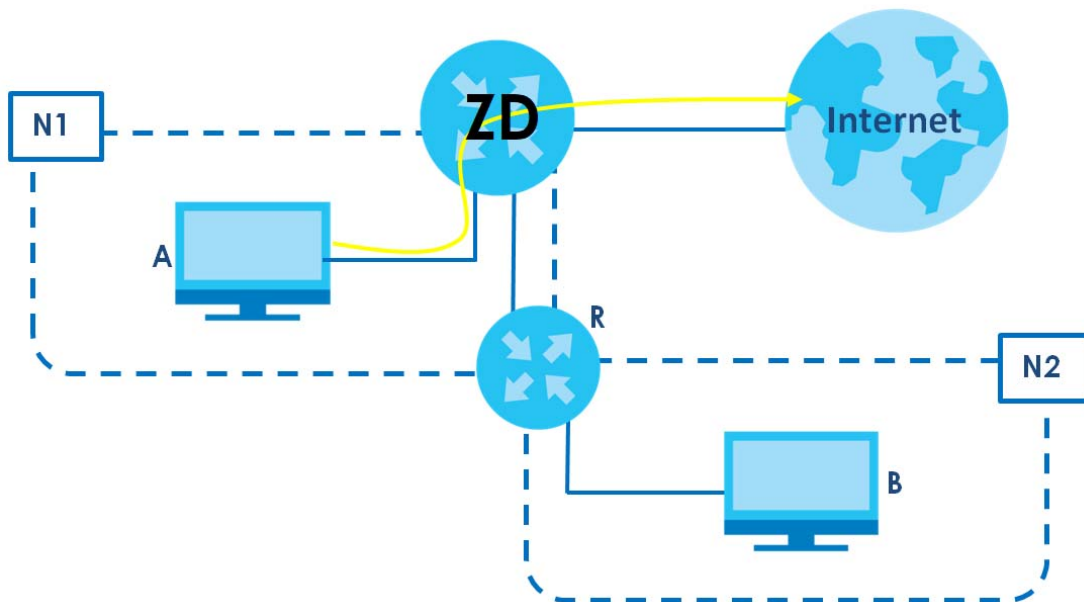

You need to specify a static routing rule on the Zyxel Device to specify **R** as the router in charge of forwarding traffic to **N2**. In this case, the Zyxel Device routes traffic from **A** to **R** and then **R** routes the traffic to **B**.

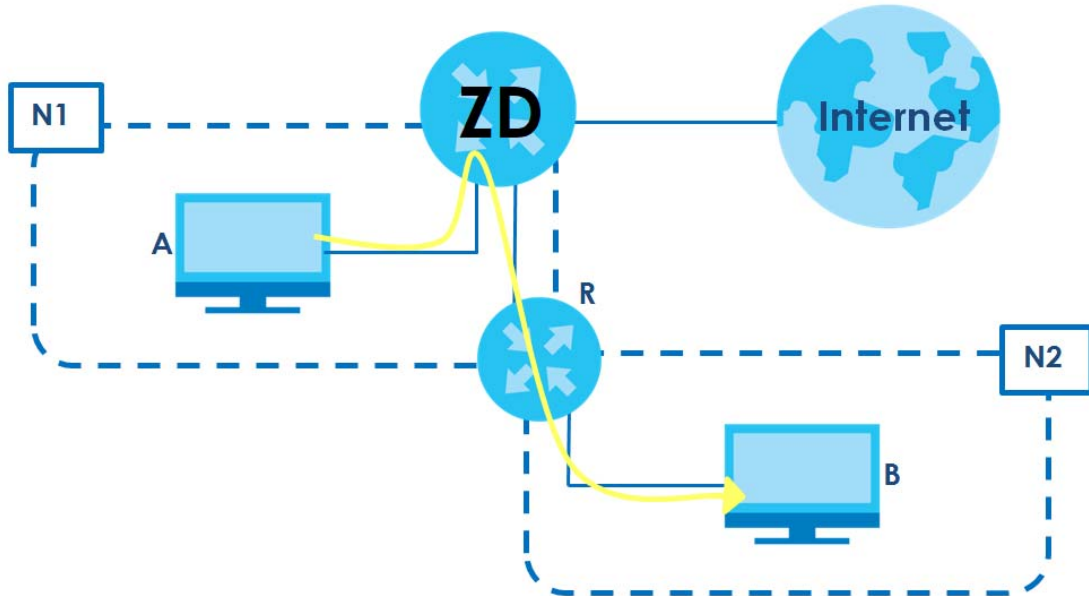

This tutorial uses the following example IP settings:

Table 57 IP Settings in this Tutorial

DEVICE / COMPUTER	IP ADDRESS
The Zyxel Device's WAN	172.16.1.1
The Zyxel Device's LAN	192.168.1.1
IP Type	IPv4
Use Interface	Default
A	192.168.1.34
R's N1	192.168.1.253
R's N2	192.168.10.2
B	192.168.10.33

To configure a static route to route traffic from **N1** to **N2**:

- 1 Log into the Zyxel Device's Web Configurator.
- 2 Click **Network Setting > Routing**.
- 3 Click **Add new Static Route** in the **Static Route** screen.

The purpose of a Static Route is to save time and bandwidth usage when LAN devices within an Intranet are transferring files or packets, especially when there are more than two Internet connections available in your home or office network.

+ Add New Static Route

#	Status	Name	Destination IP	Subnet Mask/Prefix Length	Gateway	Interface	Modify

- 4 Configure the **Static Route Setup** screen using the following settings:
  - Click the **Active** button to enable this static route. When the switch goes to the right, the function is enabled. Enter the **Route Name** as **R**.

- Set **IP Type** to **IPv4**.
- Enter the **Destination IP Address 192.168.10.1** and **IP Subnet Mask 255.255.255.0** for the destination, **N2**.
- Click the **Use Gateway IP Address** button to enable this function. When the switch goes to the right, the function is enabled. Enter **192.168.1.253** (R's N1 address) in the **Gateway IP Address** field.
- Select **Default** as the **Use Interface**.
- Click **OK**.

Now **B** should be able to receive traffic from **A**. You may need to additionally configure **B**'s firewall settings to allow specific traffic to pass through.

**Add New Static Route**

Configure the required information for a static route.

Active

Route Name

IP Type

Destination IP Address

Subnet Mask

Use Gateway IP Address

Gateway IP Address

Use Interface

**Note**  
The input range of the Gateway IP Address must be in the same range of the Use Interface.

**Cancel** **OK**

## 10.3 DNS Route

Use this screen to view and configure DNS routes on the Zyxel Device. A DNS route entry defines a policy for the Zyxel Device to forward a particular DNS query to a specific WAN interface. Click **Network Setting** > **Routing** > **DNS Route** to open the **DNS Route** screen.

**Figure 126** Network Setting > Routing > DNS Route

Use this screen to view and configure DNS routes on the Zyxel Device. A DNS route entry defines a policy for the Zyxel Device to forward a particular DNS query to a specific WAN interface.

 Add New DNS Route

#	Status	Domain Name	WAN Interface	Subnet Mask	Modify

Note  
Maximum of 20 entries can be added.

The following table describes the labels in this screen.

**Table 58** Network Setting > Routing > DNS Route

LABEL	DESCRIPTION
Add New DNS Route	Click this to create a new entry.
#	This is the number of an individual DNS route.
Status	This field indicates whether the rule is active (yellow bulb) or not (gray bulb).
Domain Name	This is the domain name to which the DNS route applies.
WAN Interface	This is the WAN interface through which the matched DNS request is routed.
Subnet Mask	This parameter specifies the IP network subnet mask.
Modify	Click the <b>Edit</b> icon to configure a DNS route on the Zyxel Device. Click the <b>Delete</b> icon to remove a DNS route from the Zyxel Device.

### 10.3.1 Add or Edit DNS Route

You can manually add the Zyxel Device's DNS route entry. Click **Add New DNS Route** in the **DNS Route** screen, use this screen to configure the required information for a DNS route.

**Figure 127** Network Setting > Routing > DNS Route > Add New DNS Route

**Add New DNS Route**

Active

Domain Name

Subnet Mask

WAN Interface

Cancel OK

The following table describes the labels in this screen.

Table 59 Network Setting > Routing > DNS Route > Add New DNS Route

LABEL	DESCRIPTION
Active	Enable DNS route in your Zyxel Device.
Domain Name	Enter the domain name you want to resolve. You can use up to 64 alphanumeric (0-9, a-z, A-Z) characters with hyphens [ - ] and periods [ . ].  You can use the wildcard character, an "*" (asterisk) as the left most part of a domain name, such as *.example.com. The Zyxel Device forwards DNS queries for any domain name ending in example.com to the WAN interface specified in this route.
Subnet Mask	Enter the subnet mask of the network for which to use the DNS route in dotted decimal notation, for example 255.255.255.255.
WAN Interface	Select a WAN interface through which the matched DNS query is sent. You must have the WAN interfaces already configured in the <b>Broadband</b> screen.
OK	Click this to save your changes.
Cancel	Click this to exit this screen without saving.

## 10.4 Policy Route

By default, the Zyxel Device routes packets based on the shortest path to the destination address. Policy routes allow you to override the default behavior and route packets based on other criteria, such as the source address. For example, you can use policy-based routing to direct traffic from specific users through specific connections or distribute traffic across multiple paths for load sharing. Policy-based routing is applied to outgoing packets before the default routing rules are applied.

The **Policy Route** screen let you view and configure routing policies on the Zyxel Device. Click **Network Setting > Routing > Policy Route** to open the following screen.

Figure 128 Network Setting > Routing > Policy Route

#	Status	Name	Source IP	Source Subnet Mask	Protocol	Source Port	Source MAC	Source Interface	WAN Interface	Modify
---	--------	------	-----------	--------------------	----------	-------------	------------	------------------	---------------	--------

The following table describes the labels in this screen.

Table 60 Network Setting > Routing > Policy Route

LABEL	DESCRIPTION
Add New Policy Route	Click this to create a new policy forwarding rule.
#	This is the index number of the entry.
Status	This field displays whether the DNS route is active or not. A yellow bulb signifies that this DNS route is active. A gray bulb signifies that this DNS route is not active.

Table 60 Network Setting &gt; Routing &gt; Policy Route (continued)

LABEL	DESCRIPTION
Name	This is the name of the rule.
Source IP	This is the source IP address.
Source Subnet Mask	This is the source subnet mask address.
Protocol	This is the transport layer protocol.
Source Port	This is the source port number.
Source MAC	This is the source MAC address.
Source Interface	This is the interface from which the matched traffic is sent.
WAN Interface	This is the WAN interface through which the traffic is routed.
Modify	Click the <b>Edit</b> icon to edit this policy.  Click the <b>Delete</b> icon to remove a policy from the Zyxel Device. A window displays asking you to confirm that you want to delete the policy.

### 10.4.1 Add or Edit Policy Route

Click **Add New Policy Route** in the **Policy Route** screen or click the **Edit** icon next to a policy. Use this screen to configure the required information for a policy route.

Figure 129 Network Setting &gt; Routing &gt; Policy Route: Add or Edit

The screenshot shows the 'Add New Policy Route' configuration screen. It includes the following fields and controls:

- Active:** A toggle switch that is currently turned on (blue).
- Route Name:** A text input field.
- Source IP Address:** A text input field with a dotted separator.
- Source Subnet Mask:** A text input field with a dotted separator.
- Protocol:** A dropdown menu currently set to 'None'.
- Source Port:** A text input field with the value '0'.
- Source MAC:** A text input field with a dashed separator.
- Source Interface (ex: br0 or LAN1~LAN4):** A text input field.
- WAN Interface:** A dropdown menu currently set to 'Cellular WAN'.
- Buttons:** 'Cancel' and 'OK' buttons at the bottom.

The following table describes the labels in this screen.

Table 61 Network Setting &gt; Routing &gt; Policy Route: Add or Edit

LABEL	DESCRIPTION
Active	Click this switch to activate this policy route. Otherwise, click to disable.
Route Name	Enter a descriptive name of this policy route. You can use up to 15 printable characters except [ " ], [ ` ], [ ' ], [ < ], [ > ], [ ^ ], [ \$ ], [   ], [ & ], or [ ; ]. Spaces are allowed.



Table 61 Network Setting &gt; Routing &gt; Policy Route: Add or Edit (continued)

LABEL	DESCRIPTION
Source IP Address	Enter the source IP address.
Source Subnet Mask	Enter the source subnet mask address.
Protocol	Select the transport layer protocol ( <b>TCP, UDP, or None</b> ).
Source Port	Enter the source port number.
Source MAC	Enter the source MAC address.
Source Interface (example: br0 or LAN1 – LAN4)	Enter the name of the interface from which the matched traffic is sent.
WAN Interface	Select a WAN interface through which the traffic is sent. You must have the WAN interfaces already configured in the <b>Broadband</b> screens.
Cancel	Click <b>Cancel</b> to exit this screen without saving.
OK	Click <b>OK</b> to save your changes.

## 10.5 RIP Overview

Routing Information Protocol (RIP, RFC 1058 and RFC 1389) allows the Zyxel Device to exchange routing information with other routers. To activate RIP for the WAN interface, select the supported RIP version and operation.

### 10.5.1 RIP

Click **Network Setting > Routing > RIP** to open the **RIP** screen. Select the desired RIP version and operation by clicking the checkbox. To stop RIP on the WAN interface, clear the checkbox. Click the **Apply** button to start or stop RIP and save the configuration.

Figure 130 Network Setting &gt; Routing &gt; RIP

Static Route | DNS Route | Policy Route | **RIP**

To activate RIP for the WAN Interface, select the desired RIP version and operation and place a check in the Enabled checkbox. To stop RIP on the WAN Interface, uncheck the Enabled checkbox. Click the Apply button to start/stop RIP and save the configuration.

#	Interface	Version	Operation	Enable	Disable Default Gateway
1	Cellular WAN	RIPv2	Active	<input type="checkbox"/>	<input type="checkbox"/>
2	ETHWAN	RIPv2	Active	<input type="checkbox"/>	<input type="checkbox"/>

Cancel Apply

The following table describes the labels in this screen.

Table 62 Network Setting > Routing > RIP

LABEL	DESCRIPTION
#	This is the index of the interface in which the RIP setting is used.
Interface	This is the name of the interface in which the RIP setting is used.
Version	The RIP version controls the format and the broadcasting method of the RIP packets that the Zyxel Device sends (it recognizes both formats when receiving). <b>RIPv1</b> is universally supported but <b>RIPv2</b> carries more information. <b>RIPv1</b> is probably adequate for most networks, unless you have an unusual network topology. When set to <b>Both</b> , the Zyxel Device will broadcast its routing table periodically and incorporate the RIP information that it receives
Operation	Select <b>Passive</b> to have the Zyxel Device update the routing table based on the RIP packets received from neighbors but not advertise its route information to other routers in this interface.  Select <b>Active</b> to have the Zyxel Device advertise its route information and also listen for routing updates from neighboring routers.
Enable	Select the checkbox to activate the settings.
Disable Default Gateway	Select the checkbox to set the Zyxel Device to not send the route information to the default gateway.
Cancel	Click <b>Cancel</b> to exit this screen without saving.
Apply	Click <b>Apply</b> to save your changes back to the Zyxel Device.

# CHAPTER 11

## Quality of Service (QoS)

### 11.1 QoS Overview

Quality of Service (QoS) refers to both a network's ability to deliver data with minimum delay, and the networking methods used to control the use of bandwidth. Without QoS, all traffic data is equally likely to be dropped when the network is congested. This can cause a reduction in network performance and make the network inadequate for time-critical applications such as video-on-demand.

Configure QoS on the Zyxel Device to group and prioritize application traffic and fine-tune network performance. Setting up QoS involves these steps:

- 1 Configure classifiers to sort traffic into different flows.
- 2 Assign priority and define actions to be performed for a classified traffic flow.

The Zyxel Device assigns each packet a priority and then queues the packet accordingly. Packets assigned a high priority are processed more quickly than those with low priority if there is congestion, allowing time-sensitive applications to flow more smoothly. Time-sensitive applications include both those that require a low level of latency (delay) and a low level of jitter (variations in delay) such as Voice over IP (VoIP) or Internet gaming, and those for which jitter alone is a problem such as Internet radio or streaming video. There are eight priority levels, with 1 having the highest priority.

This chapter contains information about configuring QoS and editing classifiers.

#### 11.1.1 What You Can Do in this Chapter

- The **QoS** screen lets you enable or disable QoS and set the upstream bandwidth ([Section 11.3 on page 205](#)).

### 11.2 What You Need to Know

The following terms and concepts may help as you read through this chapter.

#### QoS versus CoS

QoS is used to prioritize source-to-destination traffic flows. All packets in the same flow are given the same priority. CoS (class of service) is a way of managing traffic in a network by grouping similar types of traffic together and treating each type as a class. You can use CoS to give different priorities to different packet types.

CoS technologies include IEEE 802.1p layer 2 tagging and DiffServ (Differentiated Services or DS). IEEE 802.1p tagging makes use of 3 bits in the packet header, while DiffServ is a new protocol and defines a new DS field, which replaces the eight-bit ToS (Type of Service) field in the IP header.

## Tagging and Marking

In a QoS class, you can configure whether to add or change the DSCP (DiffServ Code Point) value, IEEE 802.1p priority level and VLAN ID number in a matched packet. When the packet passes through a compatible network, the networking device, such as a backbone switch, can provide specific treatment or service based on the tag or marker.

## Traffic Shaping

Bursty traffic may cause network congestion. Traffic shaping regulates packets to be transmitted with a pre-configured data transmission rate using buffers (or queues). Your Zyxel Device uses the Token Bucket algorithm to allow a certain amount of large bursts while keeping a limit at the average rate.

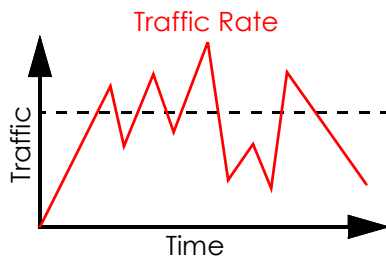

(Before Traffic Shaping)

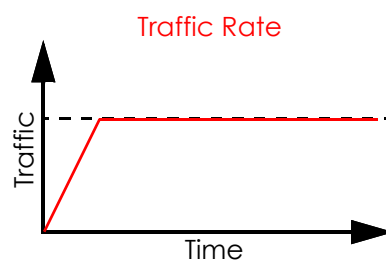

(After Traffic Shaping)

## Traffic Policing

Traffic policing is the limiting of the input or output transmission rate of a class of traffic on the basis of user-defined criteria. Traffic policing methods measure traffic flows against user-defined criteria and identify it as either conforming, exceeding or violating the criteria.

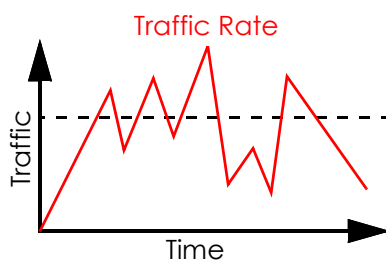

(Before Traffic Policing)

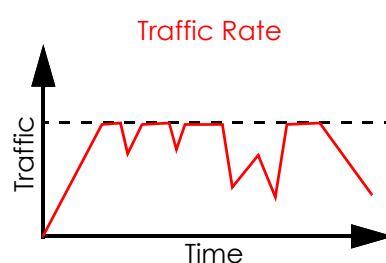

(After Traffic Policing)

The Zyxel Device supports three incoming traffic metering algorithms: Token Bucket Filter (TBF), Single Rate Two Color Marker (srTCM), and Two Rate Two Color Marker (trTCM). You can specify actions which are performed on the colored packets. See [Section 11.4 on page 207](#) for more information on each metering algorithm.

## Strictly Priority

Strictly Priority (SP) services queues based on priority only. As traffic comes into the Switch, traffic on the highest priority queue, Q7 is transmitted first. When that queue empties, traffic on the next highest priority queue, Q6 is transmitted until Q6 empties, and then traffic is transmitted on Q5 and so on. If higher priority queues never empty, then traffic on lower priority queues never gets sent. SP does not automatically adapt to changing network requirements.

## Weighted Round Robin Schedule (WRR)

Round Robin Scheduling services queues on a rotating basis and is activated only when a port has more traffic than it can handle. A queue is given an amount of bandwidth irrespective of the incoming traffic on that port. This queue then moves to the back of the list. The next queue is given an equal amount of bandwidth, and then moves to the end of the list; and so on, depending on the number of queues being used. This works in a looping fashion until a queue is empty.

Weighted Round Robin Scheduling (WRR) uses the same algorithm as round robin scheduling, but services queues based on their priority and queue weight (the number you configure in the queue **Weight** field) rather than a fixed amount of bandwidth. WRR is activated only when a port has more traffic than it can handle. Queues with larger weights get more service than queues with smaller weights. This queuing mechanism is highly efficient in that it divides any available bandwidth across the different traffic queues and returns to queues that have not yet emptied.

## 11.3 Quality of Service General Settings

Use this screen to enable or disable QoS and set the upstream bandwidth or assign traffic priority. See [Section 11.1 on page 203](#) for more information.

When one of the following situations happens, the current WAN linkup rate will be used instead:

- 1 **WAN Managed Upstream Bandwidth** is set to 0
- 2 **WAN Managed Upstream Bandwidth** is empty
- 3 **WAN Managed Upstream Bandwidth** is higher than the current WAN interface linkup rate

Note: Manually defined QoS is ignored when **Upstream Traffic Priority** is selected.

Note: **Upstream Traffic Priority** automatically assigns a traffic priority level based on the selected criteria.

Note: To have your QoS settings configured in other **QoS** screens take effect, select **None** in the **Upstream Traffic Priority Assigned by** field.

Click **Network Setting > QoS > General** to open the screen as shown next.

Figure 131 Network Setting &gt; QoS &gt; General

## QoS

Quality of Service (QoS) defines the traffic priority of Internet services to the home network.

QoS

WAN Managed Upstream Bandwidth  (kbps)

LAN Managed Downstream Bandwidth  (kbps)

Upstream Traffic Priority Assigned by

Note

- (1) You can assign the upstream bandwidth manually. If the field is empty, the CPE set the value automatically.
- (2) If Upstream Traffic Priority is selected, 8 level strict priority QoS will be applied automatically according to the selected criteria. In this mode, user manually defined QoS will not be applied until Auto-Priority Mapping is disabled.
- (3) If the setting of WAN managed upstream bandwidth is greater than current WAN interface linkup rate, then the WAN managed upstream bandwidth will become current WAN interface linkup rate.

The following table describes the labels in this screen.

Table 63 Network Setting &gt; QoS &gt; General

LABEL	DESCRIPTION
QoS	Click this switch to enable QoS to improve your network performance.
WAN Managed Upstream Bandwidth	<p>Enter the amount of upstream bandwidth for the WAN interfaces that you want to allocate using QoS.</p> <p>The recommendation is to set this speed to match the interfaces' actual transmission speed. For example, set the WAN interfaces' speed to 100000 kbps if your Internet connection has an upstream transmission speed of 100 Mbps.</p> <p>You can also set this number lower than the interfaces' actual transmission speed. This will cause the Zyxel Device to not use some of the interfaces' available bandwidth.</p> <p>If you leave this field blank, the Zyxel Device automatically sets this number to be 95% of the WAN interfaces' actual upstream transmission speed.</p>
LAN Managed Downstream Bandwidth	<p>Enter the amount of downstream bandwidth for the LAN interfaces (including WLAN) that you want to allocate using QoS.</p> <p>The recommendation is to set this speed to match the WAN interfaces' actual transmission speed. For example, set the LAN managed downstream bandwidth to 100000 kbps if you use a 100 Mbps wired Ethernet WAN connection.</p> <p>You can also set this number lower than the WAN interfaces' actual transmission speed. This will cause the Zyxel Device to not use some of the interfaces' available bandwidth.</p> <p>If you leave this field blank, the Zyxel Device automatically sets this to the LAN interfaces' maximum supported connection speed.</p>
Cancel	Click <b>Cancel</b> to restore your previously saved settings.
Apply	Click <b>Apply</b> to save your changes.

## 11.4 Technical Reference

The following section contains additional technical information about the Zyxel Device features described in this chapter.

### IEEE 802.1Q Tag

The IEEE 802.1Q standard defines an explicit VLAN tag in the MAC header to identify the VLAN membership of a frame across bridges. A VLAN tag includes the 12-bit VLAN ID and 3-bit user priority. The VLAN ID associates a frame with a specific VLAN and provides the information that devices need to process the frame across the network.

IEEE 802.1p specifies the user priority field and defines up to eight separate traffic types. The following table describes the traffic types defined in the IEEE 802.1d standard (which incorporates the 802.1p).

Table 64 IEEE 802.1p Priority Level and Traffic Type

PRIORITY LEVEL	TRAFFIC TYPE
Level 7	Typically used for network control traffic such as router configuration messages.
Level 6	Typically used for voice traffic that is especially sensitive to jitter (jitter is the variations in delay).
Level 5	Typically used for video that consumes high bandwidth and is sensitive to jitter.
Level 4	Typically used for controlled load, latency-sensitive traffic such as SNA (Systems Network Architecture) transactions.
Level 3	Typically used for "excellent effort" or better than best effort and would include important business traffic that can tolerate some delay.
Level 2	This is for "spare bandwidth".
Level 1	This is typically used for non-critical "background" traffic such as bulk transfers that are allowed but that should not affect other applications and users.
Level 0	Typically used for best-effort traffic.

### DiffServ

QoS is used to prioritize source-to-destination traffic flows. All packets in the flow are given the same priority. You can use CoS (class of service) to give different priorities to different packet types.

DiffServ (Differentiated Services) is a class of service (CoS) model that marks packets so that they receive specific per-hop treatment at DiffServ-compliant network devices along the route based on the application types and traffic flow. Packets are marked with DiffServ Code Points (DSCPs) indicating the level of service desired. This allows the intermediary DiffServ-compliant network devices to handle the packets differently depending on the code points without the need to negotiate paths or remember state information for every flow. In addition, applications do not have to request a particular service or give advanced notice of where the traffic is going.

### DSCP and Per-Hop Behavior

DiffServ defines a new Differentiated Services (DS) field to replace the Type of Service (TOS) field in the IP header. The DS field contains a 2-bit unused field and a 6-bit DSCP field which can define up to 64 service levels. The following figure illustrates the DS field.

DSCP is backward compatible with the three precedence bits in the ToS octet so that non-DiffServ compliant, ToS-enabled network device will not conflict with the DSCP mapping.

DSCP (6 bits)	Unused (2 bits)
---------------	-----------------

The DSCP value determines the forwarding behavior, the PHB (Per-Hop Behavior), that each packet gets across the DiffServ network. Based on the marking rule, different kinds of traffic can be marked for different kinds of forwarding. Resources can then be allocated according to the DSCP values and the configured policies.

## IP Precedence

Similar to IEEE 802.1p prioritization at layer-2, you can use IP precedence to prioritize packets in a layer-3 network. IP precedence uses three bits of the eight-bit ToS (Type of Service) field in the IP header. There are eight classes of services (ranging from zero to seven) in IP precedence. Zero is the lowest priority level and seven is the highest.

## Automatic Priority Queue Assignment

If you enable QoS on the Zyxel Device, the Zyxel Device can automatically base on the IEEE 802.1p priority level, IP precedence and/or packet length to assign priority to traffic which does not match a class.

The following table shows you the internal layer-2 and layer-3 QoS mapping on the Zyxel Device. On the Zyxel Device, traffic assigned to higher priority queues gets through faster while traffic in lower index queues is dropped if the network is congested.

Table 65 Internal Layer2 and Layer3 QoS Mapping

PRIORITY QUEUE	LAYER 2	LAYER 3		
	IEEE 802.1P USER PRIORITY (ETHERNET PRIORITY)	TOS (IP PRECEDENCE)	DSCP	IP PACKET LENGTH (BYTE)
0	1	0	000000	
1	2			
2	0	0	000000	>1100
3	3	1	001110 001100 001010 001000	250 – 1100
4	4	2	010110 010100 010010 010000	
5	5	3	011110 011100 011010 011000	<250



Table 65 Internal Layer2 and Layer3 QoS Mapping (continued)

PRIORITY QUEUE	LAYER 2	LAYER 3		
	IEEE 802.1P USER PRIORITY (ETHERNET PRIORITY)	TOS (IP PRECEDENCE)	DSCP	IP PACKET LENGTH (BYTE)
6	6	4	100110	
			100100	
		100010		
		100000		
7	7	5	101110	
			101000	
7	7	6	110000	
		7	111000	

## Token Bucket

The token bucket algorithm uses tokens in a bucket to control when traffic can be transmitted. The bucket stores tokens, each of which represents one byte. The algorithm allows bursts of up to  $b$  bytes which is also the bucket size, so the bucket can hold up to  $b$  tokens. Tokens are generated and added into the bucket at a constant rate. The following shows how tokens work with packets:

- A packet can be transmitted if the number of tokens in the bucket is equal to or greater than the size of the packet (in bytes).
- After a packet is transmitted, a number of tokens corresponding to the packet size is removed from the bucket.
- If there are no tokens in the bucket, the Zyxel Device stops transmitting until enough tokens are generated.
- If not enough tokens are available, the Zyxel Device treats the packet in either one of the following ways:

In traffic shaping:

- Holds it in the queue until enough tokens are available in the bucket.

In traffic policing:

- Drops it.
- Transmits it but adds a DSCP mark. The Zyxel Device may drop these marked packets if the network is overloaded.

Configure the bucket size to be equal to or less than the amount of the bandwidth that the interface can support. It does not help if you set it to a bucket size over the interface's capability. The smaller the bucket size, the lower the data transmission rate and that may cause outgoing packets to be dropped. A larger transmission rate requires a big bucket size. For example, use a bucket size of 10 kbytes to get the transmission rate up to 10 Mbps.

## Single Rate Three Color Marker

The Single Rate Three Color Marker (srTCM, defined in RFC 2697) is a type of traffic policing that identifies packets by comparing them to one user-defined rate, the Committed Information Rate (CIR), and two burst sizes: the Committed Burst Size (CBS) and Excess Burst Size (EBS).

The srTCM evaluates incoming packets and marks them with one of three colors which refer to packet loss priority levels. High packet loss priority level is referred to as red, medium is referred to as yellow and low is referred to as green.

The srTCM is based on the token bucket filter and has two token buckets (CBS and EBS). Tokens are generated and added into the bucket at a constant rate, called Committed Information Rate (CIR). When the first bucket (CBS) is full, new tokens overflow into the second bucket (EBS).

All packets are evaluated against the CBS. If a packet does not exceed the CBS it is marked green. Otherwise it is evaluated against the EBS. If it is below the EBS then it is marked yellow. If it exceeds the EBS then it is marked red.

The following shows how tokens work with incoming packets in srTCM:

- A packet arrives. The packet is marked green and can be transmitted if the number of tokens in the CBS bucket is equal to or greater than the size of the packet (in bytes).
- After a packet is transmitted, a number of tokens corresponding to the packet size is removed from the CBS bucket.
- If there are not enough tokens in the CBS bucket, the Zyxel Device checks the EBS bucket. The packet is marked yellow if there are sufficient tokens in the EBS bucket. Otherwise, the packet is marked red. No tokens are removed if the packet is dropped.

## Two Rate Three Color Marker

The Two Rate Three Color Marker (trTCM, defined in RFC 2698) is a type of traffic policing that identifies packets by comparing them to two user-defined rates: the Committed Information Rate (CIR) and the Peak Information Rate (PIR). The CIR specifies the average rate at which packets are admitted to the network. The PIR is greater than or equal to the CIR. CIR and PIR values are based on the guaranteed and maximum bandwidth respectively as negotiated between a service provider and client.

The trTCM evaluates incoming packets and marks them with one of three colors which refer to packet loss priority levels. High packet loss priority level is referred to as red, medium is referred to as yellow and low is referred to as green.

The trTCM is based on the token bucket filter and has two token buckets (Committed Burst Size (CBS) and Peak Burst Size (PBS)). Tokens are generated and added into the two buckets at the CIR and PIR respectively.

All packets are evaluated against the PIR. If a packet exceeds the PIR it is marked red. Otherwise it is evaluated against the CIR. If it exceeds the CIR then it is marked yellow. Finally, if it is below the CIR then it is marked green.

The following shows how tokens work with incoming packets in trTCM:

- A packet arrives. If the number of tokens in the PBS bucket is less than the size of the packet (in bytes), the packet is marked red and may be dropped regardless of the CBS bucket. No tokens are removed if the packet is dropped.
- If the PBS bucket has enough tokens, the Zyxel Device checks the CBS bucket. The packet is marked green and can be transmitted if the number of tokens in the CBS bucket is equal to or greater than the size of the packet (in bytes). Otherwise, the packet is marked yellow.

# CHAPTER 12

# Network Address Translation (NAT)

## 12.1 NAT Overview

NAT (Network Address Translation – NAT, RFC 1631) is the translation of the IP address of a host in a packet, for example, the source address of an outgoing packet, used within one network to a different IP address known within another network.

### 12.1.1 What You Can Do in this Chapter

- Use the **Port Forwarding** screen to configure forward incoming service requests to the servers on your local network ([Section 12.2 on page 212](#)).
- Use the **Port Triggering** screen to add and configure the Zyxel Device's trigger port settings ([Section 12.3 on page 215](#)).
- Use the **DMZ** screen to configure a default server ([Section 12.4 on page 219](#)).
- Use the **ALG** screen to enable or disable the SIP ALG ([Section 12.5 on page 219](#)).

### 12.1.2 What You Need To Know

The following terms and concepts may help as you read this chapter.

#### Inside/Outside and Global/Local

Inside/outside denotes where a host is located relative to the Zyxel Device, for example, the computers of your subscribers are the inside hosts, while the web servers on the Internet are the outside hosts.

Global/local denotes the IP address of a host in a packet as the packet traverses a router, for example, the local address refers to the IP address of a host when the packet is in the local network, while the global address refers to the IP address of the host when the same packet is traveling in the WAN side.

#### NAT

In the simplest form, NAT changes the source IP address in a packet received from a subscriber (the inside local address) to another (the inside global address) before forwarding the packet to the WAN side. When the response comes back, NAT translates the destination address (the inside global address) back to the inside local address before forwarding it to the original inside host.

## Port Forwarding

A port forwarding set is a list of inside (behind NAT on the LAN) servers, for example, web or FTP, that you can make visible to the outside world even though NAT makes your whole inside network appear as a single computer to the outside world.

## 12.2 Port Forwarding

Use **Port Forwarding** to forward incoming service requests from the Internet to the servers on your local network. Port forwarding is commonly used when you want to host online gaming, P2P file sharing, or other servers on your network.

You may enter a single port number or a range of port numbers to be forwarded, and the local IP address of the desired server. The port number identifies a service; for example, web service is on port 80 and FTP on port 21. In some cases, such as for unknown services or where one server can support more than one service (for example both FTP and web service), it might be better to specify a range of port numbers. You can allocate a server IP address that corresponds to a port or a range of ports. Please refer to RFC 1700 for further information about port numbers.

Note: Many residential broadband ISP accounts do not allow you to run any server processes (such as a Web or FTP server) from your location. Your ISP may periodically check for servers and may suspend your account if it discovers any active services at your location. If you are unsure, refer to your ISP.

### Configure Servers Behind Port Forwarding (Example)

Let's say you want to assign ports 21-25 to one FTP, Telnet and SMTP server (**A** in the example), port 80 to another (**B** in the example), a default server IP address of 192.168.1.35 to a third (**C** in the example), and a default server IP address of 192.168.1.36 to a fourth (**D** in the example). You assign the LAN IP addresses and the ISP assigns the WAN IP address. The NAT network appears as a single host on the Internet.

Figure 132 Multiple Servers Behind NAT Example

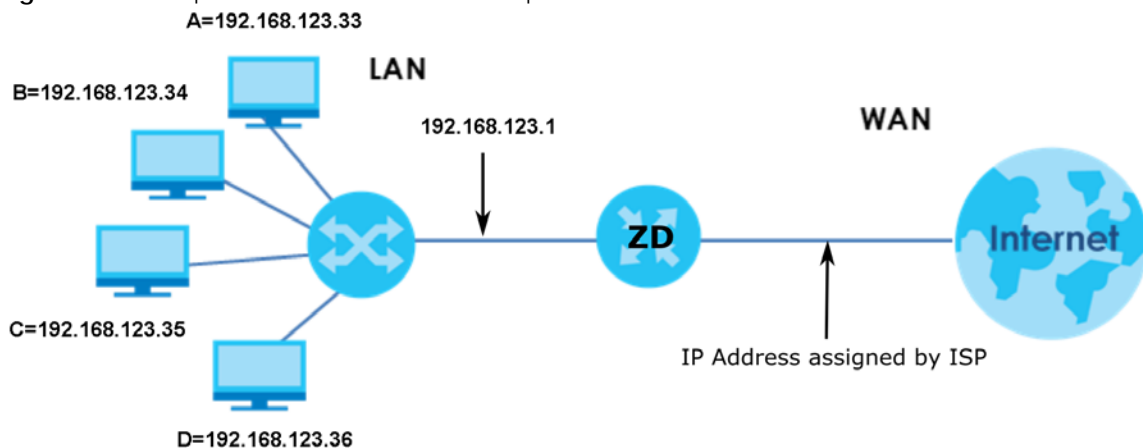

### 12.2.1 Port Forwarding

Click **Network Setting** > **NAT** to open the **Port Forwarding** screen.

Note: TCP port 7547 is reserved for system use.

**Figure 133** Network Setting > NAT > Port Forwarding

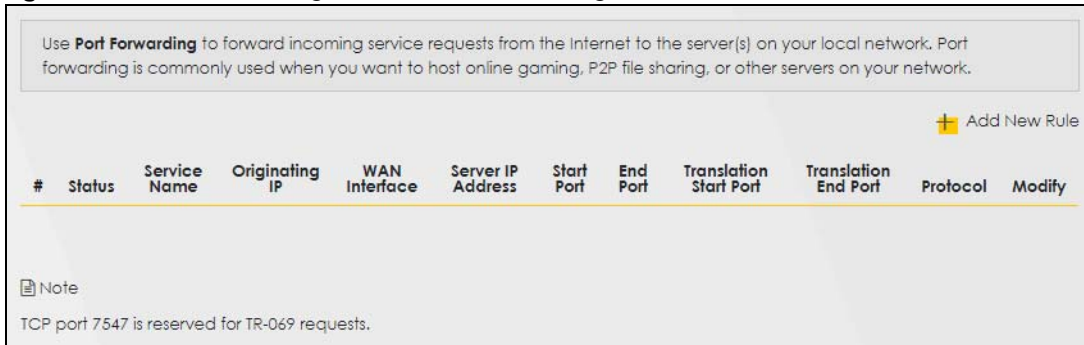

The following table describes the fields in this screen.

**Table 66** Network Setting > NAT > Port Forwarding

LABEL	DESCRIPTION
Add New Rule	Click this to add a new port forwarding rule.
#	This is the index number of the entry.
Status	This field indicates whether the rule is active or not. A yellow bulb signifies that this rule is active. A gray bulb signifies that this rule is not active.
Service Name	This is the service's name. This shows <b>User Defined</b> if you manually added a service. You can change this by clicking the edit icon.
Originating IP	This is the source's IP address.
WAN Interface	Select the WAN interface for which to configure NAT port forwarding rules.
Server IP Address	This is the server's IP address.
Start Port	This is the first external port number that identifies a service.
End Port	This is the last external port number that identifies a service.
Translation Start Port	This is the first internal port number that identifies a service.
Translation End Port	This is the last internal port number that identifies a service.
Protocol	This field displays the protocol (TCP, UDP, TCP+UDP) used to transport the packets for which you want to apply the rule.
Modify	Click the <b>Edit</b> icon to edit the port forwarding rule. Click the <b>Delete</b> icon to delete an existing port forwarding rule. Note that subsequent address mapping rules move up by one when you take this action.

## 12.2.2 Add or Edit Port Forwarding

Create or edit a port forwarding rule. Specify either a port or a range of ports, a server IP address, and a protocol to configure a port forwarding rule. Click **Add New Rule** in the **Port Forwarding** screen or the **Edit** icon next to an existing rule to open the following screen.

**Figure 134** Network Setting > NAT > Port Forwarding: Add or Edit

**Add New Rule**

Active

Service Name

WAN Interface

Start Port

End Port

Translation Start Port

Translation End Port

Server IP Address

Configure Originating IP  Enable

Originating IP

Protocol

**Note**

(1) Create or edit a port forwarding rule. Specify either a port or a range of ports, a server IP address, and a protocol to configure a port forwarding rule.

(2) To configure port forwarding, you need to have the same configurations in the **Start Port**, **End Port**, **Translation Start Port**, and **Translation End Port** fields.  
To configure port translation, you need to have different configurations in the **Start Port**, **End Port**, **Translation Start Port**, and **Translation End Port** fields.

(3) TCP port 7547 is reserved for system use.

Cancel OK

Note: To configure port forwarding, you need to have the same configurations in the **Start Port**, **End Port**, **Translation Start Port**, and **Translation End Port** fields.  
To configure port translation, you need to have different configurations in the **Start Port**, **End Port**, **Translation Start Port**, and **Translation End Port** fields.  
Here is an example to configure port translation. Configure **Start Port** to 100, **End Port** to 120, **Translation Start Port** to 200, and **Translation End Port** to 220.

Note: TCP port 7547 is reserved for system use.

The following table describes the labels in this screen.

**Table 67** Network Setting > NAT > Port Forwarding: Add or Edit

LABEL	DESCRIPTION
Active	Click to turn the port forwarding rule on or off.
Service Name	Enter a name for the service to forward. You can use up to 256 printable characters except [ " ], [ ` ], [ ' ], [ < ], [ > ], [ ^ ], [ \$ ], [   ], [ & ], or [ ; ]. Spaces are allowed.
WAN Interface	Select the WAN interface for which to configure NAT port forwarding rules.

Table 67 Network Setting &gt; NAT &gt; Port Forwarding: Add or Edit (continued)

LABEL	DESCRIPTION
Start Port	Configure this for a user-defined entry. Enter the original destination port for the packets. To forward only one port, enter the port number again in the <b>End Port</b> field. To forward a series of ports, enter the start port number here and the end port number in the <b>End Port</b> field.
End Port	Configure this for a user-defined entry. Enter the last port of the original destination port range. To forward only one port, enter the port number in the <b>Start Port</b> field above and then enter it again in this field. To forward a series of ports, enter the last port number in a series that begins with the port number in the <b>Start Port</b> field above.
Translation Start Port	Configure this for a user-defined entry. This shows the port number to which you want the Zyxel Device to translate the incoming port. For a range of ports, enter the first number of the range to which you want the incoming ports translated.
Translation End Port	Configure this for a user-defined entry. This shows the last port of the translated port range.
Server IP Address	Enter the inside IP address of the virtual server here.
Configure Originating IP	Click the <b>Enable</b> checkbox to enter the source IP in the next field.
Originating IP	Enter the source IP address here.
Protocol	Select the protocol supported by this virtual server. Choices are <b>TCP</b> , <b>UDP</b> , or <b>TCP/UDP</b> .
OK	Click this to save your changes.
Cancel	Click this to exit this screen without saving.

## 12.3 Port Triggering

Some services use a dedicated range of ports on the client side and a dedicated range of ports on the server side. With regular port forwarding, you set a forwarding port in NAT to forward a service (coming in from the server on the WAN) to the IP address of a computer on the client side (LAN). The problem is that port forwarding only forwards a service to a single LAN IP address. In order to use the same service on a different LAN computer, you have to manually replace the LAN computer's IP address in the forwarding port with another LAN computer's IP address.

Trigger port forwarding allows computers on the LAN to dynamically take turns using the service.

The Zyxel Device records the IP address of a LAN computer that sends traffic to the WAN to request a service with a specific port number and protocol (a \"trigger\" port). When the Zyxel Device's WAN port receives a response with a specific port number and protocol (\"open\" port), the Zyxel Device forwards the traffic to the LAN IP address of the computer that sent the request. After that computer's connection for that service closes, another computer on the LAN can use the service in the same manner. This way you do not need to configure a new IP address each time you want a different LAN computer to use the application.

For example:

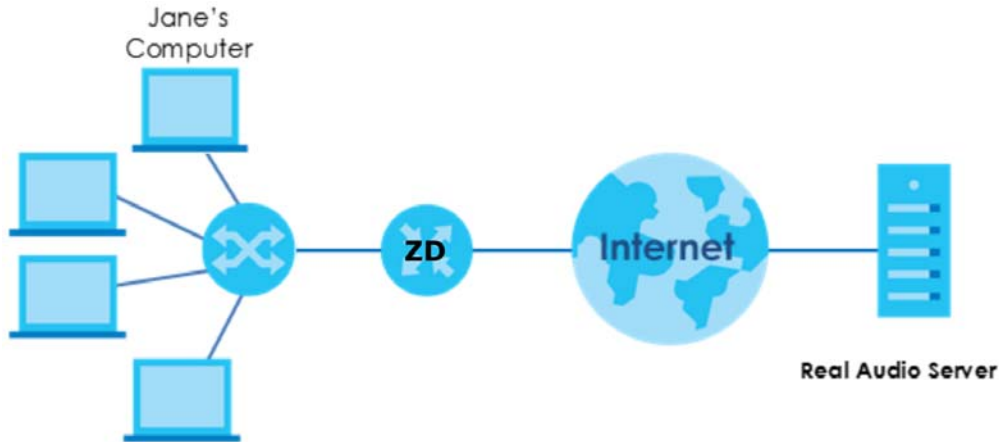
**Figure 135** Trigger Port Forwarding Process: Example

- 1 Jane requests a file from the Real Audio server (port 7070).
- 2 Port 7070 is a "trigger" port and causes the Zykel Device to record Jane's computer IP address. The Zykel Device associates Jane's computer IP address with the "open" port range of 6970 – 7170.
- 3 The Real Audio server responds using a port number ranging between 6970 – 7170.
- 4 The Zykel Device forwards the traffic to Jane's computer IP address.
- 5 Only Jane can connect to the Real Audio server until the connection is closed or times out. The Zykel Device times out in 3 minutes with UDP (User Datagram Protocol) or 2 hours with TCP/IP (Transfer Control Protocol/Internet Protocol).

Click **Network Setting > NAT > Port Triggering** to open the following screen. Use this screen to view your Zykel Device's trigger port settings.

Note: TCP port 7547 is reserved for system use.

Note: The sum of trigger ports in all rules must be less than 1000 and every open port range must be less than 1000. When the protocol is TCP/UDP, the ports are counted twice.

**Figure 136** Network Setting > NAT > Port Triggering

Trigger port forwarding allows computers on the LAN to dynamically take turns using the service. The Zykel Device records the IP address of a LAN computer that sends traffic to the WAN to request a service with a specific port number and protocol (a "trigger" port). When the Zykel Device's WAN port receives a response with a specific port number and protocol ("open" port), the Zykel Device forwards the traffic to the LAN IP address of the computer that sent the request. After that computer's connection for that service closes, another computer on the LAN can use the service in the same manner. This way you do not need to configure a new IP address each time you want a different LAN computer to use the application.

+ Add New Rule

#	Status	Service Name	WAN Interface	Trigger Start Port	Trigger End Port	Trigger Proto.	Open Start Port	Open End Port	Open Protocol	Modify
<p>Note</p> <p>TCP port 7547 is reserved for system use.</p>										



The following table describes the labels in this screen.

Table 68 Network Setting > NAT > Port Triggering

LABEL	DESCRIPTION
Add New Rule	Click this to create a new rule.
#	This is the index number of the entry.
Status	This field displays whether the port triggering rule is active or not. A yellow bulb signifies that this rule is active. A gray bulb signifies that this rule is not active.
Service Name	This field displays the name of the service used by this rule.
WAN Interface	This field shows the WAN interface through which the service is forwarded.
Trigger Start Port	The trigger port is a port (or a range of ports) that causes (or triggers) the Zyxel Device to record the IP address of the LAN computer that sent the traffic to a server on the WAN.  This is the first port number that identifies a service.
Trigger End Port	This is the last port number that identifies a service.
Trigger Proto.	This is the trigger transport layer protocol.
Open Start Port	The open port is a port (or a range of ports) that a server on the WAN uses when it sends out a particular service. The Zyxel Device forwards the traffic with this port (or range of ports) to the client computer on the LAN that requested the service.  This is the first port number that identifies a service.
Open End Port	This is the last port number that identifies a service.
Open Protocol	This is the open transport layer protocol.
Modify	Click the <b>Edit</b> icon to edit this rule.  Click the <b>Delete</b> icon to delete an existing rule.

### 12.3.1 Add or Edit Port Triggering Rule

This screen lets you create new port triggering rules. Click **Add New Rule** in the **Port Triggering** screen or click a rule's **Edit** icon to open the following screen. Use this screen to configure a port or range of ports and protocols for sending out requests and for receiving responses.

**Figure 137** Network Setting > NAT > Port Triggering: Add or Edit

The following table describes the labels in this screen.

**Table 69** Network Setting > NAT > Port Triggering: Add or Edit

LABEL	DESCRIPTION
Active	Click this switch to activate this rule.
Service Name	Enter a name to identify this rule. You can use up to 256 printable characters except [ " ], [ ` ], [ ' ], [ < ], [ > ], [ ^ ], [ \$ ], [   ], [ & ], or [ ; ]. Spaces are allowed.
WAN Interface	Select a WAN interface for which you want to configure port triggering rules.
Trigger Start Port	The trigger port is a port (or a range of ports) that causes (or triggers) the Zyxel Device to record the IP address of the LAN computer that sent the traffic to a server on the WAN. Enter a port number or the starting port number in a range of port numbers.
Trigger End Port	Enter a port number or the ending port number in a range of port numbers.
Trigger Protocol	Select the transport layer protocol from <b>TCP</b> , <b>UDP</b> , or <b>TCP/UDP</b> .
Open Start Port	The open port is a port (or a range of ports) that a server on the WAN uses when it sends out a particular service. The Zyxel Device forwards the traffic with this port (or range of ports) to the client computer on the LAN that requested the service. Enter a port number or the starting port number in a range of port numbers.
Open End Port	Enter a port number or the ending port number in a range of port numbers.
Open Protocol	Select the transport layer protocol from <b>TCP</b> , <b>UDP</b> , or <b>TCP/UDP</b> .
Cancel	Click <b>Cancel</b> to exit this screen without saving.
OK	Click <b>OK</b> to save your changes.

## 12.4 DMZ

Use this screen to specify the IP address of a default server to receive packets from ports not specified in the **Port Triggering** screen. The DMZ (DeMilitarized Zone) is a network between the WAN and the LAN that is accessible to devices on both the WAN and LAN with firewall protection. Devices on the WAN can initiate connections to devices on the DMZ but not to those on the LAN.

You can put public servers, such as email, web, and FTP servers, on the DMZ to provide services on both the WAN and LAN. To use this feature, you first need to assign a DMZ host. Click **Network Setting > NAT > DMZ** to open the **DMZ** screen.

Note: Use an IPv4 address for the DMZ server.

Note: Enter the IP address of the default server in the **Default Server Address** field, and click **Apply** to activate the DMZ host. Otherwise, clear the IP address in the **Default Server Address** field, and click **Apply** to deactivate the DMZ host.

**Figure 138** Network Setting > NAT > DMZ

Use this screen to specify the IP address of a default server to receive packets from ports not specified in the **Port Triggering** screen. The DMZ (DeMilitarized Zone) is a network between the WAN and the LAN that is accessible to devices on both the WAN and LAN with firewall protection. Devices on the WAN can initiate connections to devices on the DMZ but not to those on the LAN.

You can put public servers, such as email, web, and FTP servers, on the DMZ to provide services on both the WAN and LAN. To use this feature, you first need to assign a DMZ host.

Default Server Address

Note  
Enter the IP address of the default server in the **Default Server Address** field, and click **Apply** to activate the DMZ host. Otherwise, clear the IP address in the **Default Server Address** field, and click **Apply** to deactivate the DMZ host.

**Cancel** **Apply**

The following table describes the fields in this screen.

**Table 70** Network Setting > NAT > DMZ

LABEL	DESCRIPTION
Default Server Address	Enter the IP address of the default server which receives packets from ports that are not specified in the <b>Port Forwarding</b> screen.  Note: If you do not assign a default server, the Zyxel Device discards all packets received for ports not specified in the virtual server configuration.
Apply	Click this to save your changes back to the Zyxel Device.
Cancel	Click <b>Cancel</b> to restore your previously saved settings.

## 12.5 ALG

Application Layer Gateway (ALG) allows customized NAT traversal filters to support address and port translation for certain applications such as File Transfer Protocol (FTP), Session Initiation Protocol (SIP), or file transfer in Instant Messaging (IM) applications. It allows SIP calls to pass through the Zyxel Device.

When the Zyxel Device registers with the SIP register server, the SIP ALG translates the Zyxel Device's private IP address inside the SIP data stream to a public IP address. You do not need to use STUN or an outbound proxy if your Zyxel Device is behind a SIP ALG.

Click **Network Setting > NAT > ALG** to open the **ALG** screen. Use this screen to enable and disable the NAT Application Layer Gateway (ALG) in the Zyxel Device.

Application Layer Gateway (ALG) allows certain applications such as File Transfer Protocol (FTP), Session Initiation Protocol (SIP), or file transfer in Instant Messaging (IM) applications to pass through the Zyxel Device.

**Figure 139** Network Setting > NAT > ALG

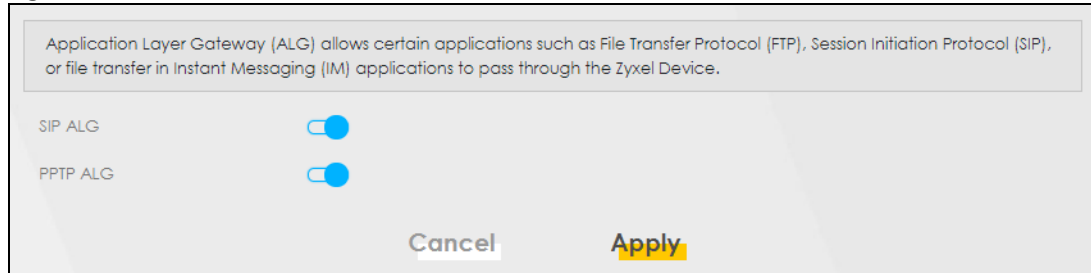

The following table describes the fields in this screen.

Table 71 Network Setting > NAT > ALG

LABEL	DESCRIPTION
SIP ALG	Click this switch to enable SIP ALG to make sure SIP (VoIP) works correctly with port-forwarding and address-mapping rules.
PPTP ALG	Click this switch to enable the PPTP ALG on the Zyxel Device to detect PPTP traffic and help build PPTP sessions through the Zyxel Device's NAT.
Apply	Click <b>Apply</b> to save your changes back to the Zyxel Device.
Cancel	Click <b>Cancel</b> to restore your previously saved settings.

## 12.6 Technical Reference

This part contains more information regarding NAT.

### 12.6.1 NAT Definitions

Inside or outside denotes where a host is located relative to the Zyxel Device, for example, the computers of your subscribers are the inside hosts, while the web servers on the Internet are the outside hosts.

Global or local denotes the IP address of a host in a packet as the packet traverses a router, for example, the local address refers to the IP address of a host when the packet is in the local network, while the global address refers to the IP address of the host when the same packet is traveling in the WAN side.

Note that inside or outside refers to the location of a host, while global/local refers to the IP address of a host used in a packet. Thus, an inside local address (ILA) is the IP address of an inside host in a packet when the packet is still in the local network, while an inside global address (IGA) is the IP address of the

same inside host when the packet is on the WAN side. The following table summarizes this information.

Table 72 NAT Definitions

ITEM	DESCRIPTION
Inside	This refers to the host on the LAN.
Outside	This refers to the host on the WAN.
Local	This refers to the packet address (source or destination) as the packet travels on the LAN.
Global	This refers to the packet address (source or destination) as the packet travels on the WAN.

NAT never changes the IP address (either local or global) of an outside host.

## 12.6.2 What NAT Does

In the simplest form, NAT changes the source IP address in a packet received from a subscriber (the inside local address) to another (the inside global address) before forwarding the packet to the WAN side. When the response comes back, NAT translates the destination address (the inside global address) back to the inside local address before forwarding it to the original inside host. Note that the IP address (either local or global) of an outside host is never changed.

The global IP addresses for the inside hosts can be either static or dynamically assigned by the ISP. In addition, you can designate servers, for example, a web server and a telnet server, on your local network and make them accessible to the outside world. If you do not define any servers (for Many-to-One and Many-to-Many Overload mapping), NAT offers the additional benefit of firewall protection. With no servers defined, your Zyxel Device filters out all incoming inquiries, thus preventing intruders from probing your network. For more information on IP address translation, refer to *RFC 1631, The IP Network Address Translator (NAT)*.

## 12.6.3 How NAT Works

Each packet has two addresses – a source address and a destination address. For outgoing packets, the ILA (Inside Local Address) is the source address on the LAN, and the IGA (Inside Global Address) is the source address on the WAN. For incoming packets, the ILA is the destination address on the LAN, and the IGA is the destination address on the WAN. NAT maps private (local) IP addresses to globally unique ones required for communication with hosts on other networks. It replaces the original IP source address (and TCP or UDP source port numbers for Many-to-One and Many-to-Many Overload NAT mapping) in each packet and then forwards it to the Internet. The Zyxel Device keeps track of the original addresses and port numbers so incoming reply packets can have their original values restored. The following figure illustrates this.

Figure 140 How NAT Works

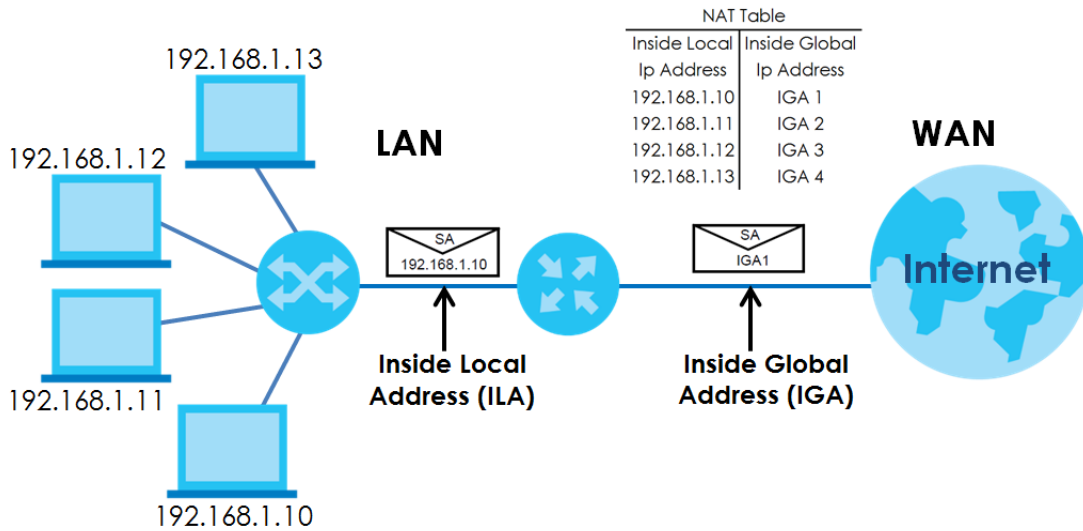

### 12.6.4 NAT Application

The following figure illustrates a possible NAT application, where three inside LANs (logical LANs using IP alias) behind the Zyxel Device can communicate with three distinct WAN networks.

Figure 141 NAT Application With IP Alias

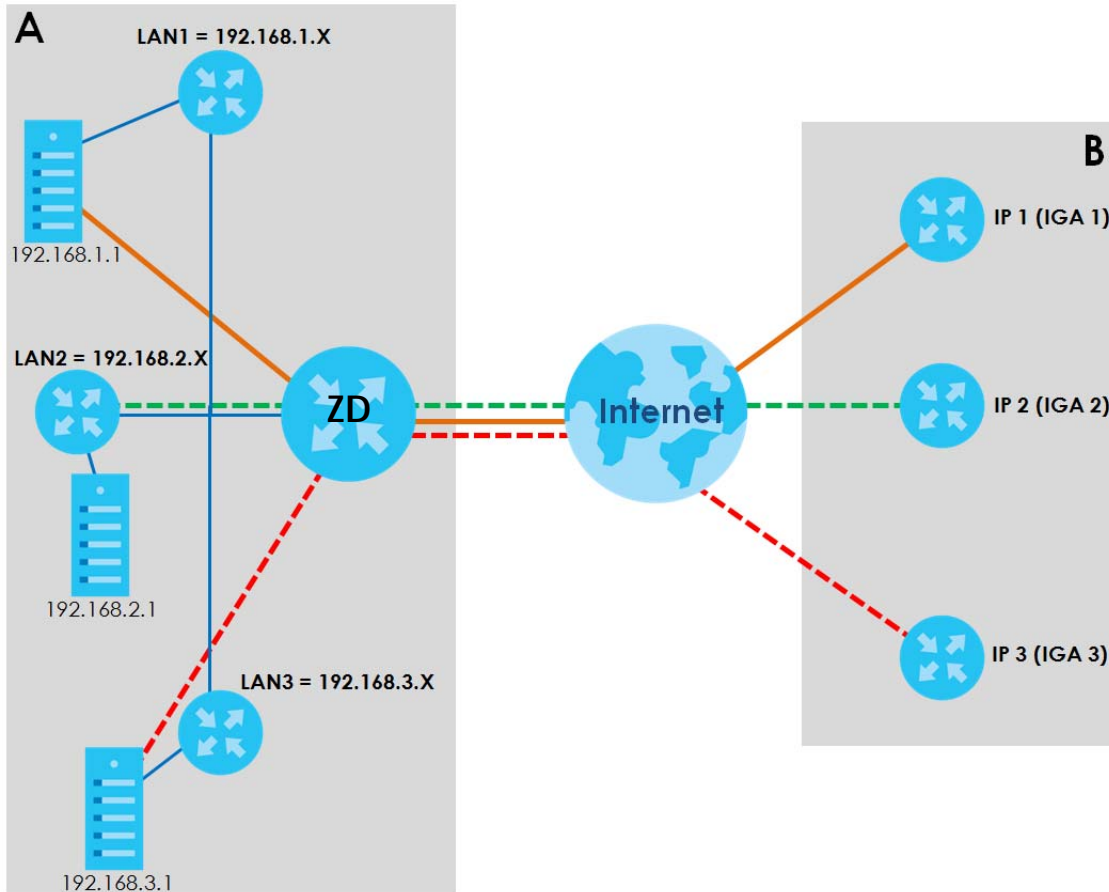

## Port Forwarding: Services and Port Numbers

The most often used port numbers are shown in the following table. Please refer to RFC 1700 for further information about port numbers. Please also refer to the Supporting CD for more examples and details on port forwarding and NAT.

Table 73 Services and Port Numbers

SERVICES	PORT NUMBER
ECHO	7
FTP (File Transfer Protocol)	21
SMTP (Simple Mail Transfer Protocol)	25
DNS (Domain Name System)	53
Finger	79
HTTP (Hyper Text Transfer protocol or WWW, Web)	80
POP3 (Post Office Protocol)	110
NNTP (Network News Transport Protocol)	119
SNMP (Simple Network Management Protocol)	161
SNMP trap	162
PPTP (Point-to-Point Tunneling Protocol)	1723

## Port Forwarding Example

Let's say you want to assign ports 21 – 25 to one FTP, Telnet and SMTP server (**A** in the example), port 80 to another (**B** in the example) and assign a default server IP address of 192.168.1.35 to a third (**C** in the example). You assign the LAN IP addresses and the ISP assigns the WAN IP address. The NAT network appears as a single host on the Internet.

Figure 142 Multiple Servers Behind NAT Example

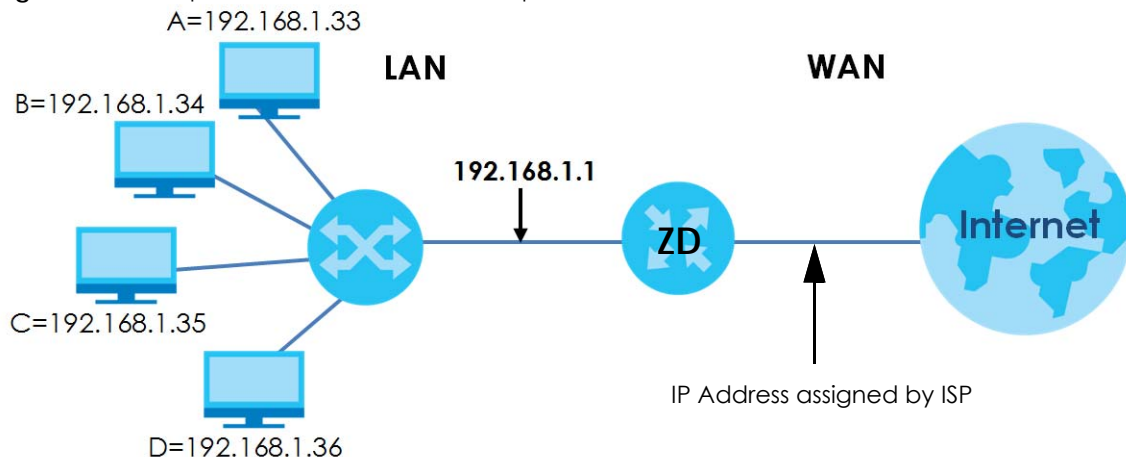

# CHAPTER 13

## DNS

### 13.1 DNS Overview

#### DNS

DNS (Domain Name System) is for mapping a domain name to its corresponding IP address and vice versa. The DNS server is extremely important because without it, you must know the IP address of a machine before you can access it.

In addition to the system DNS servers, each WAN interface (service) is set to have its own static or dynamic DNS server list. You can configure a DNS static route to forward DNS queries for certain domain names through a specific WAN interface to its DNS servers. The Zyxel Device uses a system DNS server (in the order you specify in the **Broadband** screen) to resolve domain names that do not match any DNS routing entry. After the Zyxel Device receives a DNS reply from a DNS server, it creates a new entry for the resolved IP address in the routing table.

#### Dynamic DNS

Dynamic DNS allows you to use a dynamic IP address with one or many dynamic DNS services so that anyone can contact you (in NetMeeting, CU-SeeMe, and so on). You can also access your FTP server or Web site on your own computer using a domain name (for instance myhost.dhs.org, where myhost is a name of your choice) that will never change instead of using an IP address that changes each time you reconnect. Your friends or relatives will always be able to call you even if they do not know your IP address.

You first need to have registered a dynamic DNS account with [www.dyndns.org](http://www.dyndns.org). This is for people with a dynamic IP from their ISP or DHCP server that would still like to have a domain name. The Dynamic DNS service provider will give you a password or key.

#### 13.1.1 What You Can Do in this Chapter

- Use the **DNS Entry** screen to view, configure, or remove DNS routes ([Section 13.2 on page 225](#)).
- Use the **Dynamic DNS** screen to enable DDNS and configure the DDNS settings on the Zyxel Device ([Section 13.3 on page 226](#)).

#### 13.1.2 What You Need To Know

##### DYNDNS Wildcard

Enabling the wildcard feature for your host causes \*.yourhost.dyndns.org to be aliased to the same IP address as yourhost.dyndns.org. This feature is useful if you want to be able to use, for example, www.yourhost.dyndns.org and still reach your hostname.



If you have a private WAN IP address, then you cannot use Dynamic DNS.

## 13.2 DNS Entry

DNS (Domain Name System) is used for mapping a domain name to its corresponding IP address and vice versa. Use this screen to view and configure manual DNS entries on the Zyxel Device. Click **Network Setting > DNS** to open the **DNS Entry** screen.

Note: The host name should consist of the host's local name and the domain name. For example, Mycomputer.home is a host name where Mycomputer is the host's local name, and .home is the domain name.

**Figure 143** Network Setting > DNS > DNS Entry

**DNS**

**DNS Entry** Dynamic DNS

DNS (Domain Name System) is used for mapping a domain name to its corresponding IP address and vice versa. Use this screen to view and configure DNS routes on the Zyxel Device.

+ Add New DNS Entry

#	HostName	IP Address	Modify

Note

The hostnames requires a combination of the host's local name with its domain name, for example, Mycomputer.home consists of a local hostname (Mycomputer) and the domain name (home).

The following table describes the fields in this screen.

**Table 74** Network Setting > DNS > DNS Entry

LABEL	DESCRIPTION
Add New DNS Entry	Click this to create a new DNS entry.
#	This is the index number of the entry.
HostName	This indicates the host name or domain name.
IP Address	This indicates the IP address assigned to this computer.
Modify	Click the <b>Edit</b> icon to edit the rule. Click the <b>Delete</b> icon to delete an existing rule.

### 13.2.1 Add or Edit DNS Entry

You can manually add or edit the Zyxel Device's DNS name and IP address entry. Click **Add New DNS Entry** in the **DNS Entry** screen or the **Edit** icon next to the entry you want to edit. The screen shown next appears.

**Figure 144** Network Setting > DNS > DNS Entry: Add or Edit

The following table describes the labels in this screen.

**Table 75** Network Setting > DNS > DNS Entry: Add or Edit

LABEL	DESCRIPTION
Host Name	Enter the host name of the DNS entry. You can use up to 256 alphanumeric (0-9, a-z, A-Z) characters with hyphens [ - ] and periods [ . ].  You can use the wildcard character, an "*" (asterisk) as the left most part of a domain name, such as *.example.com.
IPv4 Address	Enter the IPv4 address of the DNS entry.
Cancel	Click <b>Cancel</b> to exit this screen without saving.
OK	Click <b>OK</b> to save your changes.

## 13.3 Dynamic DNS

Dynamic DNS can update your current dynamic IP address mapping to a hostname. Configure a DDNS service provider on your Zyxel Device. Click **Network Setting > DNS > Dynamic DNS**. The screen appears as shown.

**Figure 145** Network Setting > DNS > Dynamic DNS

Dynamic DNS can update your current dynamic IP address mapping to a hostname. Configure a DDNS service provider on your Zyxel Device.

### Dynamic DNS Setup

Dynamic DNS  Enable  Disable (Settings are invalid when disable)

Service Provider

Host Name

Username

Password

Enable Wildcard Option

Enable Off Line Option (Only applies to custom DNS)

### Dynamic DNS Status

User Authentication Result

Last Updated Time

Current Dynamic IP

The following table describes the fields in this screen.

**Table 76** Network Setting > DNS > Dynamic DNS

LABEL	DESCRIPTION
Dynamic DNS Setup	
Dynamic DNS	Select <b>Enable</b> to use dynamic DNS.
Service Provider	Select your Dynamic DNS service provider from the drop-down list box.
Host Name	Enter the domain name assigned to your Zyxel Device by your Dynamic DNS provider. You can use up to 256 alphanumeric (0-9, a-z, A-Z) characters with hyphens [ - ] and periods [ . ]. You can specify up to two host names in the field separated by a comma (",").
Username	Enter your user name.
Password	Enter the password assigned to you.
Enable Wildcard Option	Select the checkbox to enable DynDNS Wildcard.
Enable Off Line Option (Only applies to custom DNS)	Check with your Dynamic DNS service provider to have traffic redirected to a URL (that you can specify) while you are off line.
Dynamic DNS Status	
User Authentication Result	This shows <b>Success</b> if the account is correctly set up with the Dynamic DNS provider account.
Last Updated Time	This shows the last time the IP address the Dynamic DNS provider has associated with the hostname was updated.
Current Dynamic IP	This shows the IP address your Dynamic DNS provider has currently associated with the hostname.

Table 76 Network Setting > DNS > Dynamic DNS (continued)

LABEL	DESCRIPTION
Cancel	Click <b>Cancel</b> to exit this screen without saving.
Apply	Click <b>Apply</b> to save your changes.

# CHAPTER 14

## USB Service

### 14.1 USB Service Overview

You can share files on a USB memory stick or hard drive connected to your Zyxel Device with users on your network.

The following figure is an overview of the Zyxel Device's file server feature. Computers **A** and **B** can access files on a USB device (**C**) which is connected to the Zyxel Device.

**Figure 146** File Sharing Overview

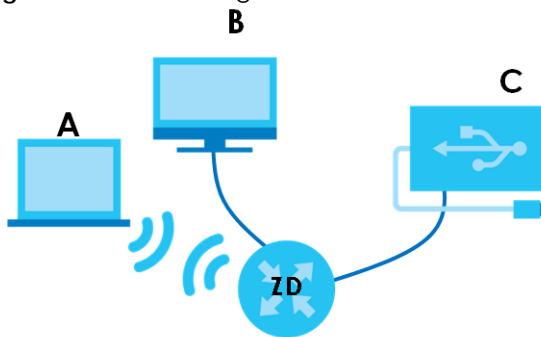

The Zyxel Device will not be able to join a workgroup if your local area network has restrictions set up that do not allow devices to join a workgroup. In this case, contact your network administrator.

#### 14.1.1 What You Need To Know

The following terms and concepts may help as you read this chapter.

##### 14.1.1.1 About File Sharing

###### Workgroup Name

This is the name given to a set of computers that are connected on a network and share resources such as a printer or files. Windows automatically assigns the workgroup name when you set up a network.

###### Shares

When settings are set to default, each USB device connected to the Zyxel Device is given a folder, called a "share". If a USB hard drive connected to the Zyxel Device has more than one partition, then each partition will be allocated a share. You can also configure a "share" to be a sub-folder or file on the USB device.

## File Systems

A file system is a way of storing and organizing files on your hard drive and storage device. Often different operating systems such as Windows or Linux have different file systems. The file sharing feature on your Zyxel Device supports File Allocation Table (FAT) and FAT32.

## Common Internet File System

The Zyxel Device uses Common Internet File System (CIFS) protocol for its file sharing functions. CIFS compatible computers can access the USB file storage devices connected to the Zyxel Device. CIFS protocol is supported on Microsoft Windows, Linux Samba and other operating systems (refer to your systems specifications for CIFS compatibility).

### 14.1.2 Before You Begin

- 1 Make sure the Zyxel Device is connected to your network and turned on.
- 2 Connect the USB device to one of the Zyxel Device's USB port. If you are connecting a USB hard drive that comes with an external power supply, make sure it is connected to an appropriate power source.
- 3 The Zyxel Device detects the USB device and makes its contents available for browsing.

Note: If your USB device cannot be detected by the Zyxel Device, see the troubleshooting for suggestions.

## 14.2 USB Service

Use this screen to set up file sharing through the Zyxel Device. The Zyxel Device's LAN users can access the shared folder (or share) from the USB device inserted in the Zyxel Device. To access this screen, click **Network Setting > USB Service**.

Figure 147 Network Setting > USB Service

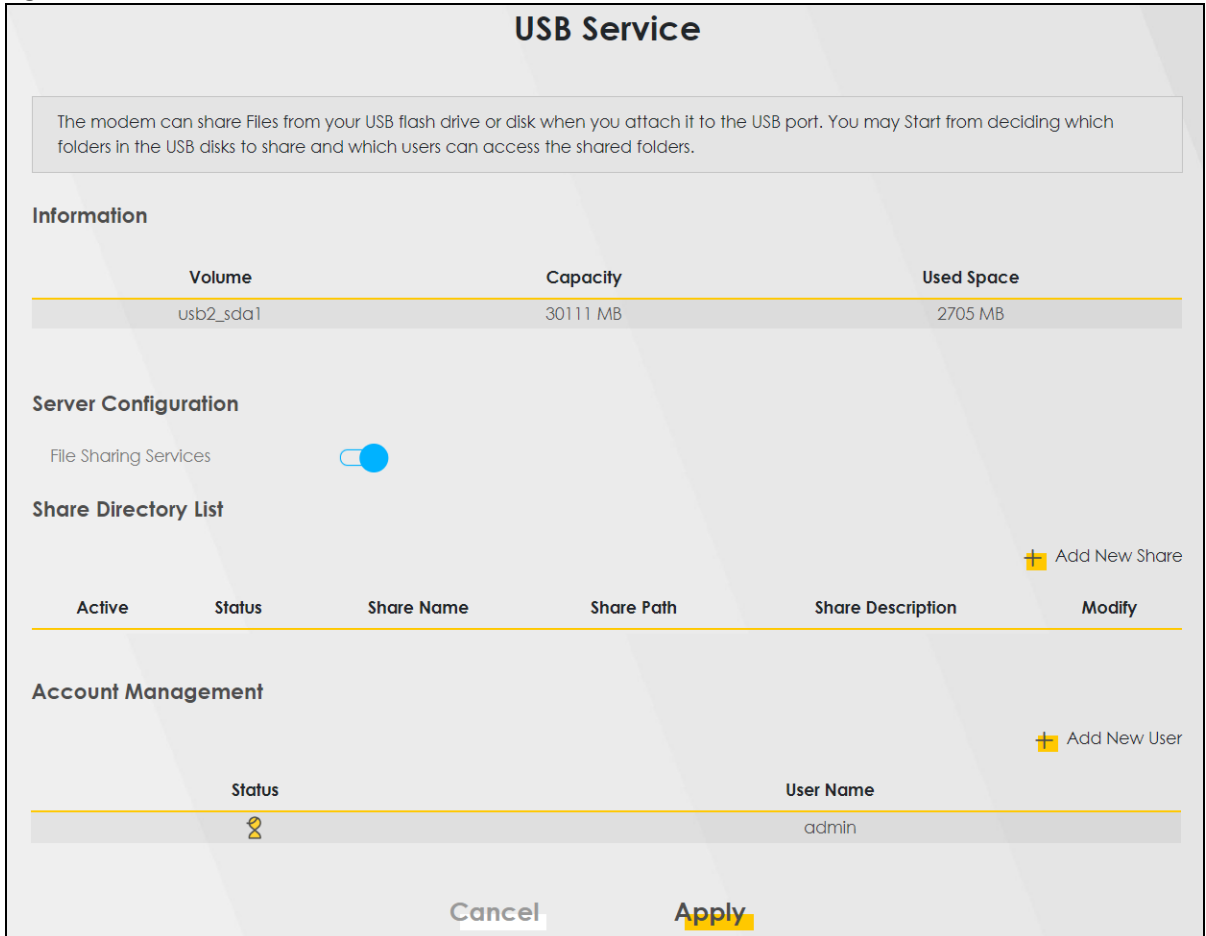



Note: The **Share Directory List** is only visible when you connect a USB device.

Each field is described in the following table.

Table 77 Network Setting > USB Service

LABEL	DESCRIPTION
Information	
Volume	This is the volume name the Zyxel Device gives to an inserted USB device.
Capacity	This is the total available memory size (in megabytes) on the USB device.
Used Space	This is the memory size (in megabytes) already used on the USB device.
Server Configuration	
File Sharing Services	Click this switch to enable file sharing through the Zyxel Device.
Share Directory List	
This only appears when you have inserted a USB device.	
Add New Share	Click this to set up a new share on the Zyxel Device.
Active	Select this to allow the share to be accessed.

Table 77 Network Setting &gt; USB Service (continued)

LABEL	DESCRIPTION
Status	This field shows the status of the share  : The share is not activated.  : The share is activated.
Share Name	This field displays the name of the file you shared.
Share Path	This field displays the location in the USB of the file you shared.
Share Description	This field displays a description of the file you shared.
Modify	Click the <b>Edit</b> icon to change the settings of an existing share. Click the <b>Delete</b> icon to delete this share in the list.
Account Management	
Add New User	Click this button to create a user account to access the secured shares. This button redirects you to <b>Maintenance &gt; User Account</b> .
Status	This field shows the status of the user. : The user account is not activated for the share.  : The user account is activated for the share.
User Name	This is the name of a user who is allowed to access the secured shares on the USB device.
Cancel	Click this to restore your previously saved settings.
Apply	Click this to save your changes to the Zyxel Device.

## 14.2.1 Add New Share

Use this screen to set up a new share or edit an existing share on the Zyxel Device. Click **Add New Share** in the **File Sharing** screen or click the **Edit** or **Modify** icon next to an existing share.

Please note that you need to set up shared folders on the USB device before enabling file sharing in the Zyxel Device. Spaces and the following special characters, [ " ], [ ` ], [ ' ], [ < ], [ > ], [ ^ ], [ \$ ], [ | ], [ & ], [ ; ], are not allowed for the USB share name.



**Figure 148** Network Setting > USB Service > Add New Share

The screenshot shows the 'Add New Share' configuration interface. It includes a back arrow in the top left, a title 'Add New Share', and several input fields: 'Volume' (set to 'usb1\_sda1'), 'Share Path' (with a 'Browse' button), 'Description', and 'Access Level' (set to 'Security'). Below these is a table with two columns: 'Allowed' and 'User Name'. The 'Allowed' column contains an unchecked checkbox, and the 'User Name' column contains the text 'admin'. At the bottom of the screen are 'Cancel' and 'OK' buttons.

The following table describes the labels in this menu.

**Table 78** Network Setting > USB Service > Add New Share

LABEL	DESCRIPTION
Volume	Select the volume in the USB storage device that you want to add as a share in the Zyxel Device. This field is read-only when you are editing the share.
Share Path	Manually enter the file path for the share, or click the <b>Browse</b> button and select the folder that you want to add as a share. This field is read-only when you are editing the share.
Description	You can either enter a short description of the share, or leave this field blank. You can use up to 128 printable characters except [ " ], [ ` ], [ ' ], [ < ], [ > ], [ ^ ], [ \$ ], [   ], [ & ], or [ ; ]. Spaces are allowed.
Access Level	Select <b>Public</b> if you want the share to be accessed by users connecting to the Zyxel Device. Otherwise, select <b>Security</b> .
Allowed	If <b>Security</b> is selected in the <b>Access Level</b> field, select this check box to allow/prohibit access to the share.
User Name	This field specifies the user for which the <b>Allowed</b> setting applies. Users can be added or modified in <b>Maintenance &gt; User Account</b> .
Cancel	Click <b>Cancel</b> to return to the previous screen.
OK	Click <b>OK</b> to save your changes.

## 14.2.2 Add New User Screen

Once you click the **Add New User** button, you will be directed to the **User Account** screen. To create a user account that can access the secured shares on the USB device, click the **Add New Account** button in the **Network Setting > USB Service > User Account** screen.

Please see [Chapter 28 on page 315](#), for detailed information about **User Account** screen.

# CHAPTER 15

## Firewall

### 15.1 Firewall Overview

This chapter shows you how to enable the Zyxel Device firewall. Use the firewall to protect your Zyxel Device and network from attacks by hackers on the Internet and control access to it. The firewall:

- allows traffic that originates from your LAN computers to go to all other networks.
- blocks traffic that originates on other networks from going to the LAN.

By default, the Zyxel Device blocks DoS attacks whether the firewall is enabled or disabled.

The following figure illustrates the firewall action. User **A** can initiate an IM (Instant Messaging) session from the LAN to the WAN (1). Return traffic for this session is also allowed (2). However other traffic initiated from the WAN is blocked (3 and 4).

**Figure 149** Default Firewall Action

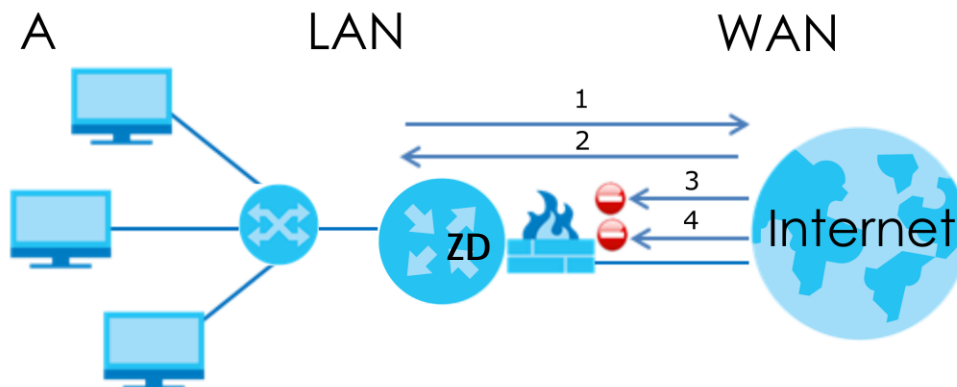

#### 15.1.1 What You Need to Know About Firewall

##### SYN Attack

A SYN attack floods a targeted system with a series of SYN packets. Each packet causes the targeted system to issue a SYN-ACK response. While the targeted system waits for the ACK that follows the SYN-ACK, it queues up all outstanding SYN-ACK responses on a backlog queue. SYN-ACKs are moved off the queue only when an ACK comes back or when an internal timer terminates the three-way handshake. Once the queue is full, the system will ignore all incoming SYN requests, making the system unavailable for legitimate users.

##### DoS

Denial-of-Service (DoS) attacks are aimed at devices and networks with a connection to the Internet. Their goal is not to steal information, but to disable a device or network so users no longer have access

to network resources. The Zyxel Device is pre-configured to automatically detect and thwart all known DoS attacks.

## DoS Thresholds

For DoS attacks, the Zyxel Device uses thresholds to determine when to drop sessions that do not become fully established. These thresholds apply globally to all sessions. You can use the default threshold values, or you can change them to values more suitable to your security requirements.

## DDoS

A Distributed Denial-of-Service (DDoS) attack is one in which multiple compromised systems attack a single target, thereby causing denial of service for users of the targeted system.

## ICMP

Internet Control Message Protocol (ICMP) is a message control and error-reporting protocol between a host server and a gateway to the Internet. ICMP uses Internet Protocol (IP) datagrams, but the messages are processed by the TCP/IP software and directly apparent to the application user.

## LAND Attack

In a LAND attack, hackers flood SYN packets into the network with a spoofed source IP address of the target system. This makes it appear as if the host computer sent the packets to itself, making the system unavailable while the target system tries to respond to itself.

## Ping of Death

Ping of Death uses a 'ping' utility to create and send an IP packet that exceeds the maximum 65,536 bytes of data allowed by the IP specification. This may cause systems to crash, hang or reboot.

## SPI

Stateful Packet Inspection (SPI) tracks each connection crossing the firewall and makes sure it is valid. Filtering decisions are based not only on rules but also context. For example, traffic from the WAN may only be allowed to cross the firewall in response to a request from the LAN.

## 15.2 Firewall

Use the firewall to protect your Zyxel Device and network from attacks by hackers on the Internet and control access to it.

### 15.2.1 What You Can Do in this Chapter

- Use the **General** screen to configure the security level of the firewall on the Zyxel Device ([Section 15.3 on page 236](#)).
- Use the **Protocol** screen to add or remove predefined Internet services and configure firewall rules ([Section 15.4 on page 237](#)).

- Use the **Access Control** screen to view and configure incoming or outgoing filtering rules ([Section 15.5 on page 238](#)).
- Use the **DoS** screen to activate protection against Denial of Service (DoS) attacks ([Section 15.6 on page 241](#)).

## 15.3 Firewall General Settings

Use the firewall to protect your Zyxel Device and network from attacks by hackers on the Internet and control access to it. Use this screen to set the security level of the firewall on the Zyxel Device. Firewall rules are grouped based on the direction of travel of packets. A higher firewall level means more restrictions on the Internet activities you can perform. Click **Security > Firewall > General** to display the following screen. Use the slider to select the level of firewall protection.

**Figure 150** Security > Firewall > General

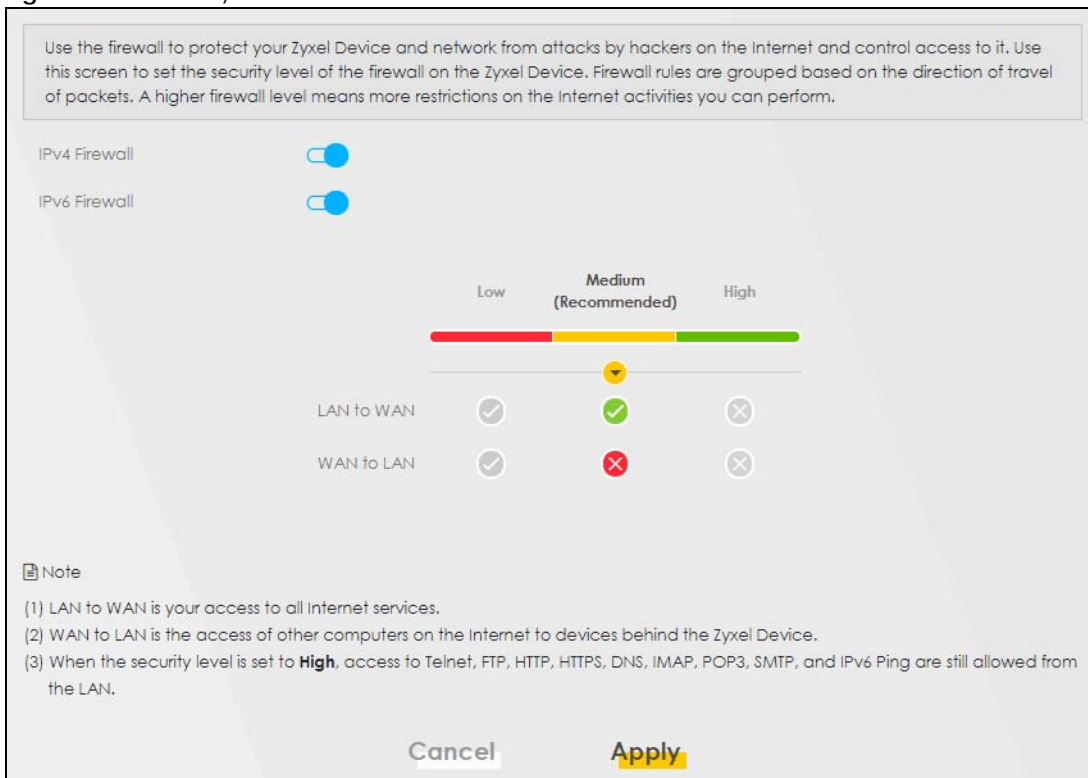

Note: LAN to WAN is your access to all Internet services. WAN to LAN is the access of other computers on the Internet to devices behind the Zyxel Device. When the security level is set to **High**, Telnet, FTP, HTTP, HTTPS, DNS, IMAP, POP3, SMTP, and/or IPv6 ICMPv6 (Ping) traffic from the LAN are still allowed.

The following table describes the labels in this screen.

Table 79 Security > Firewall > General

LABEL	DESCRIPTION
IPv4 Firewall	Enable firewall protection when using <b>IPv4</b> (Internet Protocol version 4).
IPv6 Firewall	Enable firewall protection when using <b>IPv6</b> (Internet Protocol version 6).
High	This setting blocks all traffic to and from the Internet. Only local network traffic and LAN to WAN service (Telnet, FTP, HTTP, HTTPS, DNS, POP3, SMTP) is permitted.
Medium	This is the recommended setting. It allows traffic to the Internet but blocks anyone from the Internet from accessing any services on your local network.
Low	This setting allows traffic to the Internet and also allows someone from the Internet to access services on your local network. This would be used with Port Forwarding, Default Server.
Apply	Click this to save your changes.
Cancel	Click this to restore your previously saved settings.

## 15.4 Protocol (Customized Services)

You can configure customized services and port numbers in the **Protocol** screen. Each set of protocol rules listed in the table are reusable objects to be used in conjunction with ACL rules in the Access Control screen. For a comprehensive list of port numbers and services, visit the IANA (Internet Assigned Number Authority) website. Click **Security > Firewall > Protocol** to display the following screen.

Note: Removing a protocol rule will also remove associated ACL rules.

Figure 151 Security > Firewall > Protocol

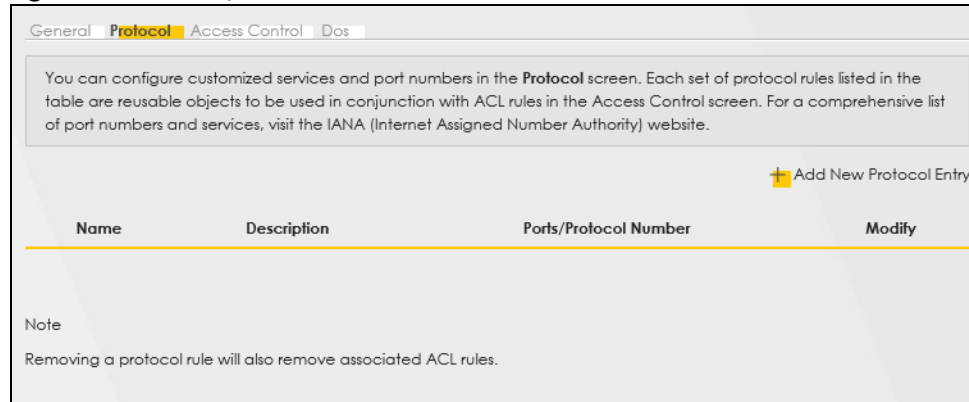

The following table describes the labels in this screen.

Table 80 Security > Firewall > Protocol

LABEL	DESCRIPTION
Add New Protocol Entry	Click this to configure a customized service.
Name	This is the name of your customized service.
Description	This is a description of your customized service.

Table 80 Security &gt; Firewall &gt; Protocol (continued)

LABEL	DESCRIPTION
Ports/Protocol Number	This shows the port number or range and the IP protocol ( <b>TCP</b> or <b>UDP</b> ) that defines your customized service.
Modify	Click this to edit a customized service.

## 15.4.1 Add Customized Service

Add a customized rule or edit an existing rule by specifying the protocol and the port numbers. Click **Add New Protocol Entry** in the **Protocol** screen to display the following screen.

Figure 152 Security &gt; Firewall &gt; Protocol: Add New Protocol Entry

The following table describes the labels in this screen.

Table 81 Security &gt; Firewall &gt; Protocol: Add New Protocol Entry

LABEL	DESCRIPTION
Service Name	Enter a descriptive name for your customized service. You can use up to 16 printable characters except [ " ], [ ` ], [ ' ], [ < ], [ > ], [ ^ ], [ \$ ], [   ], [ & ], or [ ; ]. Spaces are allowed.
Description	Enter a description for your customized service. You can use up to 16 printable characters except [ " ], [ ` ], [ ' ], [ < ], [ > ], [ ^ ], [ \$ ], [   ], [ & ], or [ ; ]. Spaces are allowed.
Protocol	Select the protocol ( <b>TCP</b> , <b>UDP</b> , <b>ICMP</b> , <b>ICMPv6</b> , or <b>Other</b> ) that defines your customized port from the drop down list box.
Protocol Number	Enter a single port number or the range of port numbers ( <b>0 – 255</b> ) that define your customized service.
OK	Click this to save your changes.
Cancel	Click this to exit this screen without saving.

## 15.5 Access Control (Rules)

An Access Control List (ACL) rule is a manually-defined rule that can accept, reject, or drop incoming or outgoing packets from your network. This screen displays a list of the configured incoming or outgoing filtering rules. Note the order in which the rules are listed. Click **Security > Firewall > Access Control** to display the following screen.

Note: The ordering of your rules is very important as rules are applied in turn.

**Figure 153** Security > Firewall > Access Control

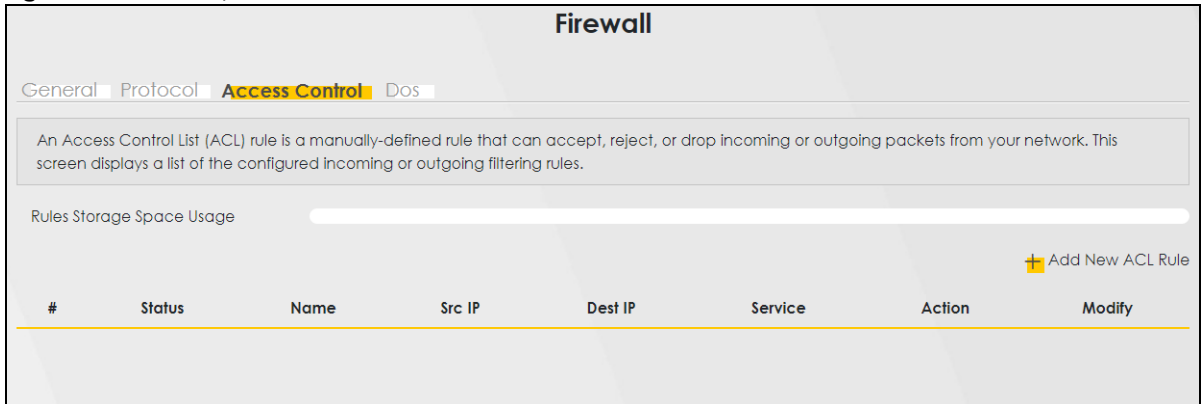

The following table describes the labels in this screen.

**Table 82** Security > Firewall > Access Control

LABEL	DESCRIPTION
Rules Storage Space Usage	This read-only bar shows how much of the Zyxel Device's memory is in use for recording firewall rules. When you are using 80% or less of the storage space, the bar is green. When the amount of space used is over 80%, the bar is red.
Add New ACL Rule	Select an index number and click <b>Add New ACL Rule</b> to add a new firewall rule after the selected index number. For example, if you select "6", your new rule becomes number 7 and the previous rule 7 (if there is one) becomes rule 8.
#	This field displays the rule index number. The ordering of your rules is important as rules are applied in turn.
Name	This field displays the rule name.
Src IP	This field displays the source IP addresses to which this rule applies.
Dest IP	This field displays the destination IP addresses to which this rule applies.
Service	This field displays the protocol (All, TCP, UDP, TCP/UDP, ICMP, ICMPv6, or any) used to transport the packets for which you want to apply the rule.
Action	Displays whether the firewall silently discards packets ( <b>Drop</b> ), discards packets and sends a TCP reset packet or an ICMP destination-unreachable message to the sender ( <b>Reject</b> ), or allow the passage of ( <b>Accept</b> ) packets that match this rule.
Modify	Click the <b>Edit</b> icon to edit the firewall rule.  Click the <b>Delete</b> icon to delete an existing firewall rule.

### 15.5.1 Add New ACL Rule

Click **Add new ACL rule** or the **Edit** icon next to an existing ACL rule in the **Access Control** screen. The following screen displays. Use this screen to accept, reject, or drop packets based on specified parameters, such as source and destination IP address, IP Type, service, and direction. You can also specify a limit as to how many packets this rule applies to at a certain period of time or specify a schedule for this rule.

Figure 154 Security &gt; Firewall &gt; Access Control &gt; Add New ACL Rule

The screenshot shows the 'Add New ACL Rule' configuration interface. It includes the following fields and options:

- Filter Name:** A text input field.
- Order:** A dropdown menu set to '1'.
- Select Source IP Address:** A dropdown menu set to 'Specific IP Address'.
- Source IP Address:** A text input field with a placeholder ' [/prefix length]'.
- Select Destination Device:** A dropdown menu set to 'Specific IP Address'.
- Destination IP Address:** A text input field with a placeholder ' [/prefix length]'.
- IP Type:** A dropdown menu set to 'IPv4'.
- Select Service:** A dropdown menu set to 'Specific Service'.
- Protocol:** A dropdown menu set to 'TCP'.
- Custom Source Port:** A dropdown menu set to 'Range', with input fields for '1' and '1'.
- Custom Destination Port:** A dropdown menu set to 'Range', with input fields for '1' and '1'.
- TCP Flag:** Radio buttons for SYN, ACK, URG, PSH, RST, and FIN.
- Policy:** A dropdown menu set to 'ACCEPT'.
- Direction:** A dropdown menu set to 'WAN to LAN'.

At the bottom, there are 'Cancel' and 'OK' buttons. The 'OK' button is highlighted in yellow.

The following table describes the labels in this screen.

Table 83 Security &gt; Firewall &gt; Access Control &gt; Add New ACL Rule

LABEL	DESCRIPTION
Filter Name	Enter a descriptive name for your filter rule. You can use up to 16 printable characters except [ " ], [ ` ], [ ' ], [ < ], [ > ], [ ^ ], [ \$ ], [   ], [ & ], or [ : ]. Spaces are allowed.
Order	Assign the order of your rules as rules are applied in turn.
Select Source IP Address	If you want the source to come from a particular (single) IP, select <b>Specific IP Address</b> . If not, select from a detected device.
Source IP Address	If you selected <b>Specific IP Address</b> in the previous item, enter the source device's IP address here. Otherwise this field will be hidden if you select the detected device.
Select Destination Device	If you want your rule to apply to packets with a particular (single) IP, select <b>Specific IP Address</b> . If not, select a detected device.
Destination IP Address	If you selected <b>Specific IP Address</b> in the previous item, enter the destination device's IP address here. Otherwise this field will be hidden if you select the detected device.
IP Type	Select between <b>IPv4</b> or <b>IPv6</b> . Compared to <b>IPv4</b> , <b>IPv6</b> (Internet Protocol version 6), is designed to enhance IP address size and features. The increase in <b>IPv6</b> address size to 128 bits (from the 32-bit <b>IPv4</b> address) allows up to 3.4 x 1038 IP addresses. The Zyxel Device can use <b>IPv4/IPv6</b> dual stack to connect to <b>IPv4</b> and <b>IPv6</b> networks, and supports <b>IPv6</b> rapid deployment (6RD).
Select Service	Select a service from the <b>Select Service</b> box.
Protocol	Select the protocol ( <b>ALL</b> , <b>TCP/UDP</b> , <b>TCP</b> , <b>UDP</b> , <b>ICMP</b> , or <b>ICMPv6</b> ) used to transport the packets for which you want to apply the rule.



Table 83 Security &gt; Firewall &gt; Access Control &gt; Add New ACL Rule (continued)

LABEL	DESCRIPTION
Custom Source Port	This is a single port number or the starting port number of a range that defines your rule.
Custom Destination Port	This is a single port number or the ending port number of a range that defines your rule.
TCP Flag	Select the TCP Flag (SYN, ACK, URG, PSH, RST, FIN).  This appears when you select <b>TCP/UDP</b> or <b>TCP</b> in the <b>Protocol</b> field.
Policy	Use the drop-down list box to select whether to discard ( <b>Drop</b> ), deny and send an ICMP destination-unreachable message to the sender ( <b>Reject</b> ), or allow the passage of ( <b>Accept</b> ) packets that match this rule.
Direction	Select <b>WAN to LAN</b> to apply the rule to traffic from WAN to LAN. Select <b>LAN to WAN</b> to apply the rule to traffic from LAN to WAN. Select <b>WAN to Router</b> to apply the rule to traffic from WAN to router. Select <b>LAN to Router</b> to apply the rule to traffic from LAN to router.
OK	Click this to save your changes.
Cancel	Click this to exit this screen without saving.

## 15.6 DoS

DoS (Denial of Service) attacks can flood your Internet connection with invalid packets and connection requests, using so much bandwidth and so many resources that Internet access becomes unavailable. Use the **DoS** screen to activate protection against DoS attacks.

Click **Security > Firewall > DoS** to display the following screen.

Figure 155 Security &gt; Firewall &gt; DoS

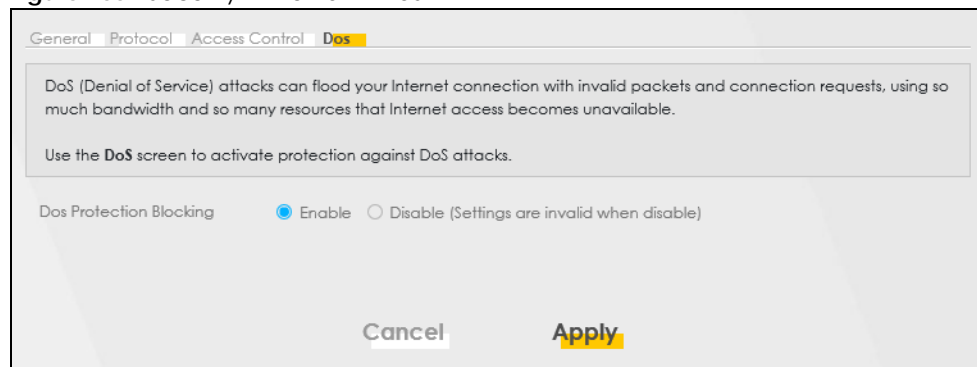

The following table describes the labels in this screen.

Table 84 Security &gt; Firewall &gt; DoS

LABEL	DESCRIPTION
DoS Protection Blocking	Enable this to protect against DoS attacks. The Zyxel Device will drop sessions that surpass maximum thresholds.
Apply	Click this to save your changes.
Cancel	Click this to restore your previously saved settings.

## 15.7 Firewall Technical Reference

This section provides some technical background information about the topics covered in this chapter.

### 15.7.1 Firewall Rules Overview

Your customized rules take precedence and override the Zyxel Device's default settings. The Zyxel Device checks the source IP address, destination IP address and IP protocol type of network traffic against the firewall rules (in the order you list them). When the traffic matches a rule, the Zyxel Device takes the action specified in the rule.

Firewall rules are grouped based on the direction of travel of packets to which they apply:

- LAN to Router
- LAN to WAN
- WAN to LAN
- WAN to Router

By default, the Zyxel Device's stateful packet inspection allows packets traveling in the following directions:

- LAN to Router

These rules specify which computers on the LAN can manage the Zyxel Device (remote management).

Note: You can also configure the remote management settings to allow only a specific computer to manage the Zyxel Device.

- LAN to WAN

These rules specify which computers on the LAN can access which computers or services on the WAN.

By default, the Zyxel Device's stateful packet inspection drops packets traveling in the following directions:

- WAN to LAN

These rules specify which computers on the WAN can access which computers or services on the LAN.

Note: You also need to configure NAT port forwarding (or full featured NAT address mapping rules) to allow computers on the WAN to access devices on the LAN.

- WAN to Router

By default the Zyxel Device stops computers on the WAN from managing the Zyxel Device. You could configure one of these rules to allow a WAN computer to manage the Zyxel Device.

Note: You also need to configure the remote management settings to allow a WAN computer to manage the Zyxel Device.

You may define additional rules and sets or modify existing ones but please exercise extreme caution in doing so.

For example, you may create rules to:

- Block certain types of traffic, such as IRC (Internet Relay Chat), from the LAN to the Internet.
- Allow certain types of traffic, such as Lotus Notes database synchronization, from specific hosts on the Internet to specific hosts on the LAN.
- Allow everyone except your competitors to access a web server.
- Restrict use of certain protocols, such as Telnet, to authorized users on the LAN.

These custom rules work by comparing the source IP address, destination IP address and IP protocol type of network traffic to rules set by the administrator. Your customized rules take precedence and override the Zyxel Device's default rules.

## 15.7.2 Guidelines For Security Enhancement With Your Firewall

- 1 Change the default password through the Web Configurator.
- 2 Think about access control before you connect to the network in any way.
- 3 Limit who can access your router.
- 4 Do not enable any local service (such as telnet or FTP) that you do not use. Any enabled service could present a potential security risk. A determined hacker might be able to find creative ways to misuse the enabled services to access the firewall or the network.
- 5 For local services that are enabled, protect against misuse. Protect by configuring the services to communicate only with specific peers, and protect by configuring rules to block packets for the services at specific interfaces.
- 6 Protect against IP spoofing by making sure the firewall is active.
- 7 Keep the firewall in a secured (locked) room.

## 15.7.3 Security Considerations

Note: Incorrectly configuring the firewall may block valid access or introduce security risks to the Zyxel Device and your protected network. Use caution when creating or deleting firewall rules and test your rules after you configure them.

Consider these security ramifications before creating a rule:

- 1 Does this rule stop LAN users from accessing critical resources on the Internet? For example, if IRC (Internet Relay Chat) is blocked, are there users that require this service?
- 2 Is it possible to modify the rule to be more specific? For example, if IRC is blocked for all users, will a rule that blocks just certain users be more effective?
- 3 Does a rule that allows Internet users access to resources on the LAN create a security vulnerability? For example, if FTP ports (TCP 20, 21) are allowed from the Internet to the LAN, Internet users may be able to connect to computers with running FTP servers.
- 4 Does this rule conflict with any existing rules?

Once these questions have been answered, adding rules is simply a matter of entering the information into the correct fields in the Web Configurator screens.

# CHAPTER 16

## MAC Filter

### 16.1 MAC Filter Overview

You can configure the Zyxel Device to permit access to clients based on their MAC addresses in the **MAC Filter** screen. This applies to wired connections. Every Ethernet device has a unique MAC (Media Access Control) address. The MAC address is assigned at the factory and consists of six pairs of hexadecimal characters, for example, 00:A0:C5:00:00:02. You need to know the MAC addresses of wired LAN client to configure this screen.

### 16.2 MAC Filter

Enable **MAC Address Filter** and add the host name and MAC address of a wired LAN client to the table if you wish to allow or deny them access to your network. You can choose to enable or disable the filters per entry; make sure that the check box under **Active** is selected if you want to use a filter. Select **Security > MAC Filter**. The screen appears as shown.

**Figure 156** Security > MAC Filter

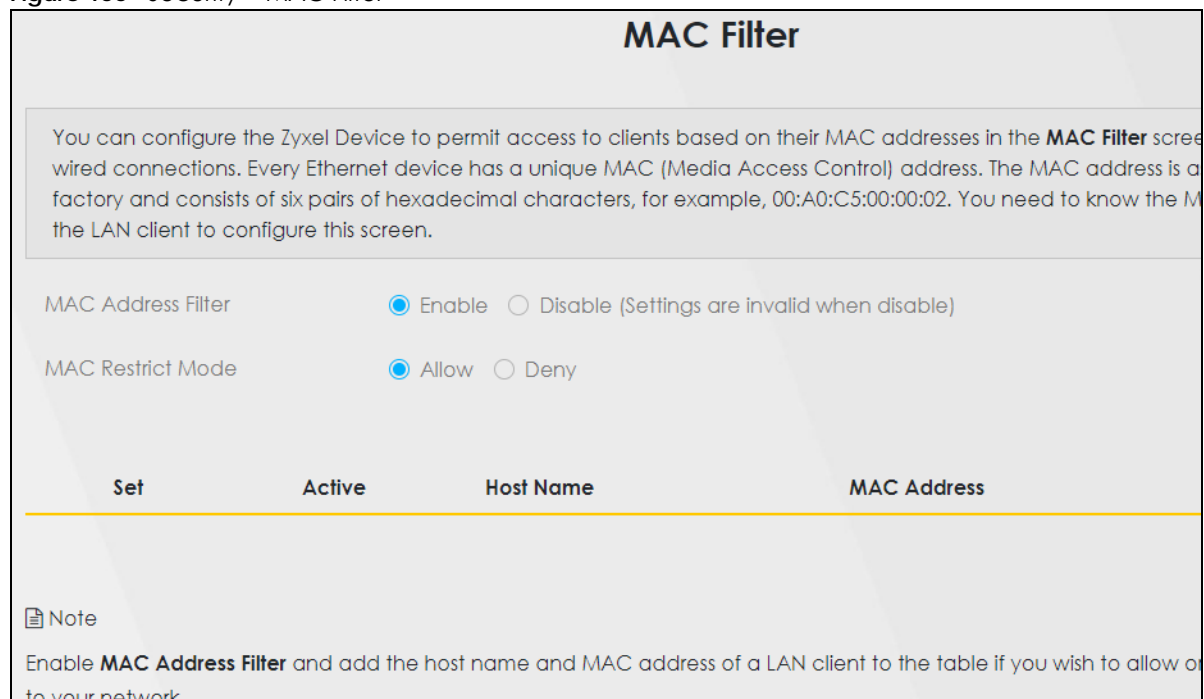

**MAC Filter**

You can configure the Zyxel Device to permit access to clients based on their MAC addresses in the **MAC Filter** screen. This applies to wired connections. Every Ethernet device has a unique MAC (Media Access Control) address. The MAC address is assigned at the factory and consists of six pairs of hexadecimal characters, for example, 00:A0:C5:00:00:02. You need to know the MAC addresses of wired LAN client to configure this screen.

MAC Address Filter  Enable  Disable (Settings are invalid when disable)

MAC Restrict Mode  Allow  Deny

Set	Active	Host Name	MAC Address
-----	--------	-----------	-------------

Note

Enable **MAC Address Filter** and add the host name and MAC address of a LAN client to the table if you wish to allow or to your network.

The following table describes the labels in this screen.

Table 85 Security &gt; MAC Filter

LABEL	DESCRIPTION
MAC Address Filter	Select <b>Enable</b> to activate the MAC filter function.
MAC Restrict Mode	Select <b>Allow</b> to only permit the listed MAC addresses access to the Zyxel Device. Select <b>Deny</b> to permit anyone access to the Zyxel Device except the listed MAC addresses.
Add New Rule	Click the <b>Add</b> button to create a new entry.
Set	This is the index number of the MAC address.
Active	Select <b>Active</b> to enable the MAC filter rule. The rule will not be applied if <b>Allow</b> is not selected under <b>MAC Restrict Mode</b> .
Host Name	Enter the host name of a wired LAN client that you want to allow access to the Zyxel Device. You can use up to 17 printable characters except [ " ], [ ` ], [ ' ], [ < ], [ > ], [ ^ ], [ \$ ], [   ], [ & ], or [ ; ]. Spaces are allowed.
MAC Address	Enter the MAC address of a wired LAN client that you want to allow access to the Zyxel Device. Enter the MAC addresses in a valid MAC address format, that is, six hexadecimal character pairs, for example, 12:34:56:78:9a:bc.
Delete	Click the <b>Delete</b> icon to delete an existing rule.
Cancel	Click <b>Cancel</b> to restore your previously saved settings.
Apply	Click <b>Apply</b> to save your changes.

## 16.2.1 Add New Rule

You can choose to enable or disable the filters per entry; make sure that the check box under **Active** is selected if you want to use a filter, as shown in the example below. Select **Security > MAC Filter > Add New Rule**. The screen appears as shown.

Figure 157 Security &gt; MAC Filter &gt; Add New Rule

Set	Active	Host Name	MAC Address	Delete
1	<input checked="" type="checkbox"/>	test	BC - 22 - 33 - 11 - 66 - AA	
2	<input checked="" type="checkbox"/>	Test	BC - 88 - 99 - 00 - 11 - 24	

The following table describes the labels in this screen.

Table 86 Security &gt; MAC Filter &gt; Add New Rule

LABEL	DESCRIPTION
Set	This is the index number of the MAC address.
Active	Select <b>Active</b> to enable the MAC filter rule. The rule will not be applied if <b>Allow</b> is not selected under <b>MAC Restrict Mode</b> .
Host Name	Enter the host name of a wired LAN client that you want to allow access to the Zyxel Device. You can use up to 17 printable characters except [ " ], [ ` ], [ ' ], [ < ], [ > ], [ ^ ], [ \$ ], [   ], [ & ], or [ ; ]. Spaces are allowed.
MAC Address	Enter the MAC addresses of a wired LAN client that you want to allow access to the Zyxel Device in these address fields. Enter the MAC addresses in a valid MAC address format, that is, six hexadecimal character pairs, for example, 12:34:56:78:9a:bc.
Delete	Click the <b>Delete</b> icon to delete an existing rule.

Table 86 Security > MAC Filter > Add New Rule (continued)

LABEL	DESCRIPTION
Cancel	Click <b>Cancel</b> to restore your previously saved settings.
Apply	Click <b>Apply</b> to save your changes.

# CHAPTER 17

## Parental Control

### 17.1 Parental Control Overview

Parental control allows you to limit the time a user can access the Internet and prevent users from viewing inappropriate content or participating in specified online activities.

### 17.2 Parental Control Schedule and URL Filter

Use this screen to enable parental control and view parental control rules and schedules. You can limit the time a user can access the Internet and prevent users from viewing inappropriate content or participating in specified online activities. These rules are defined in a Parental Control Profile (PCP).

Click **Security > Parental Control** to open the following screen.

**Figure 158** Security > Parental Control

**Parental Control**

Parental control allows you to limit the time a user can access the Internet and prevent users from viewing inappropriate content or participating in specified online activities.

Use this screen to enable parental control and view parental control rules and schedules. You can limit the time a user can access the Internet and prevent users from viewing inappropriate content or participating in specified online activities. These rules are defined in a Parental Control Profile (PCP).

**General**

Parental Control  Enable  Disable (Settings are invalid when disable)

**Parental Control Profile(PCP)**

[+ Add New PCP](#)

#	Status	PCP Name	Home Network User MAC	Internet Access Schedule	Network Service	Website Blocked	Modify
---	--------	----------	-----------------------	--------------------------	-----------------	-----------------	--------

[Cancel](#) [Apply](#)

The following table describes the fields in this screen.

**Table 87** Security > Parental Control

LABEL	DESCRIPTION
General	
Parental Control	Select <b>Enable</b> to activate parental control on the Zyxel Device.



Table 87 Security &gt; Parental Control (continued)

LABEL	DESCRIPTION
Parental Control Profile (PCP)	
Add new PCP	Click this if you want to configure a new Parental Control Profile (PCP).
#	This shows the index number of the rule.
Status	This indicates whether the rule is active or not. A yellow bulb signifies that this rule is active. A gray bulb signifies that this rule is not active.
PCP Name	This shows the name of the rule.
Home Network User MAC	This shows the MAC address of the LAN user's computer to which this rule applies.
Internet Access Schedule	This shows the days and time on which parental control is enabled.
Network Service	This shows whether the network service is configured. If not, <b>None</b> will be shown.
Website Blocked	This shows whether the website block is configured. If not, <b>None</b> will be shown.
Modify	Click the <b>Edit</b> icon to go to the screen where you can edit the rule. Click the <b>Delete</b> icon to delete an existing rule.
Cancel	Click <b>Cancel</b> to restore your previously saved settings.
Apply	Click <b>Apply</b> to save your changes.

## 17.2.1 Add or Edit a Parental Control Profile

Click **Add new PCP** in the **Parental Control** screen to add a new rule or click the **Edit** icon next to an existing rule to edit it. Use this screen to configure a restricted access schedule and/or URL filtering settings to block the users on your network from accessing certain web sites.

Figure 159 Security > Parental Control > Add or Edit PCP (General, Rule List & Internet Access Schedule)

### Add New PCP

---

#### General

Active  Enable  Disable (Settings are invalid when disable)

Parental Control Profile Name

Home Network User

---

#### Rule List

User MAC Address	Delete
------------------	--------

---

#### Internet Access Schedule

Day  Mon  Tue  Wed  Thu  Fri  Sat  Sun

Add New Time

Time (Start-End)

**Figure 160** Security > Parental Control > Add or Edit PCP (Network Service & Site/URL Keyword)

The screenshot shows the configuration interface for adding or editing a Parental Control Profile (PCP). It is split into two main sections: 'Network Service' and 'Site/URL Keyword'.  
 In the 'Network Service' section, there is a dropdown menu labeled 'Network Service Setting' currently set to 'Block'. To its right is a label 'Selected Service(s)'. Below this is a table with columns: '#', 'Service Name', 'Protocol:Port', and 'Modify'. An '+ Add New Service' button is located to the right of the table.  
 In the 'Site/URL Keyword' section, there is a dropdown menu labeled 'Block or Allow the Web Site' currently set to 'Block the web URLs'. To its right is an '+ Add' button. Below this is a table with columns: '#', 'Website', and 'Modify'.  
 At the bottom of the screen are 'Cancel' and 'OK' buttons.

The following table describes the fields in this screen.

**Table 88** Security > Parental Control > Add or Edit PCP

LABEL	DESCRIPTION
General	
Active	Select <b>Enable</b> or <b>Disable</b> to activate or deactivate the parental control rule.
Parental Control Profile Name	Enter a descriptive name for the profile. You can use up to 17 printable characters except [ " ], [ ` ], [ ' ], [ < ], [ > ], [ ^ ], [ \$ ], [   ], [ & ], or [ ; ]. Spaces are allowed.
Home Network User	Select the LAN user that you want to apply this rule to from the drop-down list box. If you select <b>Custom</b> , enter the LAN user's MAC address. If you select <b>All</b> , the rule applies to all LAN users.
Rule List	In <b>Home Network User</b> , select <b>Custom</b> , enter the LAN user's MAC address, then click the <b>Add</b> icon to enter a computer MAC address for this PCP. Up to five are allowed. Click the <b>Delete</b> icon to remove one.
Internet Access Schedule	
Day	Select check boxes for the days that you want the Zyxel Device to perform parental control.
Time (Start-End)	Drag the time bar to define the time that the LAN user is allowed access ( <b>Authorized access</b> ) or denied access ( <b>No access</b> ).
Add New Time	Click this to add a new time bar. Up to three are allowed.
Network Service	
Network Service Setting	If you select <b>Block</b> , the Zyxel Device prohibits the users from viewing the web sites with the URLs listed below. If you select <b>Allow</b> , the Zyxel Device blocks access to all URLs except ones listed below.
Add New Service	Click this to show a screen in which you can add a new service rule. You can configure the <b>Service Name</b> , <b>Protocol</b> , and <b>Port</b> of the new rule, as shown in <a href="#">Figure 161</a> .
#	This shows the index number of the rule.
Service Name	This shows the name of the rule.
Protocol:Port	This shows the protocol and the port of the rule.

**Table 88** Security > Parental Control > Add or Edit PCP (continued)

LABEL	DESCRIPTION
Modify	Click the <b>Edit</b> icon to go to the screen where you can edit the rule. Click the <b>Delete</b> icon to delete an existing rule.
Site/URL Keyword	
Block or Allow the Web Site	If you select <b>Block the Web URLs</b> , the Zyxel Device prohibits the users from viewing the Web sites with the URLs listed below.  If you select <b>Allow the Web URLs</b> , the Zyxel Device blocks access to all URLs except ones listed below.
Add	Click <b>Add</b> to show a screen to enter the URL of web site or URL keyword to which the Zyxel Device blocks or allows access.
#	This shows the index number of the rule.
Website	This shows the URL of web site or URL keyword to which the Zyxel Device blocks or allows access.
Modify	Click the <b>Edit</b> icon to go to the screen where you can edit the rule. Click the <b>Delete</b> icon to delete an existing rule.
Cancel	Click <b>Cancel</b> to exit this screen without saving any changes.
OK	Click <b>OK</b> to save your changes.

## Add New Service

Use this screen to add a new service rule.

**Figure 161** Security > Parental Control > Add or Edit PCP > Add New Service

The following table describes the fields in this screen.

**Table 89** Security > Parental Control > Add or Edit PCP > Add New Service

LABEL	DESCRIPTION
Add New Service	Select the name of the service from the drop-down list. Otherwise, select <b>User Define</b> and specify the name, protocol, and port of the service.  If you have chosen a pre-defined service in the <b>Service Name</b> field, this field will not be configurable.
Protocol	Select the transport layer protocol used for the service. Choices are <b>TCP</b> , <b>UDP</b> , or <b>TCP &amp; UDP</b> .
Port	Enter the port of the service.  If you have chosen a pre-defined service in the <b>Service Name</b> field, this field will not be configurable.

Table 89 Security &gt; Parental Control &gt; Add or Edit PCP &gt; Add New Service (continued)

LABEL	DESCRIPTION
Cancel	Click <b>Cancel</b> to exit this screen without saving any changes.
OK	Click <b>OK</b> to save your changes.

## Add Site/URL Keyword

Click **Add** in the **Site/URL Keyword** section of the **Edit** or **Add new PCP** screen to open the following screen.

Note: Do not include "HTTP" or "HTTPS" in the keyword. HTTPS connections cannot be blocked by Parental Control.

Figure 162 Security &gt; Parental Control &gt; Add or Edit PCP &gt; Add Keyword

The following table describes the fields in this screen.

Table 90 Security &gt; Parental Control &gt; Add or Edit PCP &gt; Add Keyword

LABEL	DESCRIPTION
Site/URL Keyword	Enter a keyword and click <b>OK</b> to have the Zyxel Device block access to the website URLs that contain the keyword.
Cancel	Click <b>Cancel</b> to exit this screen without saving any changes.
OK	Click <b>OK</b> to save your changes.

# CHAPTER 18

## Certificates

### 18.1 Certificates Overview

The Zyxel Device can use certificates (also called digital IDs) to authenticate users. Certificates are based on public-private key pairs. A certificate contains the certificate owner's identity and public key. Certificates provide a way to exchange public keys for use in authentication.

#### 18.1.1 What You Can Do in this Chapter

- Use the **Local Certificates** screen to view and import the Zyxel Device's CA-signed (Certification Authority) certificates ([Section 18.3 on page 254](#)).
- Use the **Trusted CA** screen to save the certificates of trusted CAs to the Zyxel Device. You can also export the certificates to a computer ([Section 18.4 on page 258](#)).

### 18.2 What You Need to Know

The following terms and concepts may help as you read through this chapter.

#### Certification Authority

A Certification Authority (CA) issues certificates and guarantees the identity of each certificate owner. There are commercial certification authorities like CyberTrust or VeriSign and government certification authorities. The certification authority uses its private key to sign certificates. Anyone can then use the certification authority's public key to verify the certificates. You can use the Zyxel Device to generate certification requests that contain identifying information and public keys and then send the certification requests to a certification authority.

### 18.3 Local Certificates

Use this screen to view the Zyxel Device's summary list of certificates, generate certification requests, and import signed certificates. You can import the following certificates to your Zyxel Device:

- Web Server – This certificate secures HTTP connections.
- SSH – This certificate secures remote connections.

Click **Security > Certificates** to open the **Local Certificates** screen.

Figure 163 Security &gt; Certificates &gt; Local Certificates

**Certificates**

**Local Certificates** Trusted CA

View the Zyxel Device's summary list of certificates, generate certification requests, and import the signed certificates.

Replace PrivateKey/Certificate file in PEM format

Private Key is protected by password

Choose File No file chosen

Current File	Subject	Issuer	Valid From	Valid To	Modify
--------------	---------	--------	------------	----------	--------

The following table describes the labels in this screen.

Table 91 Security &gt; Certificates &gt; Local Certificates

LABEL	DESCRIPTION
Replace Private Key/Certificate file in PEM format	
Private Key is protected by password	Select the check box and enter the private key into the text box to store it on the Zyxel Device. You can use up to 63 alphanumeric (0-9, a-z, A-Z) and special characters, including spaces.
Choose File/Browse	Click this button to find the certificate file you want to upload.
Import Certificate	Click this button to save the certificate that you have enrolled from a certification authority from your computer to the Zyxel Device.
Create Certificate Request	Click this button to go to the screen where you can have the Zyxel Device generate a certification request.
Current File	This field displays the name used to identify this certificate. It is recommended that you give each certificate a unique name.
Subject	This field displays identifying information about the certificate's owner, such as <b>CN</b> (Common Name), <b>OU</b> (Organizational Unit or department), <b>O</b> (Organization or company) and <b>C</b> (Country). It is recommended that each certificate have a unique subject information.
Issuer	This field displays identifying information about the certificate's issuing certification authority, such as a common name, organizational unit or department, organization or company and country.
Valid From	This field displays the date that the certificate becomes applicable. The text displays in red and includes a <b>Not Yet Valid!</b> message if the certificate has not yet become applicable.
Valid To	This field displays the date that the certificate expires. The text displays in red and includes an <b>Expiring!</b> or <b>Expired!</b> message if the certificate is about to expire or has already expired.
Modify	Click the <b>View</b> icon to open a screen with an in-depth list of information about the certificate.  For a certification request, click <b>Load Signed</b> to import the signed certificate.  Click the <b>Remove</b> icon to remove the certificate (or certification request). A window displays asking you to confirm that you want to delete the certificate. Note that subsequent certificates move up by one when you take this action.

## 18.3.1 Create Certificate Request

Click **Security > Certificates > Local Certificates** and then **Create Certificate Request** to open the following screen. Use this screen to have the Zyxel Device generate a certification request. To create a certificate signing request, you need to enter a common name, organization name, state or province name, and the default US two-letter country code (The US country code is by default and not changeable when sold in the U.S.) for the certificate.

**Figure 164** Security > Certificates > Local Certificates: Create Certificate Request

The following table describes the labels in this screen.

**Table 92** Security > Certificates > Local Certificates: Create Certificate Request

LABEL	DESCRIPTION
Certificate Name	Enter a descriptive name to identify this certificate. You can use up to 63 printable characters except [ " ], [ ` ], [ ' ], [ < ], [ > ], [ ^ ], [ \$ ], [   ], [ & ], or [ ; ]. Spaces are allowed.
Common Name	Select <b>Auto</b> to have the Zyxel Device configure this field automatically. Or select <b>Customize</b> to enter it manually.  Enter the IP address (in dotted decimal notation), domain name or email address in the field provided. You can use up to 63 printable characters except [ " ], [ ` ], [ ' ], [ < ], [ > ], [ ^ ], [ \$ ], [   ], [ & ], or [ ; ]. Spaces are allowed. The domain name or email address is for identification purposes only and can be any string.
Organization Name	Enter a descriptive name to identify the company or group to which the certificate owner belongs. You can use up to 32 printable characters except [ " ], [ ` ], [ ' ], [ < ], [ > ], [ ^ ], [ \$ ], [   ], [ & ], or [ ; ]. Spaces are allowed.
State/Province Name	Enter a descriptive name to identify the state or province where the certificate owner is located. You can use up to 32 printable characters except [ " ], [ ` ], [ ' ], [ < ], [ > ], [ ^ ], [ \$ ], [   ], [ & ], or [ ; ]. Spaces are allowed.
Country/Region Name	Select a country to identify the nation where the certificate owner is located.
Cancel	Click <b>Cancel</b> to exit this screen without saving.
OK	Click <b>OK</b> to save your changes.



## 18.3.2 View Certificate Request

Use this screen to view in-depth information about the certificate request. The **Certificate** is used to verify the authenticity of the certification authority. The **Private Key** serves as your digital signature for authentication and must be safely stored. The **Signing Request** contains the certificate signing request value that you will copy upon submitting the certificate request to the CA (certificate authority).

Click the **View** icon in the **Local Certificates** screen to open the following screen.

**Figure 165** Security > Certificates > Local Certificates: View Certificate

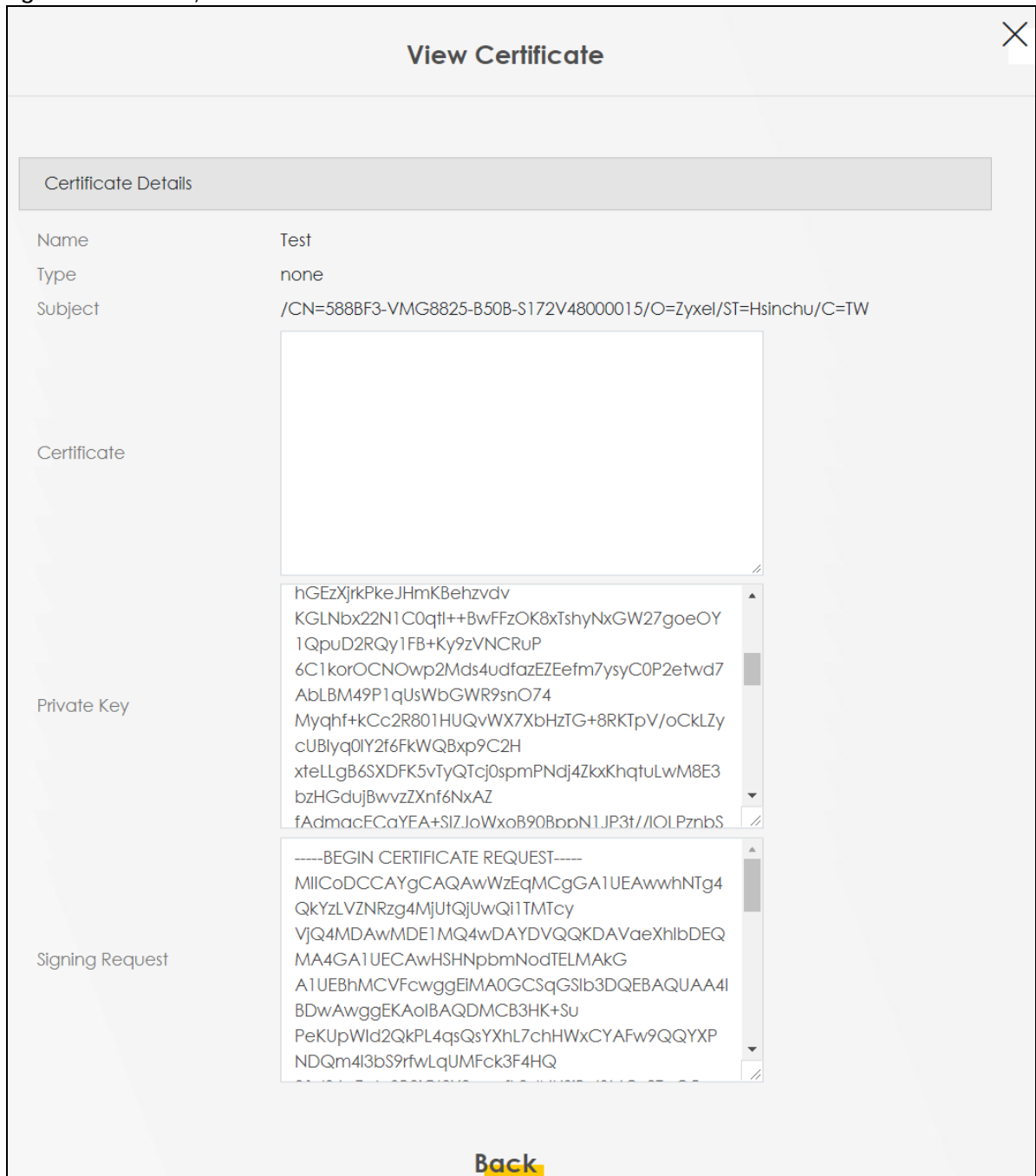

The following table describes the fields in this screen.

Table 93 Security > Certificates > Local Certificates: View Certificates

LABEL	DESCRIPTION
Name	This field displays the identifying name of this certificate.
Type	This field displays general information about the certificate. <b>ca</b> means that a Certification Authority signed the certificate.
Subject	This field displays information that identifies the owner of the certificate, such as Common Name (CN), Organizational Unit (OU), Organization (O) and Country (C).
Certificate	This read-only text box displays the certificate in Privacy Enhanced Mail (PEM) format. PEM uses base 64 to convert the binary certificate into a printable form.  You can copy and paste the certificate into an email to send to friends or colleagues or you can copy and paste the certificate into a text editor and save the file on a management computer for later distribution.
Private Key	This field displays the private key of this certificate.
Signing Request	This field displays the CSR (Certificate Signing Request) information of this certificate. The CSR will be provided to a certificate authority, and it includes information about the public key, organization name, domain name, location, and country of this certificate.
Back	Click <b>Back</b> to return to the previous screen.

## 18.4 Trusted CA

Click **Security > Certificates > Trusted CA** to open the following screen. This screen displays a summary list of certificates of the certification authorities that you have set the Zyxel Device to accept as trusted. The Zyxel Device accepts any valid certificate signed by a certification authority on this list as being trustworthy, which means you do not need to import any certificate that is signed by one of these certification authorities.

Note: A maximum of ten certificates can be added.

Figure 166 Security > Certificates > Trusted CA

**Certificates**

Local Certificates **Trusted CA**

This screen displays a summary list of certificates of the certification authorities that you have set the Zyxel Device to accept as trusted. The Zyxel Device accepts any valid certificate signed by a certification authority on this list as being trustworthy; thus you do not need to import any certificate that is signed by one of these certification authorities.

+ Import Certificate

#	Name	Subject	Type	Modify
---	------	---------	------	--------

Note  
Maximum of 10 certificates

The following table describes the labels in this screen.

Table 94 Security > Certificates > Trusted CA

LABEL	DESCRIPTION
Import Certificate	Click this to open a screen where you can save the certificate of a certification authority that you trust to the Zyxel Device.
#	This is the index number of the entry.
Name	This field displays the name used to identify this certificate.
Subject	This field displays information that identifies the owner of the certificate, such as Common Name (CN), OU (Organizational Unit or department), Organization (O), State (ST) and Country (C). It is recommended that each certificate have a unique subject information.
Type	This field displays general information about the certificate. <b>ca</b> means that a Certification Authority signed the certificate.
Modify	Click the <b>View</b> icon to open a screen with an in-depth list of information about the certificate (or certification request).  Click the <b>Remove</b> icon to delete the certificate (or certification request). You cannot delete a certificate that one or more features is configured to use.

## 18.5 Import Trusted CA Certificate

Click **Import Certificate** in the **Trusted CA** screen to open the **Import Certificate** screen. The Zyxel Device trusts any valid certificate signed by any of the imported trusted CA certificates. Certificates should be in one of the following formats: Binary X.509, PEM (base-64) encoded, Binary PKCS#7, or PEM (base-64) encoded PKCS#7.

Note: You must remove any spaces from the certificate's filename before you can import the certificate.

Figure 167 Security > Certificates > Trusted CA > Import Certificate

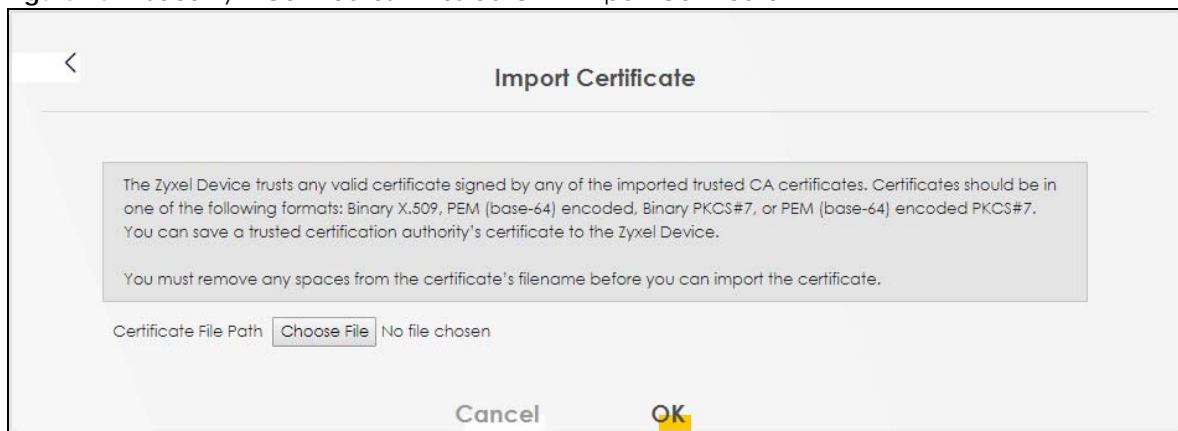

The following table describes the labels in this screen.

Table 95 Security > Certificates > Trusted CA > Import Certificate

LABEL	DESCRIPTION
Certificate File Path	Enter the location of the file you want to upload in this field or click <b>Choose File/Browse</b> to find it.
Choose File/Browse	Click this to find the certificate file you want to upload.
OK	Click this to save the certificate on the Zyxel Device.
Cancel	Click this to exit this screen without saving.

## 18.6 View Trusted CA Certificate

Use this screen to view in-depth information about the certification authority's certificate. The certificate text box is read-only and can be distributed to others.

Click **Security > Certificates > Trusted CA** to open the **Trusted CA** screen. Click the **View** icon to open the **View Certificate** screen.

Figure 168 Security > Certificates > Trusted CA > View Certificate

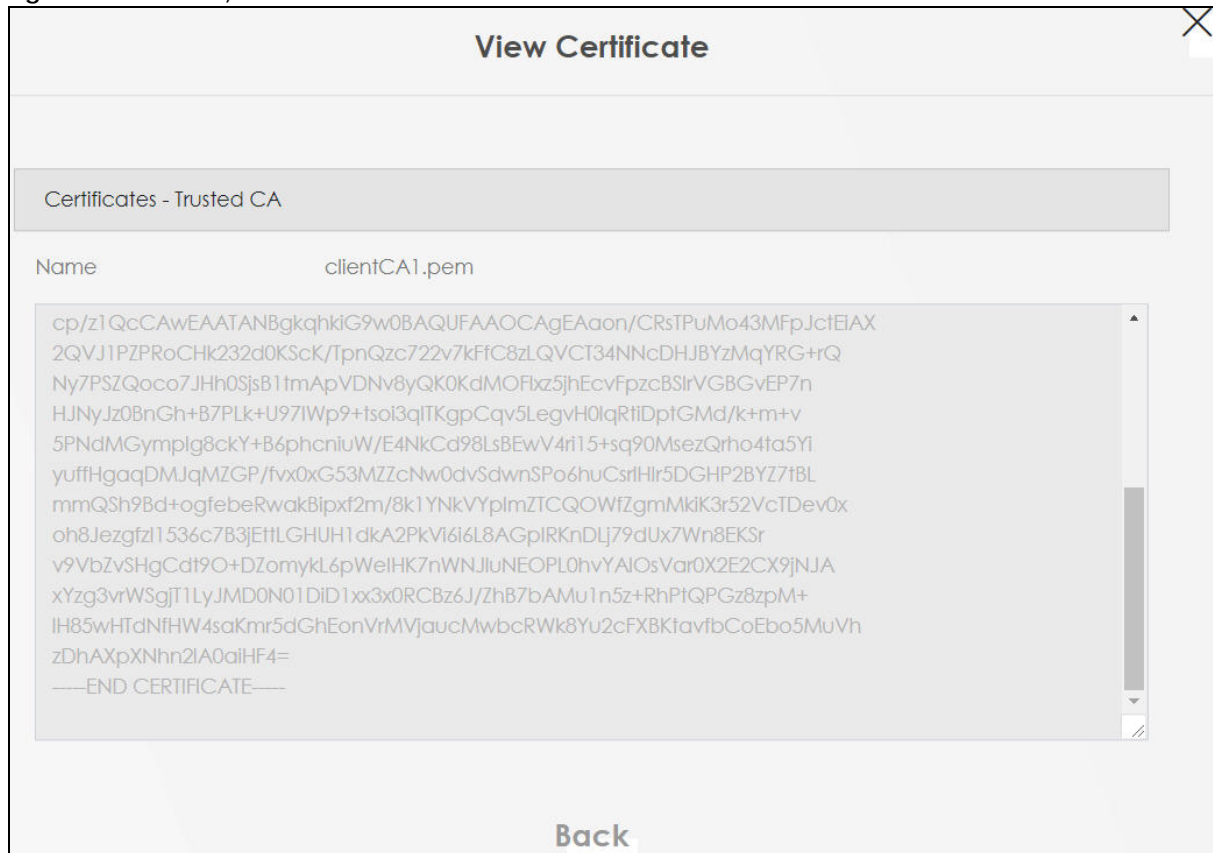

The following table describes the labels in this screen.

Table 96 Security > Certificates > Trusted CA > View Certificate

LABEL	DESCRIPTION
Name	This field displays the identifying name of this certificate.
	<p>This read-only text box displays the certificate or certification request in Privacy Enhanced Mail (PEM) format. PEM uses 64 ASCII characters to convert the binary certificate into a printable form.</p> <p>You can copy and paste the certificate into an email to send to friends or colleagues or you can copy and paste the certificate into a text editor and save the file on a management computer for later distribution (through USB thumb drive for example).</p>
Back	Click this to return to the previous screen.

## 18.7 Certificates Technical Reference

This section provides some technical background information about the topics covered in this chapter.

### Certification Authorities

A Certification Authority (CA) issues certificates and guarantees the identity of each certificate owner. There are commercial certification authorities like CyberTrust or VeriSign and government certification authorities.

### Public and Private Keys

When using public-key cryptology for authentication, each host has two keys. One key is public and can be made openly available; the other key is private and must be kept secure. Public-key encryption in general works as follows.

- 1 Tim wants to send a private message to Jenny. Tim generates a public-private key pair. What is encrypted with one key can only be decrypted using the other.
- 2 Tim keeps the private key and makes the public key openly available.
- 3 Tim uses his private key to encrypt the message and sends it to Jenny.
- 4 Jenny receives the message and uses Tim's public key to decrypt it.
- 5 Additionally, Jenny uses her own private key to encrypt a message and Tim uses Jenny's public key to decrypt the message.

The Zyxel Device uses certificates based on public-key cryptology to authenticate users attempting to establish a connection. The method used to secure the data that you send through an established connection depends on the type of connection. For example, a VPN tunnel might use the triple DES encryption algorithm.

The certification authority uses its private key to sign certificates. Anyone can then use the certification authority's public key to verify the certificates.

## Advantages of Certificates

Certificates offer the following benefits.

- The Zyxel Device only has to store the certificates of the certification authorities that you decide to trust, no matter how many devices you need to authenticate.
- Key distribution is simple and very secure since you can freely distribute public keys and you never need to transmit private keys.

## Certificate File Format

The certification authority certificate that you want to import has to be in PEM (Base-64) encoded X.509 file format. This Privacy Enhanced Mail format uses 64 ASCII characters to convert a binary X.509 certificate into a printable form.

### 18.7.1 Verify a Certificate

Before you import a trusted CA or trusted remote host certificate into the Zyxel Device, you should verify that you have the actual certificate. This is especially true of trusted CA certificates since the Zyxel Device also trusts any valid certificate signed by any of the imported trusted CA certificates.

You can use a certificate's fingerprint to verify it. A certificate's fingerprint is a message digest calculated using the MD5 or SHA1 algorithms. The following procedure describes how to check a certificate's fingerprint to verify that you have the actual certificate.

- 1 Browse to where you have the certificate saved on your computer.
- 2 Make sure that the certificate has a ".cer" or ".crt" file name extension.

**Figure 169** Certificates on Your Computer



- 3 Double-click the certificate's icon to open the **Certificate** window. Click the **Details** tab and scroll down to the **Thumbprint Algorithm** and **Thumbprint** fields.

Figure 170 Certificate Details

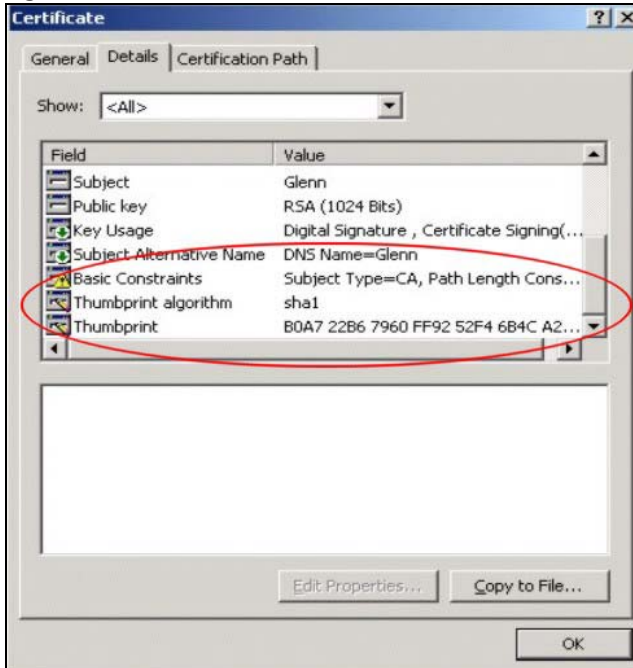

Use a secure method to verify that the certificate owner has the same information in the **Thumbprint Algorithm** and **Thumbprint** fields. The secure method may vary based on your situation. Possible examples would be over the telephone or through an HTTPS connection.

# CHAPTER 19

## Voice

### 19.1 Voice Overview

You can make calls over the Internet using VoIP technology. For this, you first need to set up a SIP account with a SIP service provider.

Use this chapter to:

- Connect an analog phone to the Zyxel Device.
- Configure settings such as speed dial.
- Configure network settings to optimize the voice quality of your phone calls.

5G only supports all-IP based packet-switched telephony services. When Voice service is enabled, the Zyxel Device supports Circuit Switched FallBack (CSFB) to deliver or receive circuit-switched voice calls and text messages through a 3G mobile network and then goes back to the 5G network to transmit data packets.

With the voice service, users do not need a SIP account and SIP server to make phone calls over the Internet.

#### 19.1.1 What You Can Do in this Chapter

These screens allow you to configure your Zyxel Device to make phone calls over the Internet and your regular phone line, and to set up the phone you connect to the Zyxel Device.

- Use the **Voice Mode** screen to enable VoIP or VoLTE services on the Zyxel Device ([Section 19.2 on page 265](#)).
- Use the **SIP Account** screen to set up information about your SIP account, control which SIP accounts the phones connected to the Zyxel Device use, and configure audio settings such as volume levels for the phones connected to the Zyxel Device ([Section 19.4 on page 266](#)).
- Use the **SIP Service Provider** screen to configure the SIP server information, and the numbers for certain phone functions ([Section 19.5 on page 270](#)).
- Use the **Phone** screens to change settings that depend on which region of the world the Zyxel Device is in ([Section 19.6 on page 274](#)).
- Use the **Call Rule** screen to set up shortcuts for dialing frequently-used (VoIP) phone numbers ([Section 19.8 on page 276](#)).
- Use the **Call History** screen to view a call history list ([Section 19.9 on page 277](#)).



## 19.2 Voice Mode

Use this screen to enable VoIP or VoLTE services on the Zyxel Device. To access this screen, click **Voice > Voice Mode**.

**Figure 171** Voice > Voice Mode

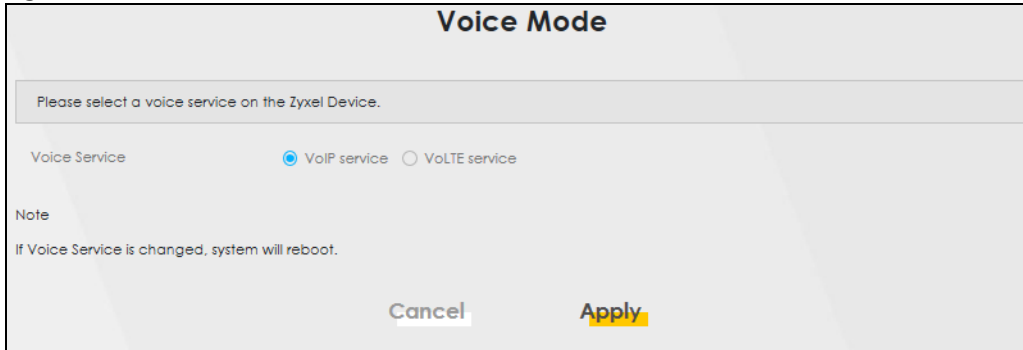

The following table describes the labels in this screen.

Table 97 Voice > Voice Mode

LABEL	DESCRIPTION
Configuration	
Voice Service	Select <b>Enable</b> to activate VoIP or VoLTE on the Zyxel Device.
Apply	Click <b>Apply</b> to save the settings.
Cancel	Click <b>Cancel</b> to start configuring this screen again.

### 19.2.1 What You Need to Know About VoIP

#### VoIP

VoIP stands for Voice over IP. IP is the Internet Protocol, which is the message-carrying standard the Internet runs on. So, Voice over IP is the sending of voice signals (speech) over the Internet (or another network that uses the Internet Protocol).

#### SIP

SIP stands for Session Initiation Protocol. SIP is a signaling standard that lets one network device (like a computer or the Zyxel Device) send messages to another. In VoIP, these messages are about phone calls over the network. For example, when you dial a number on your Zyxel Device, it sends a SIP message over the network asking the other device (the number you dialed) to take part in the call. To access this screen, click **VoiceVoIP > SIP**.

#### SIP Accounts

A SIP account is a type of VoIP account. It is an arrangement with a service provider that lets you make phone calls over the Internet. When you set the Zyxel Device to use your SIP account to make calls, the Zyxel Device is able to send all the information about the phone call to your service provider on the Internet.

Strictly speaking, you do not need a SIP account. It is possible for one SIP device (like the Zyxel Device) to call another without involving a SIP service provider. However, the networking difficulties involved in doing this make it tremendously impractical under normal circumstances. Your SIP account provider removes these difficulties by taking care of the call routing and setup – figuring out how to get your call to the right place in a way that you and the other person can talk to one another.

## SIP Address

A SIP address is a URI (Uniform Resource Identifier) that resembles an email address, using the format: user@domain. It uniquely identifies a telephone extension over a VoIP system. A SIP address of 123-45-67@voip-provider.net tells a client to connect to voip-provider.net and request a connection to 123-45-67. While VoIP can only send voice messages over the Internet, SIP (though strictly speaking is a type of VoIP) can send voice, data, video, and other media. VoIP phones also need to be connected to a computer to function, whereas SIP phones only need to be connected to a modem.

## 19.3 Before You Begin

- Before you can use these screens, you need to have a VoIP account already set up. If you do not have one yet, you can sign up with a VoIP service provider over the Internet.
- You should have the information your VoIP service provider gave you ready, before you start to configure the Zyxel Device.

## 19.4 SIP Account

You can make calls over the Internet using VoIP technology. For this, you first need to set up a SIP account with a SIP service provider. The Zyxel Device uses a SIP account to make outgoing VoIP calls, and to check if an incoming call's destination number matches your SIP account's VoIP number. In order to make and receive VoIP calls, you need to enable and configure a SIP account, and then map it to a phone port. The SIP account contains information that allows your Zyxel Device to connect to your VoIP service provider.

To access this screen, click **Voice > SIP > SIP Account**.

**Figure 172** Voice > SIP > SIP Account

SIP					
SIP Account SIP Service Provider					
In order to make Internet phone calls, a valid SIP account is essential. You may need to consult your SIP service provider for the following settings. This configuration should be used in conjunction with SIP Service Provider.					
#	Enable	SIP Account	Service Provider	Account Number	Modify
1	Disabled	SIP1	ChangeMe	ChangeMe	

The following table describes the labels in this screen.

Table 98 Voice > SIP > SIP Account

LABEL	DESCRIPTION
#	This is the index number of the entry.
Enable	This shows whether the SIP account is activated or not. A yellow bulb signifies that this SIP account is activated. A gray bulb signifies that this SIP account is activated.
SIP Account	This shows the name of the SIP account.
Service Provider	This shows the name of the SIP service provider.
Account Number	This shows the SIP number.
Modify	Click the <b>Modify</b> icon to configure the SIP account.

### 19.4.1 SIP Account Entry Edit

You can configure an SIP account. To access this screen, click the **Modify** icon.

Note: You do not necessarily need to use all these fields to set up your account.

**Figure 173** Voice > SIP > SIP Account > SIP Account Entry Edit

**SIP Account Entry Edit**

**SIP Account Selection**  
SIP Account Selection SIP1

**SIP Service Provider Association**  
SIP Account Associated with ChangeMe

**General**  
 Enable SIP Account  
SIP Account Number ChangeMe

**Authentication**  
Username ChangeMe  
Password \*\*\*\*\*

**URL Type**  
URL Type SIP

**Voice Features**  
Primary Compression Type G.711u  
Secondary Compression Type G.729  
Third Compression Type G.711a  
Speaking Volume Control Middle  
Listening Volume Control Middle  
 Enable G.168 (Echo Cancellation)  
 Enable VAD (Voice Active Detector)

**Call Features**  
 Send Caller ID  
 Enable Call Waiting  
Call Waiting Reject Timer 20 (10~60) second  
 Enable Do Not Disturb (DND)

**Warning:**  
If you enable this item, you will not get indication when somebody call you.

Active Incoming Anonymous Call Block

Cancel OK

The following table describes the labels in this screen.

**Table 99** Voice > SIP > SIP Account > SIP Account Entry Edit

LABEL	DESCRIPTION
SIP Service Provider Association	
SIP Service Provider Associated with	Select the check box to use this account. Clear it to not use this account.
General	
SIP Account Number	Enter your SIP number. In the full SIP URI, this is the part before the @ symbol. You can use up to 127 printable characters and spaces.
Authentication	

Table 99 Voice &gt; SIP &gt; SIP Account &gt; SIP Account Entry Edit (continued)

LABEL	DESCRIPTION
Username	Enter the user name for registering this SIP account, exactly as it was given to you. You can use up to 95 alphanumeric (0-9, a-z, A-Z), printable special characters and spaces.
Password	Enter the password for registering this SIP account, exactly as it was given to you. You can use up to 95 alphanumeric (0-9, a-z, A-Z), printable special characters and spaces.
URL Type	
URL Type	<p>Select whether or not to include the SIP service domain name when the Zyxel Device sends the SIP number.</p> <p><b>SIP</b> – include the SIP service domain name.</p> <p><b>TEL</b> – do not include the SIP service domain name.</p>
Voice Features	
Primary/Secondary/Third Compression Type	<p>Select the type of voice coder or decoder (codec) that you want the Zyxel Device to use.</p> <p>G.711 provides higher voice quality but requires more bandwidth (64 kbps).</p> <ul style="list-style-type: none"> <li>• <b>G.729</b> provides good sound quality and reduces the required bandwidth to 8 kbps.</li> <li>• <b>G.711a</b> is typically used in Europe.</li> <li>• <b>G.711u</b> is typically used in North America and Japan.</li> <li>• <b>G.726-32</b> operates at 16, 24, 32 or 40 kbps.</li> <li>• <b>G.722</b> operates at 6.3 kbps or 5.3 kbps.</li> </ul> <p>When two SIP devices start a SIP session, they must agree on a codec.</p> <p>Select the Zyxel Device's first choice for voice coder or decoder.</p> <p>Select the Zyxel Device's second choice for voice coder or decoder. Select <b>None</b> if you only want the Zyxel Device to accept the first choice.</p> <p>Select the Zyxel Device's third choice for voice coder or decoder. Select <b>None</b> if you only want the Zyxel Device to accept the first or second choice.</p>
Speaking Volume Control	Select the loudness that the Zyxel Device uses for speech that it sends to the peer device. Choices are <b>Minimum</b> , <b>Middle</b> , and <b>Maximum</b> .
Listening Volume Control	Select the loudness that the Zyxel Device uses for speech that it receives from the peer device. Choices are <b>Minimum</b> , <b>Middle</b> , and <b>Maximum</b> .
Enable G. 168 (Echo Cancellation)	Select this if you want to eliminate the echo caused by the sound of your voice reverberating in the telephone receiver while you talk.
Enable VAD (Voice Active Detector)	Select this if the Zyxel Device should stop transmitting when you are not speaking. This reduces the bandwidth the Zyxel Device uses.
Call Features	
Send Caller ID	Select this if you want to send identification when you make VoIP phone calls. Clear this if you do not want to send identification.
OK	Click this to save your changes.
Cancel	Click this to exit this screen without saving.

## 19.5 SIP Service Provider

Use this screen to view the SIP service provider information on the Zyxel Device. A SIP provider offers Internet call services using VoIP technology. You may need to consult your SIP service provider for the following settings.

To access this screen, click **Voice > SIP > SIP Service Provider**.

**Figure 174** Voice > SIP > SIP Service Provider

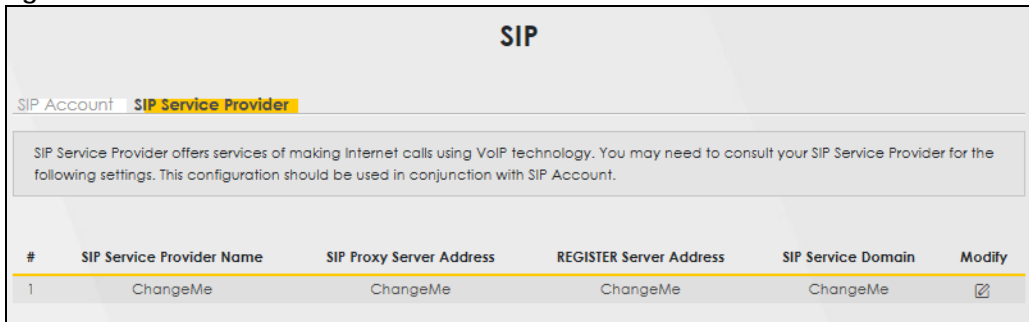

The following table describes the labels in this screen.

Table 100 Voice > SIP > SIP Service Provider

LABEL	DESCRIPTION
#	This is the index number of the entry.
SIP Service Provider Name	This shows the name of the SIP service provider.
SIP Proxy Server Address	This shows the IP address or domain name of the SIP server.
REGISTER Server Address	This shows the IP address or domain name of the SIP register server.
SIP Service Domain	Enter the SIP service domain name. In the full SIP URI, this is the part after the @symbol. You can use up to 127 printable ASCII Extended set characters.
Modify	Click the <b>Modify</b> icon to configure the profile of SIP service provider settings.

### 19.5.1 Provider Entry Edit

Use this screen to configure the SIP server information, the numbers for certain phone functions and dialing plan for a SIP service provider.

Click the **Modify** icon next to a profile of SIP service provider settings in the **Voice > SIP > SIP Service Provider** to open the following screen.

Figure 175 Voice &gt; SIP &gt; SIP Service Provider: Edit

**Provider Entry Edit**

**SIP Service Provider Selection**  
Service Provider Selection: ChangeMe

**General**

SIP Service Provider:  Enable SIP Service Provider

SIP Service Provider Name: ChangeMe

SIP Local Port: 5040 (1025-65535)

SIP Proxy Server Address: ChangeMe

SIP Proxy Server Port: 5040 (1025-65535)

SIP REGISTRAR Server Address: ChangeMe

SIP REGISTRAR Server Port: 5040 (1025-65535)

SIP Service Domain: ChangeMe

**RFC Support**

PRACK (RFC 3262, Require: 100rel)

**VoIP IOP Flags**

Replace dial digit '#' to '%23' in SIP messages

Remove the 'Route' header in SIP messages

**Bound Interface Name**

Bound Interface Name:  AnyWAN  MultWAN

**Outbound Proxy**

Outbound Proxy Address:

Outbound Proxy Port: 5040 (1025-65535)

Use DHCP Option 120 First

**RTP Port Range**

Start Port: 40000 (1024-65535)

End Port: 40010 (1044-65500)

**DTMF Mode**

DTMF Mode: RFC 2833

**Transport Type**

Transport Type: UDP

**Ignore Direct IP**

Enable  Disable

**FAX Option**

G.711 Fax Passthrough  T.38 Fax Relay

**GoS Tag**

SIP DSCP Mark Setting: 46 (0-43)

RTP DSCP Mark Setting: 46 (0-43)

**Timer Setting**

SIP Register Expiration Duration: 3600 (60-65535) seconds

SIP Register Fail Re-try Timer: 1800 (180-65535) seconds

Session Expires (SE): 900 (100-3600) seconds

Min-SE: 600 (90-1800) seconds

**Dialing Interval Selection**

Dialing Interval Selection: 3 seconds

**DNS SRV**

Enable DNS SRV

Cancel OK

The following table describes the labels in this screen.

Table 101 Voice &gt; SIP &gt; SIP Service Provider &gt; Add New Provider or Edit

LABEL	DESCRIPTION
General	
SIP Service Provider	Select this if you want the Zyxel Device to use this SIP provider. Clear it if you do not want the Zyxel Device to use this SIP provider.
SIP Service Provider Name	Enter the name of your SIP service provider.
SIP Local Port	Enter the Zyxel Device's listening port number, if your VoIP service provider gave you one. Otherwise, keep the default value.

Table 101 Voice &gt; SIP &gt; SIP Service Provider &gt; Add New Provider or Edit (continued)

LABEL	DESCRIPTION
SIP Proxy Server Address	Enter the IP address or domain name of the SIP server provided by your VoIP service provider. You can use up to 95 printable characters except [ " ], [ ` ], [ ' ], [ < ], [ > ], [ ^ ], [ \$ ], [   ], [ & ], or [ ; ]. It does not matter whether the SIP server is a proxy, redirect or register server.
SIP Proxy Server Port	Enter the SIP server's listening port number, if your VoIP service provider gave you one. Otherwise, keep the default value.
SIP REGISTRAR Server Address	Enter the IP address or domain name of the SIP register server, if your VoIP service provider gave you one. Otherwise, enter the same address you entered in the <b>SIP Server Address</b> field. You can use up to 95 printable characters except [ " ], [ ` ], [ ' ], [ < ], [ > ], [ ^ ], [ \$ ], [   ], [ & ], or [ ; ].
SIP REGISTRAR Server Port	Enter the SIP register server's listening port number, if your VoIP service provider gave you one. Otherwise, enter the same port number you entered in the <b>SIP Server Port</b> field.
SIP Service Domain	Enter the SIP service domain name. In the full SIP URI, this is the part after the @ symbol. You can use up to 127 printable characters except [ " ], [ ` ], [ ' ], [ < ], [ > ], [ ^ ], [ \$ ], [   ], [ & ], or [ ; ].
RFC Support	
PRACK (RFC 3262)	<p>RFC 3262 defines a mechanism to provide reliable transmission of SIP provisional response messages, which convey information on the processing progress of the request. This uses the option tag 100rel and the Provisional Response ACKnowledgement (PRACK) method.</p> <p>Select <b>Supported</b> or <b>Required</b> to have the Zyxel Device include a SIP Require or Supported header field with the option tag 100rel in all INVITE requests. When the Zyxel Device receives a SIP response message indicating that the phone it called is ringing, the Zyxel Device sends a PRACK message to have both sides confirm the message is received.</p> <p>If you select <b>Supported</b>, the peer device supports the option tag 100rel to send provisional responses reliably.</p> <p>If you select <b>Required</b>, the peer device requires the option tag 100rel to send provisional responses reliably.</p> <p>Select <b>Disabled</b> to turn off this function.</p>
VoIP IOP Flags – Select VoIP inter-operability settings.	
Replace dial digit '#' to '%23' in SIP messages	Replace a dial digit "#" with "%23" in the INVITE messages.
Remove the 'Route' header in SIP messages	Remove the 'Route' header in SIP packets.
Bound Interface Name	
Bound Interface Name	<p>If you select <b>AnyWAN</b>, the Zyxel Device automatically activates the VoIP service when any WAN connection is up.</p> <p>If you select <b>MultiWAN</b>, you also need to select the pre-configured WAN connections. The VoIP service is activated only when one of the selected WAN connections is up.</p>
Outbound Proxy	
Outbound Proxy Address	Enter the IP address or domain name of the SIP outbound proxy server if your VoIP service provider has a SIP outbound server to handle voice calls. This allows the Zyxel Device to work with any type of NAT router and eliminates the need for STUN or a SIP ALG. Turn off any SIP ALG on a NAT router in front of the Zyxel Device to keep it from re-translating the IP address (since this is already handled by the outbound proxy server).
Outbound Proxy Port	Enter the SIP outbound proxy server's listening port, if your VoIP service provider gave you one. Otherwise, keep the default value.



Table 101 Voice &gt; SIP &gt; SIP Service Provider &gt; Add New Provider or Edit (continued)

LABEL	DESCRIPTION
Use DHCP Option 120 first	Select this to have the Zyxel Device use DHCP Option 120 first.
RTP Port Range	
Start/End Port	<p>Enter the listening port numbers for RTP traffic, if your VoIP service provider gave you this information. Otherwise, keep the default values.</p> <p>To enter one port number, enter the port number in the <b>Start Port</b> and <b>End Port</b> fields.</p> <p>To enter a range of ports,</p> <ul style="list-style-type: none"> <li>• enter the port number at the beginning of the range in the <b>Start Port</b> field.</li> <li>• enter the port number at the end of the range in the <b>End Port</b> field.</li> </ul>
DTMF Mode	<p>Control how the Zyxel Device handles the tones that your telephone makes when you push its buttons. You should use the same mode your VoIP service provider uses.</p> <p><b>RFC2833</b> – send the DTMF tones in RTP packets.</p> <p><b>Inband</b> – send the DTMF tones in the voice data stream. This method works best when you are using a codec that does not use compression (like G.711). Codecs that use compression (like G.726) can distort the tones.</p> <p><b>SIP Info</b> – send the DTMF tones in SIP messages.</p>
Transport Type	
Transport Type	<p>Select the protocol used to transport the SIP packets.</p> <p>For <b>UDP</b> and <b>TCP</b>, see the Service appendix for more information on the example services and the required protocol and port number.</p>
Ignore Direct IP	Select <b>Enable</b> to have the connected devices accept SIP requests only from the SIP proxy/register server specified above. SIP requests sent from other IP addresses will be ignored.
FAX Option	This field controls how the Zyxel Device handles fax messages.
QoS Tag	
SIP DSCP Mark Setting	Enter the DSCP (DiffServ Code Point) number for SIP message transmissions. The Zyxel Device creates Class of Service (CoS) priority tags with this number to SIP traffic that it transmits.
RTP DSCP Mark Setting	Enter the DSCP (DiffServ Code Point) number for RTP voice transmissions. The Zyxel Device creates Class of Service (CoS) priority tags with this number to RTP traffic that it transmits.
Timer Setting	
SIP Register Expiration Duration	Enter the number of seconds your SIP account is registered with the SIP register server before it is deleted. The Zyxel Device automatically tries to re-register your SIP account when one-half of this time has passed (The SIP register server might have a different expiration).
SIP Register Fall Re-try timer	Enter the number of seconds the Zyxel Device waits before it tries again to register the SIP account, if the first try failed or if there is no response.
Session Expires [SE]	Enter the number of seconds the Zyxel Device lets a SIP session remain idle (without traffic) before it automatically disconnects the session.
Min-SE	Enter the minimum number of seconds the Zyxel Device lets a SIP session remain idle (without traffic) before it automatically disconnects the session. When two SIP devices start a SIP session, they must agree on an expiration time for idle sessions. This field is the shortest expiration time that the Zyxel Device accepts.
Dialing Interval Selection	
Dialing Interval Selection	Enter the number of seconds the Zyxel Device should wait after you stop dialing numbers before it makes the phone call. The value depends on how quickly you dial phone numbers.

Table 101 Voice &gt; SIP &gt; SIP Service Provider &gt; Add New Provider or Edit (continued)

LABEL	DESCRIPTION
Enable DNS SRV	Select this to have the Zyxel Device query your ISP's DNS server for a list of any available SIP servers that it maintains. This is useful if your static SIP server experiences difficulties, making it hard for your IP phone users to make SIP calls.
OK	Click this to save your changes.
Cancel	Click this to exit this screen without saving.

## 19.6 Phone

Use these screens to configure SIP numbers and regions for IP phones that are connected to the Zyxel Device.

### 19.6.1 Phone Device

Use this screen to view detailed information on phones used for Internet phone calls (SIP). You can define which phones will ring when a specific SIP address receives an incoming call, and which SIP address will be used when an outgoing call is made with a specific phone.

To access this screen, click **Voice > Phone > Phone Device**.

Figure 176 Voice &gt; Phone &gt; Phone Device

Phone Device configuration defines the relations between your SIP account(s) and phone(s). That is, which phone(s) will ring when a specific SIP account number receive an incoming call; and which SIP account number will be used when a specific phone is used to make an outgoing call.				
<b>Analog Phone</b>				
#	Phone ID	Incoming SIP Number	Outgoing SIP Number	Modify
1	PHONE1	ChangeMe	ChangeMe	

Each field is described in the following table.

Table 102 Voice &gt; Phone &gt; Phone Device

LABEL	DESCRIPTION
#	This displays the index number of the phone device.
Phone ID	This field displays the name of a phone port on the Zyxel Device.
Incoming SIP Number	This field displays the SIP address that you use to receive calls on this phone port.
Outgoing SIP Number	This field displays the SIP address that you use to make calls on this phone port.
Modify	Click the <b>Edit</b> icon to configure the SIP account.

### 19.6.2 Phone Device Edit

Use this screen to control which SIP account and PSTN line each phone uses. Click an **Edit** icon in **Voice > Phone > Phone Device** to open the following screen.

Figure 177 Voice &gt; Phone &gt; Phone Device &gt; Edit

**Phone Device Edit**

**SIP Account to Make Outgoing Call**

SIP Account	SIP Number
<input checked="" type="radio"/> SIP1	ChangeMe
<input type="radio"/> SIP2	ChangeMe

**SIP Account(s) to Receive Incoming Call**

SIP Account	directoryNumber
<input checked="" type="checkbox"/> SIP1	ChangeMe
<input type="checkbox"/> SIP2	ChangeMe

**Immediate Dial Enable**

Immediate Dial Enable

Cancel OK

Each field is described in the following table.

Table 103 Voice &gt; Phone &gt; Phone Device &gt; Edit

LABEL	DESCRIPTION
SIP Account to Make Outgoing Call	Select the SIP account you want to use when making outgoing calls with the analog phone connected to this phone port.
SIP Account(s) to Receive Incoming Call	Select a SIP account if you want to receive phone calls for the selected SIP account on this phone port.  If you select more than one SIP account for incoming calls, there is no way to distinguish between them when you receive phone calls. If you do not select a source for incoming calls, you cannot receive any calls on this phone port.
Immediate Dial Enable	Select this if you want to use the pound key (#) to tell the Zyxel Device to make the phone call immediately, instead of waiting for the number of second you selected in the <b>Dialog Interval Selection</b> field of the <b>VoIP &gt; SIP &gt; SIP Service Provider &gt; Add New Provider</b> or <b>Edit</b> screen.  If you select this, dial the phone number, and then press the pound key. The Zyxel Device makes the call immediately instead of waiting. You can still wait, if you want.
Cancel	Click <b>Cancel</b> to exit this screen without saving
OK	Click <b>OK</b> to save your changes.

## 19.7 Phone Region

Use this screen to configure settings that depend on which region of the world the Zyxel Device is in. Selecting the region where the device is physically located improves the quality of phone calls.

To access this screen, click **Voice > Phone**.

**Figure 178** Voice > Phone

The following table describes the labels in this screen.

Table 104 Voice > Phone

LABEL	DESCRIPTION
Region Setting	Select the place in which the Zyxel Device is located.
Call Service Mode	Select the mode for supplementary phone services (call hold, call waiting, call transfer and three-way conference calls) that your VoIP service provider supports. <ul style="list-style-type: none"> <li>• <b>Europe Type</b> – use supplementary phone services in European mode.</li> <li>• <b>USA Type</b> – use supplementary phone services American mode.</li> </ul> You might have to subscribe to these services to use them. Contact your VoIP service provider.
Apply	Click this to save your changes and to apply them to the Zyxel Device.
Cancel	Click this to set every field in this screen to its last-saved value.

Note: You need to reboot the Zyxel Device after changing the region settings for it to take effect.

## 19.8 Call Rule

Use this screen to add, edit, or remove speed-dial numbers for outgoing calls. Speed dial provides shortcuts for dialing frequently-used (VoIP) phone numbers. You also have to create speed-dial entries if you want to call SIP numbers that contain letters. Once you have configured a speed dial rule, you can use a shortcut (the speed dial number, #01 for example) on your phone's keypad to call the phone number. To access this screen, click **Voice > Call Rule**.

Figure 179 Voice &gt; Call Rule

**Call Rule**

When certain phone numbers are dialed on a regular basis, Speed Dial accelerates dialing process. The following rules apply to all the phone devices connected to this device.

[Clear All Speed Dials](#)

Keys	Number	Description
#01		
#02		
#03		
#04		
#05		
#06		
#07		
#08		
#09		
#10		

[Cancel](#)      [Apply](#)

The following table describes the labels in this screen.

Table 105 Voice &gt; Call Rule

LABEL	DESCRIPTION
Keys	This field displays the speed-dial number you should dial to use this entry.
Number	Enter the SIP number you want the Zyxel Device to call when you dial the speed-dial number.
Description	Enter a short description to identify the party you call when you dial the speed-dial number. You can use up to 127 printable characters except [ " ], [ ` ], [ ' ], [ < ], [ > ], [ ^ ], [ \$ ], [   ], [ & ], or [ ; ]. Spaces are allowed.
Clear All Speed Dials	Click this button to remove all speed dials saved.
Apply	Click this to save your changes and to apply them to the Zyxel Device.
Cancel	Click this to set every field in this screen to its last-saved value.

## 19.9 Call History

The Zyxel Device logs calls from or to your SIP addresses. This screen allows you to view a summary of received, dialed and missed calls and a call history list. You can also view detailed information on each outgoing and incoming call.

### 19.9.1 Call History Screen

To access this screen, click **Voice > Call History**.

Figure 180 Voice &gt; Call History

Each field is described in the following table.

Table 106 Voice &gt; Call History

LABEL	DESCRIPTION
Clear	Click this button to remove all entries from the call history list.
Refresh	Click this button to renew the call history list.
Export	Click this button to download a call history list.
Incoming Calls	This displays how many calls you received that day.
Outgoing Calls	This displays how many calls originated from you that day.
Missing Calls	This displays how many incoming calls were not answered that day.
Classify	Select the type of the calls. The call types are: <b>All</b> , <b>Incoming</b> , <b>Outgoing</b> and <b>Missed</b> .
Type	This displays the type of the calls.
Date	This displays the date and time when the calls were made.
Name	This displays the SIP account you called.
Peer Number	This displays the SIP address that called you or you called.
Phone Device	This displays the name of a phone port on the Zyxel Device.
Outgoing Number	This displays the SIP address you used to make outgoing calls or receive calls.
Duration (hh:mm:ss)	This displays how long the call lasted.
Modify	Click the <b>Delete</b> icon to remove the call history.

## 19.10 Technical Reference

This section contains background material relevant to the **VoIP** screens.

## VoIP

VoIP is the sending of voice signals over Internet Protocol. This allows you to make phone calls and send faxes over the Internet at a fraction of the cost of using the traditional circuit-switched telephone network. You can also use servers to run telephone service applications like PBX services and voice mail. Internet Telephony Service Provider (ITSP) companies provide VoIP service.

Circuit-switched telephone networks require 64 kilobits per second (Kbps) in each direction to handle a telephone call. VoIP can use advanced voice coding techniques with compression to reduce the required bandwidth.

## SIP

The Session Initiation Protocol (SIP) is an application-layer control (signaling) protocol that handles the setting up, altering and tearing down of voice and multimedia sessions over the Internet.

SIP signaling is separate from the media for which it handles sessions. The media that is exchanged during the session can use a different path from that of the signaling. SIP handles telephone calls and can interface with traditional circuit-switched telephone networks.

## SIP Identities

A SIP account uses an identity (sometimes referred to as a SIP address). A complete SIP identity is called a SIP URI (Uniform Resource Identifier). A SIP account's URI identifies the SIP account in a way similar to the way an email address identifies an email account. The format of a SIP identity is SIP-Number@SIP-Service-Domain.

## SIP Number

The SIP number is the part of the SIP URI that comes before the "@" symbol. A SIP number can use letters like in an email address (johndoe@your-ITSP.com for example) or numbers like a telephone number (1122334455@VoIP-provider.com for example).

## SIP Service Domain

The SIP service domain of the VoIP service provider is the domain name in a SIP URI. For example, if the SIP address is [1122334455@VoIP-provider.com](mailto:1122334455@VoIP-provider.com), then "VoIP-provider.com" is the SIP service domain.

## SIP Registration

Each Zyxel Device is an individual SIP User Agent (UA). To provide voice service, it has a public IP address for SIP and RTP protocols to communicate with other servers.

A SIP user agent has to register with the SIP registrar and must provide information about the users it represents, as well as its current IP address (for the routing of incoming SIP requests). After successful registration, the SIP server knows that the users (identified by their dedicated SIP URIs) are represented by the UA, and knows the IP address to which the SIP requests and responses should be sent.

Registration is initiated by the User Agent Client (UAC) running in the VoIP gateway (the Zyxel Device). The gateway must be configured with information letting it know where to send the REGISTER message, as well as the relevant user and authorization data.

A SIP registration has a limited lifespan. The User Agent Client must renew its registration within this lifespan. If it does not do so, the registration data will be deleted from the SIP registrar's database and the connection broken.

The Zyxel Device attempts to register all enabled subscriber ports when it is switched on. When you enable a subscriber port that was previously disabled, the Zyxel Device attempts to register the port immediately.

## Authorization Requirements

SIP registrations (and subsequent SIP requests) require a username and password for authorization. These credentials are validated through a challenge / response system using the HTTP digest mechanism (as detailed in RFC 3261, "SIP: Session Initiation Protocol").

## SIP Servers

SIP is a client-server protocol. A SIP client is an application program or device that sends SIP requests. A SIP server responds to the SIP requests.

When you use SIP to make a VoIP call, it originates at a client and terminates at a server. A SIP client could be a computer or a SIP phone. One device can act as both a SIP client and a SIP server.

## SIP User Agent

A SIP user agent can make and receive VoIP telephone calls. This means that SIP can be used for peer-to-peer communications even though it is a client-server protocol. In the following figure, either **A** or **B** can act as a SIP user agent client to initiate a call. **A** and **B** can also both act as a SIP SIP user agent to receive the call.

Figure 181 SIP User Agent

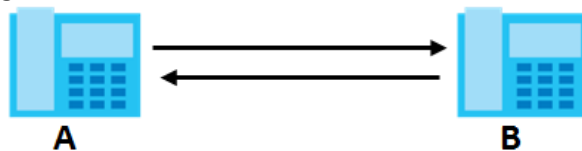

## SIP Proxy Server

A SIP proxy server receives requests from clients and forwards them to another server.

In the following example, you want to use client device **A** to call someone who is using client device **C**.

- 1 The client device (**A** in the figure) sends a call invitation to the SIP proxy server (**B**).
- 2 The SIP proxy server forwards the call invitation to **C**.



Figure 182 SIP Proxy Server

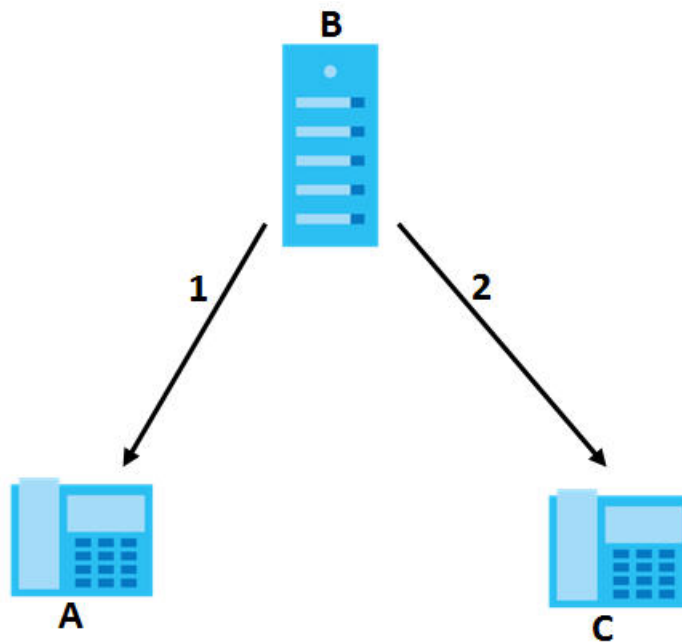

### SIP Redirect Server

A SIP redirect server accepts SIP requests, translates the destination address to an IP address and sends the translated IP address back to the device that sent the request. Then the client device that originally sent the request can send requests to the IP address that it received back from the redirect server. Redirect servers do not initiate SIP requests.

In the following example, you want to use client device **A** to call someone who is using client device **C**.

- 1 Client device **A** sends a call invitation for **C** to the SIP redirect server (**B**).
- 2 The SIP redirect server sends the invitation back to **A** with **C**'s IP address (or domain name).
- 3 Client device **A** then sends the call invitation to client device **C**.

Figure 183 SIP Redirect Server

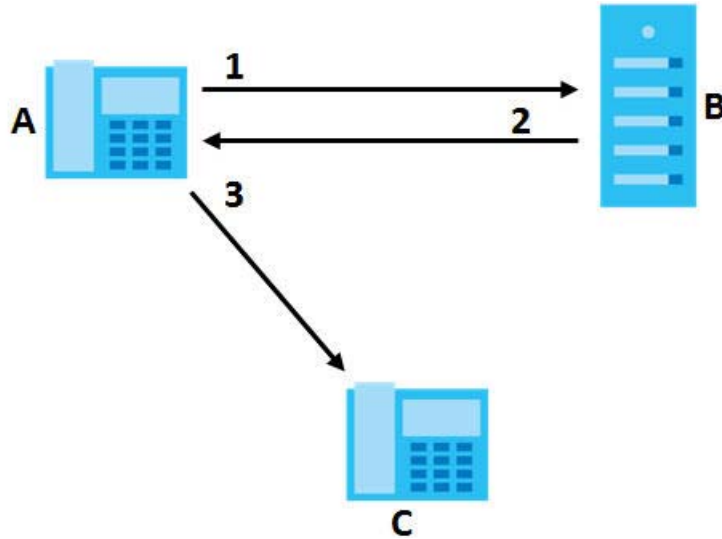

### SIP Register Server

A SIP register server maintains a database of SIP identity-to-IP address (or domain name) mapping. The register server checks your user name and password when you register.

### RTP

When you make a VoIP call using SIP, the RTP (Real time Transport Protocol) is used to handle voice data transfer. See RFC 1889 for details on RTP.

### Pulse Code Modulation

Pulse Code Modulation (PCM) measures analog signal amplitudes at regular time intervals and converts them into bits.

### SIP Call Progression

The following figure displays the basic steps in the setup and tear down of a SIP call. A calls B.

Table 107 SIP Call Progression

A		B
1. INVITE	→	
	←	2. Ringing
	←	3. OK
4. ACK	→	
		5. Dialogue (voice traffic)
6. BYE	→	
	←	7. OK

- 1 **A** sends a SIP INVITE request to **B**. This message is an invitation for **B** to participate in a SIP telephone call.
- 2 **B** sends a response indicating that the telephone is ringing.
- 3 **B** sends an OK response after the call is answered.
- 4 **A** then sends an ACK message to acknowledge that **B** has answered the call.
- 5 Now **A** and **B** exchange voice media (talk).
- 6 After talking, **A** hangs up and sends a BYE request.
- 7 **B** replies with an OK response confirming receipt of the BYE request and the call is terminated.

### SIP Call Progression Through Proxy Servers

Usually, the SIP UAC sets up a phone call by sending a request to the SIP proxy server. Then, the proxy server looks up the destination to which the call should be forwarded (according to the URI requested by the SIP UAC). The request may be forwarded to more than one proxy server before arriving at its destination.

The response to the request goes to all the proxy servers through which the request passed, in reverse sequence. Once the session is set up, session traffic is sent between the UAs directly, bypassing all the proxy servers in between.

The following figure shows the SIP and session traffic flow between the user agents (**UA 1** and **UA 2**) and the proxy servers (this example shows two proxy servers, **PROXY 1** and **PROXY 2**).

**Figure 184** SIP Call Through Proxy Servers

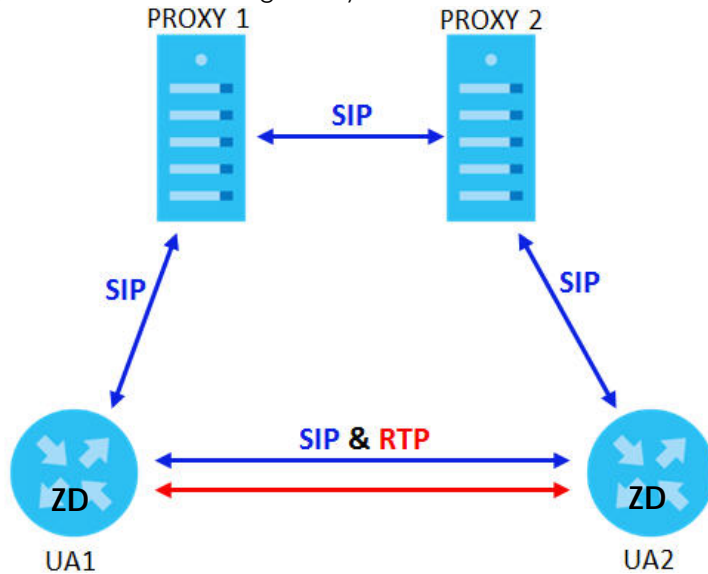

The following table shows the SIP call progression.

Table 108 SIP Call Progression

UA 1		PROXY 1		PROXY 2		UA 2
Invite	→		Invite	→		

Table 108 SIP Call Progression (continued)

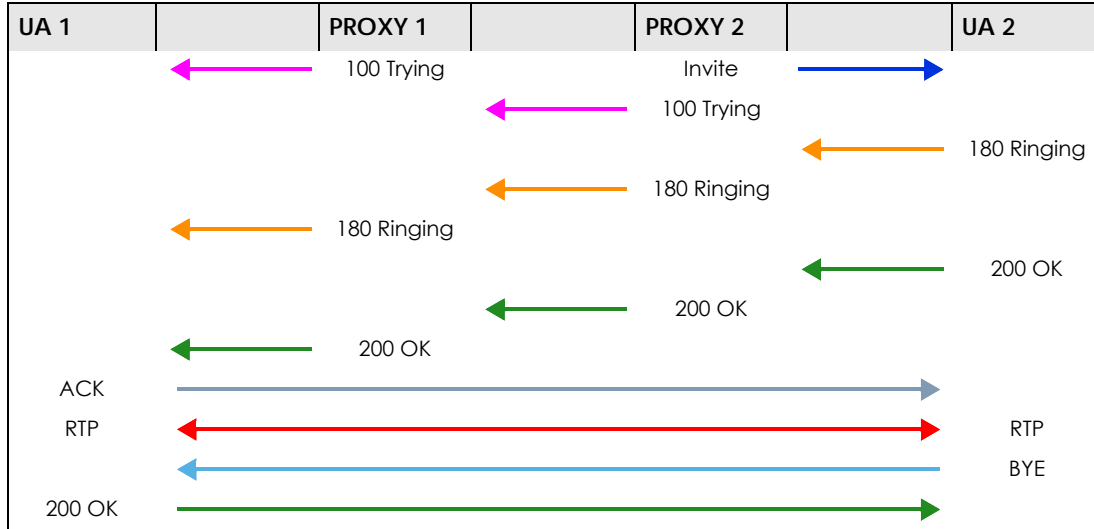

- User Agent 1** sends a SIP INVITE request to **Proxy 1**. This message is an invitation to **User Agent 2** to participate in a SIP telephone call. **Proxy 1** sends a response indicating that it is trying to complete the request.
- Proxy 1** sends a SIP INVITE request to **Proxy 2**. **Proxy 2** sends a response indicating that it is trying to complete the request.
- Proxy 2** sends a SIP INVITE request to **User Agent 2**.
- User Agent 2** sends a response back to **Proxy 2** indicating that the phone is ringing. The response is relayed back to **User Agent 1** through **Proxy 1**.
- User Agent 2** sends an OK response to **Proxy 2** after the call is answered. This is also relayed back to **User Agent 1** through **Proxy 1**.
- User Agent 1** and **User Agent 2** exchange RTP packets containing voice data directly, without involving the proxies.
- When **User Agent 2** hangs up, he sends a BYE request.
- User Agent 1** replies with an OK response confirming receipt of the BYE request, and the call is terminated.

## Voice Coding

A codec (coder/decoder) codes analog voice signals into digital signals and decodes the digital signals back into analog voice signals. The Zyxel Device supports the following codecs.

- G.711 is a Pulse Code Modulation (PCM) waveform codec. PCM measures analog signal amplitudes at regular time intervals and converts them into digital samples. G.711 provides very good sound quality but requires 64 kbps of bandwidth.

- G.726 is an Adaptive Differential PCM (ADPCM) waveform codec that uses a lower bitrate than standard PCM conversion. ADPCM converts analog audio into digital signals based on the difference between each audio sample and a prediction based on previous samples. The more similar the audio sample is to the prediction, the less space needed to describe it. G.726 operates at 16, 24, 32 or 40 kbps.
- G.729 is an Analysis-by-Synthesis (AbS) hybrid waveform codec that uses a filter based on information about how the human vocal tract produces sounds. G.729 provides good sound quality and reduces the required bandwidth to 8 kbps.

## Voice Activity Detection/Silence Suppression

Voice Activity Detection (VAD) detects whether or not speech is present. This lets the Zyxel Device reduce the bandwidth that a call uses by not transmitting "silent packets" when you are not speaking.

## Comfort Noise Generation

When using VAD, the Zyxel Device generates comfort noise when the other party is not speaking. The comfort noise lets you know that the line is still connected as total silence could easily be mistaken for a lost connection.

## Echo Cancellation

G.168 is an ITU-T standard for eliminating the echo caused by the sound of your voice reverberating in the telephone receiver while you talk.

## MWI (Message Waiting Indication)

Enable Message Waiting Indication (MWI) enables your phone to give you a message-waiting (beeping) dial tone when you have a voice message(s). Your VoIP service provider must have a messaging system that sends message waiting status SIP packets as defined in RFC 3842.

## Custom Tones (IVR)

IVR (Interactive Voice Response) is a feature that allows you to use your telephone to interact with the Zyxel Device. The Zyxel Device allows you to record custom tones for the **Early Media** and **Music On Hold** functions. The same recordings apply to both the caller ringing and on hold tones.

Table 109 Custom Tones Details

LABEL	DESCRIPTION
Total Time for All Tones	900 seconds for all custom tones combined
Maximum Time per Individual Tone	180 seconds
Total Number of Tones Recordable	5 You can record up to 5 different custom tones but the total time must be 900 seconds or less.

## Recording Custom Tones

Use the following steps if you would like to create new tones or change your tones:

- 1 Pick up the phone and press “\*\*\*\*” on your phone's keypad and wait for the message that says you are in the configuration menu.
- 2 Press a number from 1101 – 1105 on your phone followed by the “#” key.
- 3 Play your desired music or voice recording into the receiver's mouthpiece. Press the “#” key.
- 4 You can continue to add, listen to, or delete tones, or you can hang up the receiver when you are done.

### Listening to Custom Tones

Do the following to listen to a custom tone:

- 1 Pick up the phone and press “\*\*\*\*” on your phone's keypad and wait for the message that says you are in the configuration menu.
- 2 Press a number from 1201 – 1208 followed by the “#” key to listen to the tone.
- 3 You can continue to add, listen to, or delete tones, or you can hang up the receiver when you are done.

### Deleting Custom Tones

Do the following to delete a custom tone:

- 1 Pick up the phone and press “\*\*\*\*” on your phone's keypad and wait for the message that says you are in the configuration menu.
- 2 Press a number from 1301 – 1308 followed by the “#” key to delete the tone of your choice. Press 14 followed by the “#” key if you wish to clear all your custom tones.

You can continue to add, listen to, or delete tones, or you can hang up the receiver when you are done.

## 19.10.1 Quality of Service (QoS)

Quality of Service (QoS) refers to both a network's ability to deliver data with minimum delay, and the networking methods used to provide bandwidth for real-time multimedia applications.

### Type of Service (ToS)

Network traffic can be classified by setting the ToS (Type of Service) values at the data source (for example, at the Zyxel Device) so a server can decide the best method of delivery, that is the least cost, fastest route and so on.

### DiffServ

DiffServ is a class of service (CoS) model that marks packets so that they receive specific per-hop treatment at DiffServ-compliant network devices along the route based on the application types and traffic flow. Packets are marked with DiffServ Code Points (DSCP) indicating the level of service desired.

This allows the intermediary DiffServ-compliant network devices to handle the packets differently depending on the code points without the need to negotiate paths or remember state information for every flow. In addition, applications do not have to request a particular service or give advanced notice of where the traffic is going.<sup>3</sup>

## DSCP and Per-Hop Behavior

DiffServ defines a new DS (Differentiated Services) field to replace the Type of Service (TOS) field in the IP header. The DS field contains a 2-bit unused field and a 6-bit DSCP field which can define up to 64 service levels. The following figure illustrates the DS field.

DSCP is backward compatible with the three precedence bits in the ToS octet so that non-DiffServ compliant, ToS-enabled network device will not conflict with the DSCP mapping.

**Figure 185** DiffServ: Differentiated Service Field

DSCP (6-bit)	Unused (2-bit)
-----------------	-------------------

The DSCP value determines the forwarding behavior, the PHB (Per-Hop Behavior), that each packet gets across the DiffServ network. Based on the marking rule, different kinds of traffic can be marked for different priorities of forwarding. Resources can then be allocated according to the DSCP values and the configured policies.

## 19.10.2 Phone Services Overview

Supplementary services such as call hold, call waiting, and call transfer, are generally available from your VoIP service provider. The Zyxel Device supports the following services:

- Call Return
- Call Hold
- Call Waiting
- Making a Second Call
- Call Transfer
- Call Forwarding
- Three-Way Conference
- Internal Calls
- Call Park and Pickup
- Do not Disturb
- IVR
- Call Completion
- CCBS
- Outgoing SIP

---

3. The Zyxel Device does not support DiffServ at the time of writing.

Note: To take full advantage of the supplementary phone services available through the Zyxel Device's phone ports, you may need to subscribe to the services from your VoIP service provider.

### 19.10.2.1 The Flash Key

Flashing means to press the hook for a short period of time (a few hundred milliseconds) before releasing it. On newer telephones, there should be a "flash" key (button) that generates the signal electronically. If the flash key is not available, you can tap (press and immediately release) the hook by hand to achieve the same effect. However, using the flash key is preferred since the timing is much more precise. With manual tapping, if the duration is too long, it may be interpreted as hanging up by the Zyxel Device.

You can invoke all the supplementary services by using the flash key.

### 19.10.2.2 Europe Type Supplementary Phone Services

This section describes how to use supplementary phone services with the **Europe Type Call Service Mode**. Commands for supplementary services are listed in the table below.

After pressing the flash key, if you do not issue the sub-command before the default sub-command timeout (2 seconds) expires or issue an invalid sub-command, the current operation will be aborted.

Table 110 European Flash Key Commands

COMMAND	SUB-COMMAND	DESCRIPTION
Flash		Put a current call on hold to place a second call. Switch back to the call (if there is no second call).
Flash	0	Drop the call presently on hold or reject an incoming call which is waiting for answer.
Flash	1	Disconnect the current phone connection and answer the incoming call or resume with caller presently on hold.
Flash	2	1. Switch back and forth between two calls. 2. Put a current call on hold to answer an incoming call. 3. Separate the current three-way conference call into two individual calls (one is on-line, the other is on hold).
Flash	3	Create three-way conference connection.
Flash	*98#	Transfer the call to another phone.

### European Call Hold

Call hold allows you to put a call (**A**) on hold by pressing the flash key.

If you have another call, press the flash key and then "2" to switch back and forth between caller **A** and **B** by putting either one on hold.

Press the flash key and then "0" to disconnect the call presently on hold and keep the current call on line.

Press the flash key and then "1" to disconnect the current call and resume the call on hold.

If you hang up the phone but a caller is still on hold, there will be a remind ring.



## European Call Waiting

This allows you to place a call on hold while you answer another incoming call on the same telephone (directory) number.

If there is a second call to a telephone number, you will hear a call waiting tone. Take one of the following actions.

- Reject the second call.  
Press the flash key and then press "0".
- Disconnect the first call and answer the second call.  
Either press the flash key and press "1", or just hang up the phone and then answer the phone after it rings.
- Put the first call on hold and answer the second call.  
Press the flash key and then "2".

## European Call Transfer

Do the following to transfer an incoming call (that you have answered) to another phone.

- 1 Press the flash key to put the caller on hold.
- 2 When you hear the dial tone, dial "\*\*98#" followed by the number to which you want to transfer the call.
- 3 After you hear the ring signal or the second party answers it, hang up the phone.

## European Three-Way Conference

Use the following steps to make three-way conference calls.

- 1 When you are on the phone talking to someone, press the flash key to put the caller on hold and get a dial tone.
- 2 Dial a phone number directly to make another call.
- 3 When the second call is answered, press the flash key and press "3" to create a three-way conversation.
- 4 Hang up the phone to drop the connection.
- 5 If you want to separate the activated three-way conference into two individual connections (one is on-line, the other is on hold), press the flash key and press "2".

### 19.10.2.3 USA Type Supplementary Services

This section describes how to use supplementary phone services with the **USA Type Call Service Mode**. Commands for supplementary services are listed in the table below.

After pressing the flash key, if you do not issue the sub-command before the default sub-command timeout (2 seconds) expires or issue an invalid sub-command, the current operation will be aborted.

Table 111 USA Flash Key Commands

COMMAND	SUB-COMMAND	DESCRIPTION
Flash		Put a current call on hold to place a second call. After the second call is successful, press the flash key again to have a three-way conference call. Put a current call on hold to answer an incoming call.
Flash	*98#	Transfer the call to another phone.

## USA Call Hold

Call hold allows you to put a call (**A**) on hold by pressing the flash key.

If you have another call, press the flash key to switch back and forth between caller **A** and **B** by putting either one on hold.

If you hang up the phone but a caller is still on hold, there will be a remind ring.

## USA Call Waiting

This allows you to place a call on hold while you answer another incoming call on the same telephone (directory) number.

If there is a second call to your telephone number, you will hear a call waiting tone.

Press the flash key to put the first call on hold and answer the second call.

## USA Call Transfer

Do the following to transfer an incoming call (that you have answered) to another phone.

- 1 Press the flash key to put the caller on hold.
- 2 When you hear the dial tone, dial **\*\*98#** followed by the number to which you want to transfer the call.
- 3 After you hear the ring signal or the second party answers it, hang up the phone.

## USA Three-Way Conference

Use the following steps to make three-way conference calls.

- 1 When you are on the phone talking to someone (party A), press the flash key to put the caller on hold and get a dial tone.
- 2 Dial a phone number directly to make another call (to party B).
- 3 When party B answers the second call, press the flash key to create a three-way conversation.
- 4 Hang up the phone to drop the connection.

- 5 If you want to separate the activated three-way conference into two individual connections (with party A on-line and party B on hold), press the flash key.
- 6 If you want to go back to the three-way conversation, press the flash key again.
- 7 If you want to separate the activated three-way conference into two individual connections again, press the flash key. This time the party B is on-line and party A is on hold.

#### 19.10.2.4 Phone Functions Summary

The following table shows the key combinations you can enter on your phone's keypad to use certain features.

Table 112 Phone Functions Summary

ACTION	FUNCTION	DESCRIPTION
*98#	Call transfer	Transfer a call to another phone. See <a href="#">Section 19.10.2.2 on page 288</a> (Europe type) and <a href="#">Section 19.10.2.3 on page 289</a> (USA type).
*66#	Call return	Place a call to the last person who called you.
*95#	Enable Do Not Disturb	Use these to set your phone not to ring when someone calls you, or to turn this function off.
#95#	Disable Do Not Disturb	
*41#	Enable Call Waiting	Use these to allow you to put a call on hold when you are answering another, or to turn this function off.
#41#	Disable Call Waiting	
****	IVR	Use these to set up Interactive Voice Response (IVR). IVR allows you to record custom caller ringing tones (the sound a caller hears before you pick up the phone) and on hold tones (the sound someone hears when you put their call on hold).
####	Internal Call	Call the phone(s) connected to the Zyxel Device.
*82	One Shot Caller Display Call	Activate or deactivate caller ID for the next call only.
*67	One Shot Caller Hidden Call	

# CHAPTER 20

## Log

### 20.1 What You Need To Know

The following terms and concepts may help as you read this chapter.

#### Alerts and Logs

An alert is a type of log that warrants more serious attention. They include system errors, attacks (access control) and attempted access to blocked web sites. Some categories such as **System Errors** consist of both logs and alerts. You may differentiate them by their color in the **View Log** screen. Alerts display in red and logs display in black.

### 20.2 System Log

Use the **System Log** screen to see the system logs. You can filter the entries by selecting a severity level and/or category. Click **System Monitor > Log** to open the **System Log** screen.

**Figure 186** System Monitor > Log > System Log

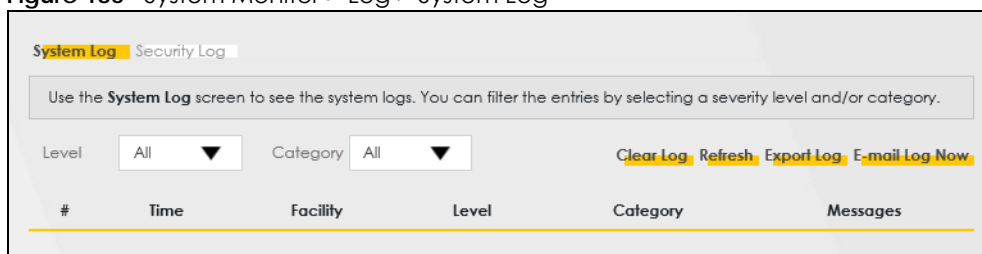

The following table describes the fields in this screen.

Table 113 System Monitor > Log > System Log

LABEL	DESCRIPTION
Level	Select a severity level from the drop-down list box. This filters search results according to the severity level you have selected. When you select a severity, the Zyxel Device searches through all logs of that severity or higher.
Category	Select the type of logs to display.
Clear Log	Click this to delete all the logs.
Refresh	Click this to renew the log screen.
Export Log	Click this to export the selected logs.
E-mail Log Now	Click this to send the log files to the email address you specify in the <b>Maintenance &gt; Log Setting</b> screen.
#	This field is a sequential value and is not associated with a specific entry.

Table 113 System Monitor &gt; Log &gt; System Log (continued)

LABEL	DESCRIPTION
Time	This field displays the time the log was recorded.
Facility	The log facility allows you to send logs to different files in the syslog server. Refer to the documentation of your syslog program for more details.
Level	This field displays the severity level of the log that the Zyxel Device is to send to this syslog server.
Category	This field displays the type of the log.
Messages	This field states the reason for the log.

## 20.3 Security Log

Use the **Security Log** screen to see the security-related logs for the categories that you select. You can filter the entries by selecting a severity level and/or category. Click **System Monitor > Log > Security Log** to open the following screen.

Figure 187 System Monitor &gt; Log &gt; Security Log

System Log **Security Log**

Use the **Security Log** screen to see the security-related logs for the categories that you select. You can filter the entries by selecting a severity level and/or category.

Level  Category  [Clear Log](#) [Refresh](#) [Export Log](#) [E-mail Log Now](#)

#	Time	Facility	Level	Category	Messages
---	------	----------	-------	----------	----------

The following table describes the fields in this screen.

Table 114 System Monitor &gt; Log &gt; Security Log

LABEL	DESCRIPTION
Level	Select a severity level from the drop-down list box. This filters search results according to the severity level you have selected. When you select a severity, the Zyxel Device searches through all logs of that severity or higher.
Category	Select the type of logs to display.
Clear Log	Click this to delete all the logs.
Refresh	Click this to renew the log screen.
Export Log	Click this to export the selected logs.
E-mail Log Now	Click this to send the log files to the email address you specify in the <b>Maintenance &gt; Log Setting</b> screen.
#	This field is a sequential value and is not associated with a specific entry.
Time	This field displays the time the log was recorded.
Facility	The log facility allows you to send logs to different files in the syslog server. Refer to the documentation of your syslog program for more details.
Level	This field displays the severity level of the log that the Zyxel Device is to send to this syslog server.
Category	This field displays the type of the log.
Messages	This field states the reason for the log.

# CHAPTER 21

## Traffic Status

### 21.1 Traffic Status Overview

Use the **Traffic Status** screens to look at the network traffic status and statistics of the WAN/LAN interfaces and NAT.

#### 21.1.1 What You Can Do in this Chapter

- Use the **WAN** screen to view the WAN traffic statistics ([Section 21.2 on page 294](#)).
- Use the **LAN** screen to view the LAN traffic statistics ([Section 21.3 on page 296](#)).

### 21.2 WAN Status

Click **System Monitor > Traffic Status** to open the **WAN** screen. The figures in this screen show the number of bytes received and sent through the Zyxel Device's WAN interface. The table below shows packet statistics for each WAN interface.

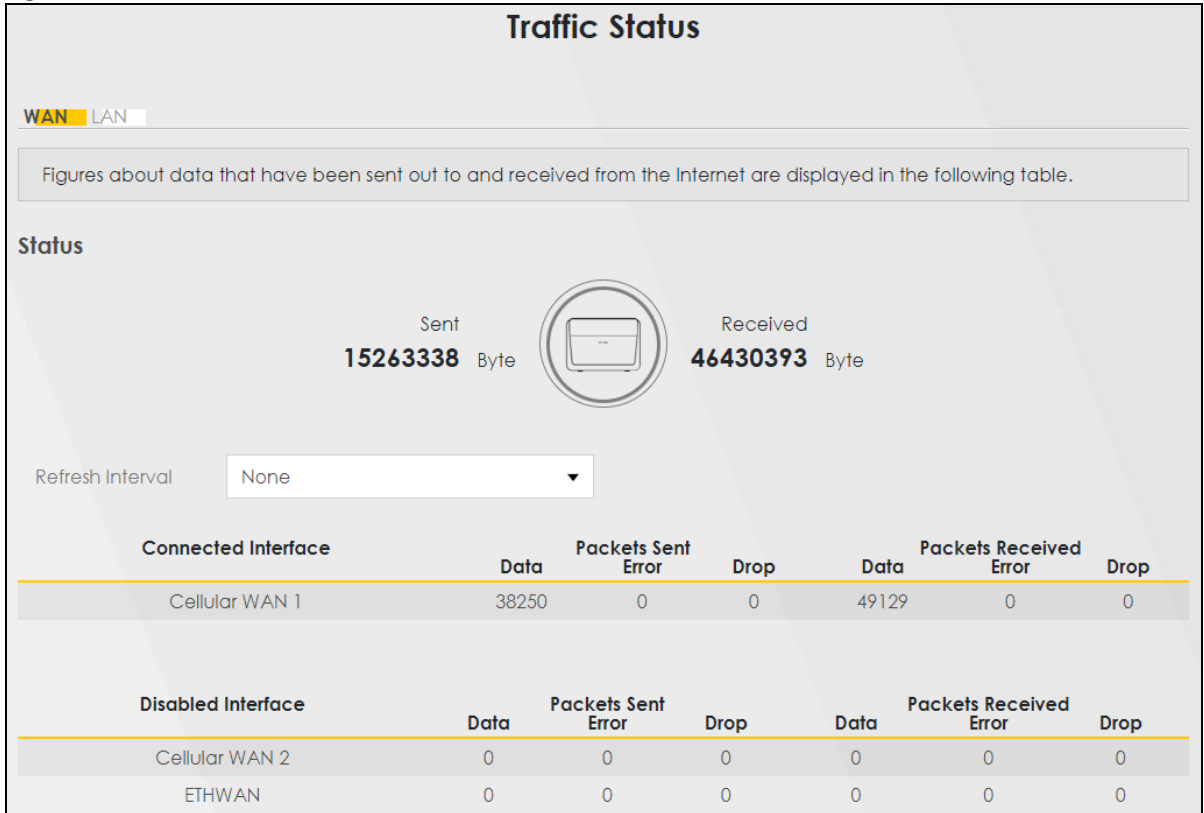
**Figure 188** System Monitor > Traffic Status > WAN

The following table describes the fields in this screen.

Table 115 System Monitor &gt; Traffic Status &gt; WAN

LABEL	DESCRIPTION
Refresh Interval	Select how often you want the Zyxel Device to update this screen.
Connected Interface	This shows the name of the WAN interface that is currently connected.
Packets Sent	
Data	This indicates the number of transmitted packets on this interface.
Error	This indicates the number of frames with errors transmitted on this interface.
Drop	This indicates the number of outgoing packets dropped on this interface.
Packets Received	
Data	This indicates the number of received packets on this interface.
Error	This indicates the number of frames with errors received on this interface.
Drop	This indicates the number of received packets dropped on this interface.
Disabled Interface	This shows the name of the WAN interface that is currently disabled.
Packets Sent	
Data	This indicates the number of transmitted packets on this interface.
Error	This indicates the number of frames with errors transmitted on this interface.
Drop	This indicates the number of outgoing packets dropped on this interface.
Packets Received	

Table 115 System Monitor &gt; Traffic Status &gt; WAN (continued)

LABEL	DESCRIPTION
Data	This indicates the number of received packets on this interface.
Error	This indicates the number of frames with errors received on this interface.
Drop	This indicates the number of received packets dropped on this interface.

## 21.3 LAN Status

Click **System Monitor > Traffic Status > LAN** to open the following screen. This screen allows you to view packet statistics for each LAN or WLAN interface on the Zyxel Device.

Figure 189 System Monitor &gt; Traffic Status &gt; LAN

The screenshot shows the 'Traffic Status' page with the 'LAN' tab selected. It includes a refresh interval dropdown set to '30 seconds' and two tables of statistics.

Interface	LAN	2.4G WLAN	5G WLAN
Bytes Sent	589466	1060	0
Bytes Received	480594	2664	0

Interface	LAN	2.4G WLAN	5G WLAN
Sent (Packet)	Data	2836	5
	Error	0	0
	Drop	0	0
Received (Packet)	Data	5096	28
	Error	0	8
	Drop	6	0

The following table describes the fields in this screen.

Table 116 System Monitor &gt; Traffic Status &gt; LAN

LABEL	DESCRIPTION
Refresh Interval	Select how often you want the Zyxel Device to update this screen.
Interface	This shows the LAN or WLAN interface.
Bytes Sent	This indicates the number of bytes transmitted on this interface.
Bytes Received	This indicates the number of bytes received on this interface.
Interface	This shows the LAN or WLAN interfaces.
Sent (Packets)	
Data	This indicates the number of transmitted packets on this interface.
Error	This indicates the number of frames with errors transmitted on this interface.
Drop	This indicates the number of outgoing packets dropped on this interface.
Received (Packets)	



Table 116 System Monitor > Traffic Status > LAN (continued)

LABEL	DESCRIPTION
Data	This indicates the number of received packets on this interface.
Error	This indicates the number of frames with errors received on this interface.
Drop	This indicates the number of received packets dropped on this interface.

# CHAPTER 22

## VoIP Status

### 22.1 VoIP Status Screen

Click **System Monitor > VoIP Status** to open the following screen. You can view the Voice over IP (VoIP) registration, current call status and phone numbers in this screen.

**Figure 190** System Monitor > VoIP Status

Information, such as whether a SIP account is registered and the total call volume made by a SIP account, can be viewed in the page.

Poll Interval  sec [Set Interval](#) [Stop](#)

(s)

#### SIP Status

Account	Register Action	Registration	Registration Time	URI	Message Waiting	Last Incoming Number	Last Outgoing Number
1	<input type="checkbox"/>	Disabled		ChangeMe@ChangeMe	No		

#### Call Status

Account	Duration	Status	Call Type	Codec	From Phone Port Type	To Phone Port Type	Peer Number

#### Phone Status

Phone	Outgoing Number	Incoming Number	Hook Status
Phone 1	ChangeMe	ChangeMe	On-hook

The following table describes the labels in this screen.

**Table 117** System Monitor > VoIP Status

LABEL	DESCRIPTION
Poll Interval	Enter the number of seconds the Device needs to wait before updating this screen and then click <b>Set Interval</b> . Click <b>Stop</b> to have the Device stop updating this screen.
SIP Status	
Account	This column displays each SIP account in the Device.
Register Action	Click on this switch to register/unregister the SIP account. This switch will turn blue if a registration attempt is successful; otherwise, it will revert to its unregistered setting. Unregistering an account does not delete the SIP account itself, but removes the mapping between your SIP identity and your IP address or domain name.

Table 117 System Monitor &gt; VoIP Status (continued)

LABEL	DESCRIPTION
Registration	This field displays the current registration status of the SIP account. You can change this in the Status screen. Registered – The SIP account is registered with a SIP server. Not Registered – The last time the Device tried to register the SIP account with the SIP server, the attempt failed. The Device automatically tries to register the SIP account when you turn on the Device or when you activate it. Inactive – The SIP account is not active. You can activate it in <b>VoIP &gt; SIP &gt; SIP Account</b> .
Registration Time	This field displays the last time the Device successfully registered the SIP account. The field is blank if the Device has never successfully registered this account.
URI	This field displays the account number and service domain of the SIP account. You can change these in the <b>VoIP &gt; SIP</b> screen.
Message Waiting	This field indicates whether or not there are any messages waiting for the SIP account.
Last Incoming Number	This field displays the last number that called the SIP account. The field is blank if no number has ever dialed the SIP account.
Last Outgoing Number	This field displays the last number the SIP account called. The field is blank if the SIP account has never dialed a number.
Call Status	
Account	This column displays each SIP account in the Device.
Duration	This field displays how long the current call has lasted.
Status	<p>This field displays the current state of the phone call.</p> <p><b>Idle</b> – There are no current VoIP calls, incoming calls or outgoing calls being made.</p> <p><b>Dial</b> – The callee's phone is ringing.</p> <p><b>Ring</b> – The phone is ringing for an incoming VoIP call.</p> <p><b>Process</b> – There is a VoIP call in progress.</p> <p><b>DISC</b> – The callee's line is busy, the callee hung up or your phone was left off the hook.</p>
Call Type	<p>This field displays the call direction type of the current VoIP call. <b>Outgoing Call</b> – It is a SIP VoIP call made by local phone ports, and this SIP account is able to issue a (SIP-based) call setup to the SIP account of remote peers for a VoIP call establishment. This (SIP-based) call setup signal is sent to the SIP server first, and then the SIP server would relay it to the target peer after correctly resolving and locating the target peer. During the call setup (signaling) phase, Calling state is displayed in the Status field, and it turns to InCall state once the call is successfully established.</p> <p><b>Incoming Call</b> – It is a SIP VoIP call made or originated by remote SIP accounts to connect to this local SIP account. One or more local phone ports can be configured to receive this type of call, see the Incoming Number below, and all of them should begin to ring during the call setup (signaling phase), see the Status above. Once some remote SIP accounts start to ring one local phone, answer by off-hook to the call, and the call is successfully established. The other ringing local phone ports will stop ringing and turning to InCall state in the Status field.</p> <p><b>Internal Call</b> – It is a local VoIP call between two different local phone ports. No SIP signaling is needed and thus no SIP server is involved to establish this type of call. This type of call is established through the Internal and Non-SIP local setup signaling procedure between the call- originating and call-terminating local phone ports. In general, one or more local phone ports can be designed to receive this type of call, and once any of the ringing phones answer the call, the other ringing ones will stop ringing. During the call setup phase (signaling phase), Calling state is displayed in Status field, and turns to InCall state once the call is successfully established.</p>
Codec	This field displays what voice codec is being used for a current VoIP call through a phone port.

Table 117 System Monitor &gt; VoIP Status (continued)

LABEL	DESCRIPTION
From Phone Port Type	This field displays the phone ports type used to originate, start, or create the current VoIP call. Two possible type values will be displayed here: SIP – For the current call which is categorized as Incoming Call in the Call Type field, this field will show the type SIP. FXS – As for the other cases: Outgoing Call and Internal Call, this field will show the corresponding local phone port type: FXS, the legacy analog phone port on the device.
To Phone Port Type	This field displays the phone ports type used to receive the current VoIP call. Three possible type values will be displayed here: SIP – For the current call which is categorized as Outgoing Call in the Call Type field, this field will show the type SIP. FXS and Unknown – As for the other cases: Incoming Call and Internal Call, this field will show the corresponding local phone port type: FXS, the legacy analog phone port on the device. While the call is established, this field shows Unknown during the call setup phase (signaling phase). This is because one or more local phone ports can be configured or designed to receive these two types of calls, see the Call Type above, and the local phone port will answer the call that hasn't been determined yet at that time.
Peer Number	This field displays the SIP number of the party that is currently engaged in a VoIP call through a phone port.
Phone Status	
Phone	This field displays the name of a phone port on the Device.
Outgoing Number	This field displays the SIP number that you use to make calls on this phone port.
Incoming Number	This field displays the SIP number that you use to receive calls on this phone port.
Hook Status	<p>This field displays whether the phone is in the on or off hook status.</p> <p><b>Off-Hook</b> means a telephone connected to one of the phone port has its receiver off the hook.</p> <p><b>On-Hook</b> means a telephone connected to one of the phone port has its receiver on the hook.</p>

# CHAPTER 23

## ARP Table

### 23.1 ARP Table Overview

Address Resolution Protocol (ARP) is a protocol for mapping an Internet Protocol (IP) address to a physical machine address, known as a Media Access Control (MAC) address, on the local area network.

An IP version 4 address is 32 bits long. MAC addresses are 48 bits long. The ARP table maintains an association between each MAC address and its corresponding IP address.

#### 23.1.1 How ARP Works

When an incoming packet destined for a host device on a local area network arrives at the device, the device's ARP program looks in the ARP table and, if it finds the address, sends it to the device.

If no entry is found for the IP address, ARP broadcasts the request to all the devices on the LAN. The device fills in its own MAC and IP address in the sender address fields, and puts the known IP address of the target in the target IP address field. In addition, the device puts all ones in the target MAC field (FF.FF.FF.FF.FF.FF is the Ethernet broadcast address). The replying device (which is either the IP address of the device being sought or the router that knows the way) replaces the broadcast address with the target's MAC address, swaps the sender and target pairs, and unicasts the answer directly back to the requesting machine. ARP updates the ARP table for future reference and then sends the packet to the MAC address that replied.

### 23.2 ARP Table

Use the ARP table to view the IPv4-to-MAC address mappings for each device connected to the Zyxel Device. The neighbor table shows the IPv6-to-MAC address mappings of each IPv6 neighbor. To open this screen, click **System Monitor > ARP Table**.

Figure 191 System Monitor &gt; ARP Table

### ARP Table

Address Resolution Protocol (ARP) is a protocol for mapping an Internet Protocol address (IP address) to a physical machine address, also known as a Media Access Control or MAC address, on the local area network.

The ARP table maintains an association between each MAC address and its corresponding IP address.

Use the ARP table to view the IPv4-to-MAC address mapping(s) for the LAN. The neighbor table shows the IPv6-to-MAC address mapping(s) of each neighbor.

IPv4 ARP Table

#	IPv4 Address	MAC Address	Device
1	192.168.1.100	08:00:27:00:00:01	br0
2	192.168.1.101	08:00:27:00:00:02	br0

IPv6 Neighbour Table

#	IPv6 Address	MAC Address	Device
1	fe80::200:0:0:0:0:0:0:0	08:00:27:00:00:01	br0
2	fe80::200:0:0:0:0:0:0:0	08:00:27:00:00:02	br0

The following table describes the labels in this screen.

Table 118 System Monitor &gt; ARP Table

LABEL	DESCRIPTION
#	This is the ARP table entry number.
IPv4 / IPv6 Address	This is the learned IPv4 or IPv6 IP address of a device connected to the Zyxel Device.
MAC Address	This is the MAC address of the connected device with the listed IP address.
Device	This is the type of interface used by the connected device. You can click the device type to go to its configuration screen.

# CHAPTER 24

## Routing Table

### 24.1 Routing Table Overview

Routing is based on the destination address only and the Zyxel Device takes the shortest path to forward a packet.

### 24.2 Routing Table

The table below shows IPv4 and IPv6 routing information. The IPv4 subnet mask is '255.255.255.255' for a host destination and '0.0.0.0' for the default route. The gateway address is written as '\*'(IPv4)('/: '(IPv6) if none is set.

Click **System Monitor > Routing Table** to open the following screen.

Figure 192 System Monitor > Routing Table

### Routing Table

Routing is based on the destination address only and the Zyxel Device takes the shortest path to forward a packet.

The table below shows IPv4 and IPv6 routing information. The IPv4 subnet mask is '255.255.255.255' for a host destination and '0.0.0.0' for the default route. The gateway address is written as '\*\*'(IPv4)':'(IPv6) if none is set.

**Destination:**This indicates the destination IPv4 address or IPv6 address and prefix of this route.  
**Gateway:**This indicates the IPv4 address or IPv6 address of the gateway that helps forward this route's traffic.  
**Subnet Mask:**This indicates the destination subnet mask of the IPv4 route.  
**Flag:**This indicates the route status.  
 U-Up: The route is up.  
 I-Reject: The route is blocked and will force a route lookup to fail.  
 G-Gateway: The route uses a gateway to forward traffic.  
 H-Host: The target of the route is a host.  
 R-Reinstate: The route is reinstated for dynamic routing.  
 D-Dynamic (redirect): The route is dynamically installed by a routing daemon or redirect.  
 M-Modified (redirect): The route is modified from a routing daemon or redirect.  
**Metric:**The metric represents the "cost of transmission". A router determines the best route for transmission by choosing a path with the lowest "cost". The smaller the number, the lower the "cost".  
**Interface:**This indicates the name of the interface through which the route is forwarded.

---

IPv4 Routing Table

Destination	Gateway	Subnet Mask	Flag	Metric	Interface
0.0.0.0	0.0.0.0	255.255.0.0	U	0	lo
192.168.1.0/24	0.0.0.0	255.255.255.0	U	0	br0
192.168.1.1	0.0.0.0	255.0.0.0	U	0	br0

---

IPv6 Routing Table

Destination	Gateway	Flag	Metric	Interface
fe80::/64	::	U	256	eth0
fe80::/64	::	U	256	eth0.1
fe80::/64	::	U	256	eth0.2
fe80::/64	::	U	256	eth0.3
fe80::/64	::	U	256	eth0.4
fe80::/64	::	U	256	nas10
fe80::/64	::	U	256	br0
fe80::/64	::	U	256	ra0
fe80::/64	::	U	256	ra1
fe80::/64	::	U	256	ra2
fe80::/64	::	U	256	ra3
fe80::/64	::	U	256	rai0
fe80::/64	::	U	256	rai1
fe80::/64	::	U	256	rai2
fe80::/64	::	U	256	rai3
fe80::/64	::	U	256	rai5
::1/128	::	U	0	lo

The following table describes the labels in this screen.

Table 119 System Monitor > Routing Table

LABEL	DESCRIPTION
IPv4 / IPv6 Routing Table	
Destination	This indicates the destination IPv4 address or IPv6 address and prefix of this route.
Gateway	This indicates the IPv4 address or IPv6 address of the gateway that helps forward this route's traffic.
Subnet Mask	This indicates the destination subnet mask of the IPv4 route.



Table 119 System Monitor &gt; Routing Table (continued)

LABEL	DESCRIPTION
Flag	<p>This indicates the route status.</p> <p><b>U-Up:</b> The route is up.</p> <p><b>!-Reject:</b> The route is blocked and will force a route lookup to fail.</p> <p><b>G-Gateway:</b> The route uses a gateway to forward traffic.</p> <p><b>H-Host:</b> The target of the route is a host.</p> <p><b>R-Reinstate:</b> The route is reinstated for dynamic routing.</p> <p><b>D-Dynamic (redirect):</b> The route is dynamically installed by a routing daemon or redirect.</p> <p><b>M-Modified (redirect):</b> The route is modified from a routing daemon or redirect.</p>
Metric	<p>The metric represents the "cost of transmission." A router determines the best route for transmission by choosing a path with the lowest "cost." The smaller the number, the lower the "cost."</p>
Interface	<p>This indicates the name of the interface through which the route is forwarded.</p> <ul style="list-style-type: none"> <li>• <b>brx</b> indicates a LAN interface where x can be 0 – 3 to represent LAN1 to LAN4 respectively.</li> <li>• <b>ethx</b> indicates an Ethernet WAN interface using IPoE or in bridge mode.</li> <li>• <b>ppp0</b> indicates a WAN interface using PPPoE.</li> <li>• <b>wlx</b> indicates a wireless interface where x can be 0 – 1.</li> </ul>

# CHAPTER 25

## WLAN Station Status

### 25.1 WLAN Station Status Overview

Click **System Monitor > WLAN Station Status** to open the following screen. Use this screen to view information and status of the WiFi stations (WiFi clients) that are currently associated with the Zyxel Device. Being associated means that a WiFi client (for example, your computer with a WiFi network card installed) has connected successfully to an AP (or WiFi router) using the same SSID, channel, and WiFi security settings.

**Figure 193** System Monitor > WLAN Station Status

WLAN Station Status lists associated WiFi clients.

WLAN 2.4G Station Status

#	MAC Address	Rate (Mbps)	RSSI (dBm)	SNR	Level
---	-------------	-------------	------------	-----	-------

WLAN 5G Station Status

#	MAC Address	Rate (Mbps)	RSSI (dBm)	SNR	Level
---	-------------	-------------	------------	-----	-------

WLAN EasyMesh Station Status

Note  
D/M/RSSI(dBm) is the abbreviation of Distance/Medium/RSSI(dBm)

#	Agent backhaul STA	D/M/RSSI(dBm)	BSSINFO(BSSID/SSID/Channel)	Connected STA MAC
---	--------------------	---------------	-----------------------------	-------------------

The following table describes the labels in this screen.

Table 120 System Monitor > WLAN Station Status

LABEL	DESCRIPTION
#	This is the index number of an associated WiFi station.
IP	This field displays the IP address of an associated WiFi station.
MAC Address	This field displays the MAC address of an associated WiFi station.
SSID	This field displays the SSID (Service Set Identifier) this WiFi station is associated with.
Rate (Mbps)	This field displays the transmission rate of WiFi traffic between an associated WiFi station and the Zyxel Device.

Table 120 System Monitor &gt; WLAN Station Status (continued)

LABEL	DESCRIPTION
RSSI (dBm)	<p>The RSSI (Received Signal Strength Indicator) field shows the WiFi signal strength of the station's WiFi connection.</p> <p>The normal range is -30dBm to -79dBm. If the value drops below -80dBm, try moving the associated WiFi station closer to the Zyxel Device to get better signal strength.</p>
SNR	<p>The Signal-to-Noise Ratio (SNR) is the ratio between the received signal power and the received noise power. The greater the number, the better the quality of WiFi.</p> <p>The normal range is 15 to 40. If the value drops below 15, try moving the associated WiFi station closer to the Zyxel Device to get better quality WiFi.</p>
Level	<p>This field displays a number which represents the strength of the WiFi signal between an associated WiFi station and the Zyxel Device. The Zyxel Device uses the RSSI and SNR values to determine the strength of the WiFi signal.</p> <p>5 means the Zyxel Device is receiving an excellent WiFi signal.</p> <p>4 means the Zyxel Device is receiving a very good WiFi signal.</p> <p>3 means the Zyxel Device is receiving a weak WiFi signal,</p> <p>2 means the Zyxel Device is receiving a very weak WiFi signal.</p> <p>1 means the Zyxel Device is not receiving a WiFi signal.</p>
Channel	<p>This field displays the wireless channel bandwidth of an associated WiFi station.</p>

# CHAPTER 26

## Cellular WAN Status

### 26.1 Cellular WAN Status Overview

View the cellular connection details and signal strength value that you can use as reference for positioning the Zyxel Device, as well as SIM card and module information.

### 26.2 Cellular WAN Status

To open this screen, click **System Monitor > Cellular WAN Status**. Cellular information is available on this screen only when you insert a valid SIM card in the Zyxel Device.

Figure 194 System Monitor &gt; Cellular WAN Status

### Cellular WAN Status

View the LTE connection details and signal strength value that you can use as reference for positioning the Zyxel Device, as well as SIM card and module information.

Cellular information is available on this screen only when you insert a valid SIM card in the Zyxel Device.

Refresh Interval:

#### Module Information

IMEI	351909770000518
Module SW Version	RG500LEUACR04A01M1G

#### SIM Status

SIM Card Status	Available
IMSI	466924293329988
ICCID	89886920042933299880
PIN Protection	Disable
PIN Remaining Attempts	3

#### IP Passthrough Status

IP Passthrough Enable	Disable
-----------------------	---------

#### Cellular Status

Cellular Status	Up
Data Roaming	Disable
Operator	Chunghwa Telecom
PLMN	46692
Antenna Status	Internal

#### Service Information

Access Technology	LTE
Band	B7
RSSI (dBm)	-91
Cell ID	88587328
Physical Cell ID	164
UL Bandwidth (MHz)	20M
DL Bandwidth (MHz)	20M
RFCN	3050
RSRP (dBm)	-100
RSRQ (dB)	-9
SINR (dB)	11
RSCP	0
EcNo	0
Primary Scrambling Code	
LAC	N/A
RAC	N/A
BSIC	N/A
TAC	13700
NR Physical Cell ID	N/A
NR RSRP	0
NR RSRQ	0
NR SINR (dBm)	0

The following table describes the labels in this screen.

Table 121 System Monitor &gt; Cellular WAN Status

LABEL	DESCRIPTION
Refresh Interval	Select the time interval the Zyxel Device will check and refresh the fields shown on this screen. Select <b>None</b> to stop detection.
Module Information	
IMEI	This shows the International Mobile Equipment Identity of the Zyxel Device.
Module SW Version	This shows the software version of the cellular module.
SIM Status	
SIM Card Status	This displays the SIM card status:  <b>None</b> – the Zyxel Device does not detect that there is a SIM card inserted. <b>Waiting SIM Available</b> – the SIM card is detected but not available yet. <b>Available</b> – the SIM card could either have or doesn't have PIN code security. <b>Locked</b> – the SIM card has PIN code security, but you did not enter the PIN code yet. <b>Blocked</b> – you entered an incorrect PIN code too many times, so the SIM card has been locked; call the ISP for a PUK (Pin Unlock Key) to unlock the SIM card. <b>Error</b> - the Zyxel Device detected that the SIM card has errors.
IMSI	This displays the International Mobile Subscriber Identity (IMSI) of the installed SIM card. An IMSI is a unique ID used to identify a mobile subscriber in a mobile network.
ICCID	Integrated Circuit Card Identifier ( <b>ICCID</b> ). This is the serial number of the SIM card.
PIN Protection	A PIN (Personal Identification Number) code is a key to a SIM card. Without the PIN code, you cannot use the SIM card.  Shows <b>Enable</b> if the service provider requires you to enter a PIN to use the SIM card.  Shows <b>Disable</b> if the service provider lets you use the SIM without inputting a PIN.
PIN Remaining Attempts	This is how many more times you can try to enter the PIN code before the ISP blocks your SIM card.
IP Passthrough Status	
IP Passthrough Enable	This displays if IP Passthrough is enabled on the Zyxel Device.  IP Passthrough allows a LAN computer on the local network of the Zyxel Device to have access to web services using the public IP address. When IP Passthrough is configured, all traffic is forwarded to the first LAN computer on the local network and will not go through NAT.
IP Passthrough Mode	This displays the IP Passthrough mode.  This displays <b>Dynamic</b> and the Zyxel Device will allow traffic to be forwarded to the first LAN computer requesting an IP address from the Zyxel Device.  This displays <b>Fixed</b> and the Zyxel Device will allow traffic to be forwarded to a specific LAN computer on the local network of the Zyxel Device.
Cellular Status	
Cellular Status	This displays the status of the cellular Internet connection.
Data Roaming	This displays if data roaming is enabled on the Zyxel Device.  Data roaming is to use your Zyxel Device in an area which is not covered by your service provider. Enable roaming to ensure that your Zyxel Device is kept connected to the Internet when you are traveling outside the geographical coverage area of the network to which you are registered.
Operator	This displays the name of the service provider.

Table 121 System Monitor &gt; Cellular WAN Status (continued)

LABEL	DESCRIPTION
PLMN	This displays the PLMN number.
Antenna Status	This displays <b>Internal</b> when the <b>INT EXT</b> switch is set to <b>INT</b> . Use the Zyxel Device's internal antenna to get cellular signal.  This displays <b>External</b> when the <b>INT EXT</b> switch is set to <b>EXT</b> . Connect external antennas to the Zyxel Device's to strengthen the cellular signal. See <a href="#">Section 2.4 on page 34</a> for more information.
Service Information	
Access Technology	This displays the type of the mobile network (such as LTE, UMTS, GSM) to which the Zyxel Device is connecting.
Band	This displays the current cellular band of your Zyxel Device.
RSSI (dBm)	This displays the strength of the WiFi signal between an associated wireless station and an AP.  The normal range is $-30$ dBm to $-79$ dBm. If the value drops below $-80$ dBm, try moving the associated wireless station closer to the Zyxel Device to get better signal strength.
Cell ID	This shows the cell ID, which is a unique number used to identify the Base Transceiver Station to which the Zyxel Device is connecting.  The value depends on the Current Access Technology: <ul style="list-style-type: none"> <li>For GPRS, it is the Cell Identity as specified in 3GPP-TS.25.331.</li> <li>For UMTS, it is the Cell Identity as defined in SIB3 3GPP-TS.25.331, 3GPP-TS.24.008.</li> <li>For LTE, it is the 28-bit binary number Cell Identity as specified in SIB1 in 3GPP-TS.36.331.</li> </ul> The value is '0' (zero) or 'N/A' if there is no network connection.
Physical Cell ID	This shows the Physical Cell ID (PCI), which are queries and replies between the Zyxel Device and the mobile network it is connecting to. The normal range is 1 to 504.
UL Bandwidth (MHz)	This shows the cellular channel bandwidth from the Zyxel Device to the base station. According to 3GPP specifications, the bandwidths defined by the standard are 1.4, 3, 5, 10, 15, and 20 MHz. The wider the bandwidth the higher the throughput.
DL Bandwidth (MHz)	This shows the cellular channel bandwidth from the base station to the Zyxel Device. According to 3GPP specifications, the bandwidths defined by the standard are 1.4, 3, 5, 10, 15, and 20 MHz. The wider the bandwidth the higher the throughput.
RFCN	This displays the Radio Frequency Channel Number of DL carrier frequency used by the mobile network to which the Zyxel Device is connecting.  The value depends on the Current Access Technology: <ul style="list-style-type: none"> <li>For GPRS, it is the ARFCN (Absolute Radio-Frequency Channel Number) as specified in 3GPP-TS.45.005.</li> <li>For UMTS, it is the UARFCN (UTRA Absolute Radio-Frequency Channel Number) as specified in 3GPP-TS.25.101.</li> <li>For LTE, it is the EARFCN (E-UTRA Absolute Radio-Frequency Channel Number) as specified in 3GPP-TS.36.101.</li> </ul> The value is '0' (zero) or 'N/A' if there is no network connection.
RSRP (dBm)	This displays the Reference Signal Receive Power (RSRP), which is the average received power of all Resource Element (RE) that carry cell-specific Reference Signals (RS) within the specified bandwidth.  The received RSRP level of the connected E-UTRA cell, in dBm, is as specified in 3GPP-TS.36.214. The reporting range is specified in 3GPP-TS.36.133.  An undetectable signal is indicated by the lower limit, example $-140$ dBm.  This parameter is for LTE only. The normal range is $-30$ to $-140$ . The value is $-140$ if the Current Access Technology is not LTE. The value is 'N/A' if there is no network connection.

Table 121 System Monitor &gt; Cellular WAN Status (continued)

LABEL	DESCRIPTION
RSRQ (dB)	<p>This displays the Reference Signal Receive Quality (RSRQ), which is the ratio of RSRP to the E-UTRA carrier RSSI and indicates the quality of the received reference signal.</p> <p>The received RSRQ level of the connected E-UTRA cell, in 0.1 dB, is as specified in 3GPP-TS.36.214. An undetectable signal is indicated by the lower limit, example -240.</p> <p>This parameter is for LTE only. The normal range is -30 to -240. The value is -240 if the Current Access Technology is not LTE. The value is 'N/A' if there is no network connection.</p>
SINR (dB)	<p>This displays the Signal to Interference plus Noise Ratio (SINR) in dB. This is also a measure of signal quality and used by the UE (User Equipment) to calculate the Channel Quality Indicator (CQI) that it reports to the network. A negative value means more noise than signal.</p>
RSCP	<p>This displays the Received Signal Code Power, which measures the power of channel used by the Zyxel Device.</p> <p>The received signal level, in dBm, is of the CPICH channel (Ref. 3GPP TS 25.133). An undetectable signal is indicated by the lower limit, example -120 dBm.</p> <p>This parameter is for UMTS only. The normal range is -30 to -120. The value is -120 if the Current Access Technology is not UMTS. The value is 'N/A' if there is no network connection.</p>
EcNo	<p>This displays the ratio (in dB) of the received energy per chip and the interference level.</p> <p>The measured EcNo is in 0.1 dB and is received in the downlink pilot channel. An undetectable signal is indicated by the lower limit, for example, -240 dB.</p> <p>This parameter is for UMTS only. The normal range is -30 to -240. The value is -240 if the Current Access Technology is not UMTS or there is no network connection.</p>
Primary Scrambling Code	<p>This displays a unique scrambling code used by the Nebula Device to identify a base station in a cellular network.</p> <p>A primary scrambling code is the product of the scrambling code and 16. Therefore, the primary scrambling code set contains all multiples of 16 from 0 through 8176.</p> <p>This only appears in UMTS mode. Otherwise, this field is blank.</p>
LAC	<p>This displays the 2-octet Location Area Code (LAC), which is used to identify a location area within a PLMN.</p> <p>The LAC of the connected cell is as defined in SIB 1 [3GPP-TS.25.331]. The concatenation of PLMN ID (MCC+MNC) and LAC uniquely identifies the LAI (Location Area ID) [3GPP-TS.23.003].</p> <p>This parameter is for UMTS or GPRS. The value is '0' (zero) if the Current Access Technology is not UMTS or GPRS. The value is 'N/A' if there is no network connection.</p>
RAC	<p>This displays the RAC (Routing Area Code), which is used in mobile network "packet domain service" (PS) to identify a routing area within a location area.</p> <p>In a mobile network, it uses LAC (Location Area Code) to identify the geographical location for the old 3G voice only service, and use RAC to identify the location of data service like HSDPA or LTE.</p> <p>The RAC of the connected UTRAN cell is as defined in SIB 1 [3GPP-TS.25.331]. The concatenation of PLMN ID (MCC+MNC), LAC, and RAC uniquely identifies the RAI (Routing Area ID) [3GPP-TS.23.003].</p> <p>This parameter is for UMTS or GPRS. The value is '0' (zero) if the Current Access Technology is not UMTS or GPRS. The value is 'N/A' if there is no network connection.</p>
BSIC	<p>The Base Station Identity Code (BSIC), which is a code used in GSM to uniquely identify a base station.</p> <p>This parameter is for GPRS only. The value is '0' (zero) if the Current Access Technology is not GPRS. The value is 'N/A' if there is no network connection.</p>



Table 121 System Monitor &gt; Cellular WAN Status (continued)

LABEL	DESCRIPTION
TAC	This displays the Tracking Area Code (TAC), which is used to identify the country of a mobile subscriber.  The physical cell ID of the connected E-UTRAN cell, is as specified in 3GPP-TS.36.101.  This parameter is for LTE only. The value is '0' (zero) or 'N/A' if the Current Access Technology is not LTE or there is no network connection.
SINR	This displays the Signal to Interference plus Noise Ratio (SINR) in dB. This is also a measure of signal quality and used by the UE (User Equipment) to calculate the Channel Quality Indicator (CQI) that it reports to the network. A negative value means more noise than signal.
CQI	This displays the Channel Quality Indicator (CQI). It is an indicator carrying the information on how good/bad the communication channel quality is.
MCS	MCS stands for modulation coding scheme. The base station selects MCS based on current radio conditions. The higher the MCS the more bits can be transmitted per time unit.
RI	This displays the Rank Indication, one of the control information that a UE will report to eNodeB (Evolved Node-B) on either PUCCH (Physical Uplink Control Channel) or PUSCH (Physical Uplink Shared Channel) based on uplink scheduling.
PMI	This displays the Precoding Matrix Indicator (PMI).  PMI is for transmission modes 4 (closed loop spatial multiplexing), 5 (multi-user MIMO), and 6 (closed loop spatial multiplexing using a single layer).  PMI determines how cellular data are encoded for the antennas to improve the downlink rate.
Neighbour Cells	This displays the type of the neighbor cell's carrier frequency detected by the Zyxel Device.  <b>Intra-Frequency</b> – when the current cell and target cell operate on the same carrier frequency. <b>Inter-Frequency</b> – when the current cell and target cell operate on different carrier frequencies.
#	This is the index number of the entry.
Connection Mode	This displays the connection mode of the detected neighbor cell.
NR Physical Cell ID	This shows the Physical Cell ID (PCI), which are queries and replies between the Zyxel Device and the 5G mobile network it is connecting to. The normal range is 0 to 503.
RFCN	This displays the Radio Frequency Channel Number (RFCN) of the detected base station. This is the carrier frequency designated by EARFCN. The range is 0 – 65535.
RSSI	This displays the Received Signal Strength Indicator (RSSI) level of the detected base station.  RSSI is an indicator of the signal strength, including signals and noises received by the target cell. The normal range is –30 dBm to –79 dBm.
NR RSRP	This displays the Reference Symbol Received Power (RSRP) level of the detected base station. RSRP is the average signal strength of the target station and is usually measured during a handover. The normal range is –140dBm to –44dBm.
NR RSRQ	This displays the Reference Signal Received Quality (RSRQ) level of the detected base station. RSRQ is the indicator of the signal quality of data transmission. The normal range is –24.0 dB to 0 dB.  RSRQ is defined as $RSRP/RSSI \cdot N$ . N is the number of resource blocks. A resource block is the smallest unit of radio resources allocated to a user and contains twelve sub-carriers in frequency and 0.5 ms in time.
NR SINR (dBm)	This displays the Signal to Interference plus Noise Ratio (SINR) in dB. This is also a measure of signal quality and used by the UE (User Equipment) to calculate the Channel Quality Indicator (CQI) that it reports to the 5G network. A negative value means more noise than signal.

# CHAPTER 27

## System

### 27.1 System Overview

Use this screen to name your Zyxel Device (Host) and give it an associated domain name for identification purposes.

### 27.2 System

Click **Maintenance > System** to open the following screen. Assign a unique name to the Zyxel Device so it can be easily recognized on your network. You can use up to 30 printable characters except [ " ], [ ` ], [ ' ], [ < ], [ > ], [ ^ ], [ \$ ], [ | ], [ & ], or [ ; ]. Spaces are allowed.

Figure 195 Maintenance > System

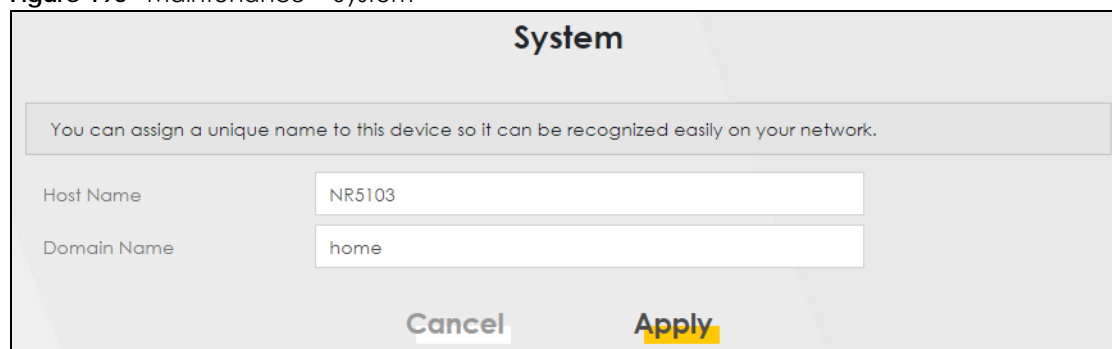

The screenshot shows a web interface titled "System". At the top, there is a message box that says "You can assign a unique name to this device so it can be recognized easily on your network." Below this, there are two input fields. The first is labeled "Host Name" and contains the text "NR5103". The second is labeled "Domain Name" and contains the text "home". At the bottom of the form, there are two buttons: "Cancel" and "Apply". The "Apply" button is highlighted in yellow.

The following table describes the labels in this screen.

Table 122 Maintenance > System

LABEL	DESCRIPTION
Host Name	Enter a descriptive host name for your Zyxel Device. You can use up to 30 printable characters except [ " ], [ ` ], [ ' ], [ < ], [ > ], [ ^ ], [ \$ ], [   ], [ & ], or [ ; ]. Spaces are allowed. For some models, the supported maximum input length is 16 alphanumeric characters.
Domain Name	Enter a domain name for your host Zyxel Device. You can use up to 30 printable characters except [ " ], [ ` ], [ ' ], [ < ], [ > ], [ ^ ], [ \$ ], [   ], [ & ], or [ ; ]. Spaces are allowed.
Cancel	Click <b>Cancel</b> to abandon this screen without saving.
Apply	Click <b>Apply</b> to save your changes.

# CHAPTER 28

## User Account

### 28.1 User Account Overview

In the **User Account** screen, you can view the settings of the “admin” that you use to log into the Zyxel Device to manage it.

### 28.2 User Account

Click **Maintenance > User Account** to open the following screen. Use this screen to create and manage user accounts and their privileges on the Zyxel Device.

**Figure 196** Maintenance > User Account

#	Active	User Name	Retry Times	Idle Timeout	Lock Period	Group	Modify
1	<input checked="" type="checkbox"/>	admin	3	60	5	Administrator	

The following table describes the labels in this screen.

**Table 123** Maintenance > User Account

LABEL	DESCRIPTION
Add New Account	Click this button to add a new user account (up to four <b>Administrator</b> accounts and four <b>User</b> accounts).
#	This is the index number.
Active	This indicates whether the user account is active or not. The checkbox is selected when the user account is enabled. It is cleared when it is disabled.
User Name	This displays the name of the account used to log into the Zyxel Device Web Configurator.
Retry Times	This displays the number of times consecutive wrong passwords can be entered for this account. 0 means there is no limit.
Idle Timeout	This displays the length of inactive time before the Zyxel Device will automatically log the user out of the Web Configurator.
Lock Period	This field displays the length of time a user must wait before attempting to log in again after a number of consecutive wrong passwords have been entered as defined in <b>Retry Times</b> .

Table 123 Maintenance &gt; User Account (continued)

LABEL	DESCRIPTION
Group	This field displays this user has <b>Administrator</b> privileges.
Modify	Click the <b>Edit</b> icon to configure the entry. Click the <b>Delete</b> icon to remove the entry.
Cancel	Click <b>Cancel</b> to restore your previously saved settings.
Apply	Click <b>Apply</b> to save your changes.

## 28.2.1 User Account Add or Edit

Add or change the name of the user account, set the security password and the retry times, and whether this user will have **Administrator** or **User** privileges. Click **Add New Account** or the **Edit** icon of an existing account in the **Maintenance > User Account** to open the following screen.

Figure 197 Maintenance &gt; User Account: Edit

The screenshot shows the 'User Account Edit' interface. It includes a back arrow in the top left corner. The title 'User Account Edit' is centered at the top. Below the title, there are several settings:

- Active:** A toggle switch that is currently turned on.
- User Name:** A text field containing the value 'admin'.
- Old Password:** A text field with a visibility icon (an eye) to its right.
- New Password:** A text field with a visibility icon (an eye) to its right.
- Verify Password:** A text field with a visibility icon (an eye) to its right.
- Retry Times:** A text field containing the value '3', with a range '(0-5), 0 : Not limit' to its right.
- Idle Timeout:** A text field containing the value '60', with a range 'Minute(s) (1-60)' to its right.
- Lock Period:** A text field containing the value '5', with a range 'Minute(s) (0-90), 0 : Not limit' to its right.
- Remote Privilege:** Three radio buttons labeled 'LAN', 'WAN', and 'LAN/WAN'. The 'LAN' option is selected.

At the bottom of the screen, there are two buttons: 'Cancel' on the left and 'OK' on the right.

Figure 198 Maintenance &gt; User Account &gt; Add

The following table describes the labels in this screen.

Table 124 Maintenance &gt; User Account &gt; User Account Add/Edit

LABEL	DESCRIPTION
Active	Click to enable (switch turns blue) or disable (switch turns gray) to activate or deactivate the user account.
User Name	Enter a name for this account. You can use up to 31 printable characters except [ " ], [ ` ], [ ' ], [ < ], [ > ], [ ^ ], [ \$ ], [   ], [ & ], or [ ; ]. Spaces are allowed.
Password	Enter your new system password. The password must contain at least one numeric and one alphabetic character. You can use 6 – 64 alphanumeric (0-9, a-z, A-Z) and special characters except [ " ], [ ` ], [ ' ], [ < ], [ > ], [ ^ ], [ \$ ], [   ], [ & ], or [ ; ]. Spaces are allowed.  Note that as you type a password, the screen displays a (*) for each character you type. After you change the password, use the new password to access the Zyxel Device.  If you are changing your existing password, you have to first enter your <b>Old Password</b> then enter your <b>New Password</b> .
Verify Password	Enter the new password again for confirmation.
Retry Times	Enter the number of times consecutive wrong passwords can be entered for this account. 0 means there is no limit.
Idle Timeout	Enter the length of inactive time before the Zyxel Device will automatically log the user out of the Web Configurator.
Lock Period	Enter the length of time a user must wait before attempting to log in again after a number of consecutive wrong passwords have been entered as defined in <b>Retry Times</b> .

Table 124 Maintenance &gt; User Account &gt; User Account Add/Edit (continued)

LABEL	DESCRIPTION
Group	<p>Specify whether this user will have <b>Administrator</b> or <b>User</b> privileges. An <b>Administrator</b> account can access all Web Configurator menus. A <b>User</b> account can only access <b>Monitor</b> and <b>Maintenance</b> menus.</p> <p>The maximum account number of <b>Administrator</b> and <b>User</b> are both four. The total number of the users allowed to log in the Zyxel Device at the same time is eight.</p> <p><b>The Administrator</b> privileges are the following:</p> <p><b>Quick Start</b> setup.</p> <p>The following screens are visible for setup:  <b>Broadband, Wireless, Home Networking, Routing, NAT, DNS, Firewall, MAC Filter, Voice, Log, Traffic Status, ARP Table, Routing Table, Cellular WAN Status, System, User Account, Remote Management, TR-069 Client, Time, Email Notification, Log Setting, Firmware Upgrade, Backup/Restore, Reboot, Diagnostic.</b></p> <p><b>The User</b> privileges are the following:</p> <p>The following screens are visible for setup:  <b>Log, Traffic Status, ARP Table, Routing Table, Cellular WAN Status, User Account, Remote Management, Time, Email Notification, Log Setting, Firmware Upgrade, Backup/Restore, Reboot, Diagnostic.</b></p>
Cancel	Click <b>Cancel</b> to restore your previously saved settings.
OK	Click <b>OK</b> to save your changes.

# CHAPTER 29

## Remote Management

### 29.1 Remote Management Overview

Remote management controls through which interfaces, which web services (such as HTTPS, SSH, SNMP, and Ping) can access the Zyxel Device.

Note: The Zyxel Device is managed using the Web Configurator.

#### 29.1.1 What You Can Do in this Chapter

- Use the **MGMT Services** screen to allow various approaches to access the Zyxel Device remotely from a WAN and/or LAN connection ([Section 29.2 on page 319](#)).
- Use the **Trust Domain** screen to enable users to permit access from local management services by entering specific IP addresses ([Section 29.3 on page 321](#)).
- Use **MGMT Services for IP Passthrough** to configure which interfaces you can use to access the Zyxel Device for a given service ([Section 29.4 on page 322](#)).
- Use **Trust Domain for IP Passthrough** to view a list of public IP addresses and complete domain names which are allowed to access the Zyxel Device ([Section 29.5 on page 323](#)).

### 29.2 MGMT Services

Note: The **MGMT Services** screen will be hidden if you enable the **IP Passthrough** function in **Network Setting > Broadband > Cellular IP Passthrough** screen.

Use this screen to configure the interfaces through which services can access the Zyxel Device. You can also specify service port numbers computers must use to connect to the Zyxel Device. Click **Maintenance > Remote Management > MGMT Services** to open the following screen.

**Figure 199** Maintenance > Remote Management > MGMT Services

Remote MGMT enables various approaches to access this device remotely from a WAN and/or LAN connection.

**Service Control**

WAN Interface used for services  Any\_WAN  Multi\_WAN

Cellular WAN 1  Cellular WAN 2  ETHWAN

Service	LAN/WLAN	WAN	Trust Domain	Port
HTTP	<input checked="" type="checkbox"/> Enable	<input type="checkbox"/> Enable	<input type="checkbox"/> Enable	80
HTTPS	<input checked="" type="checkbox"/> Enable	<input type="checkbox"/> Enable	<input type="checkbox"/> Enable	443
TELNET	<input type="checkbox"/> Enable	<input type="checkbox"/> Enable	<input type="checkbox"/> Enable	23
SSH	<input checked="" type="checkbox"/> Enable	<input type="checkbox"/> Enable	<input type="checkbox"/> Enable	22
PING	<input checked="" type="checkbox"/> Enable	<input type="checkbox"/> Enable	<input type="checkbox"/> Enable	

Cancel **Apply**

The following table describes the fields in this screen.

**Table 125** Maintenance > Remote Management > MGMT Services

LABEL	DESCRIPTION
Service Control	
WAN Interface used for services	Select <b>Any_WAN</b> to have the Zyxel Device automatically activate the remote management service when any WAN connection is up.  Select <b>Multi_WAN</b> and then select one or more WAN connections to have the Zyxel Device activate the remote management service when the selected WAN connections are up.
Cellular WAN	Enable the cellular WAN connection configured in <b>Network Setting &gt; Broadband &gt; Cellular WAN</b> to access the service on the Zyxel Device.  If there are multiple cellular WANs configured on the Zyxel Device, you can select which to use for the Zyxel Device management.
ETHWAN	Enable the Ethernet WAN connection configured in <b>Network Setting &gt; Broadband &gt; Ethernet WAN</b> to access the service on the Zyxel Device.
GPON	Enable the Gigabit Ethernet Passive Optical Network WAN connection configured in <b>Network Setting &gt; Broadband &gt; Add New WAN Interface</b> or <b>Modify</b> to access the service on the Zyxel Device.
Service	This is the service you may use to access the Zyxel Device.
LAN/WLAN	Select the <b>Enable</b> check box for the corresponding services that you want to allow access to the Zyxel Device from the LAN or WLAN.
WAN	Select the <b>Enable</b> checkbox for the corresponding services that you want to allow access to the Zyxel Device from all WAN connections.
Trust Domain	Select the <b>Enable</b> checkbox for the corresponding services that you want to allow access to the Zyxel Device from the trusted host IP address.
Port	You may change the server port number for a service if needed, however you must use the same port number in order to use that service for remote management.
Redirect	To allow only secure Web Configurator access, select this to redirect all HTTP connection requests to the HTTPS server. For example, if you enter http://192.168.1.1 in your browser to access the Web Configurator, then the Zyxel Device will automatically change this to the more secure https://192.168.1.1 for access.



Table 125 Maintenance &gt; Remote Management &gt; MGMT Services (continued)

LABEL	DESCRIPTION
Apply	Click <b>Apply</b> to save your changes back to the Zyxel Device.
Cancel	Click <b>Cancel</b> to restore your previously saved settings.

## 29.3 Trust Domain

Use this screen to view a list of public IP addresses which are allowed to access the Zyxel Device through the services configured in the **Maintenance > Remote Management > MGMT Services** screen. Click **Maintenance > Remote Management > Trust Domain** to open the following screen.

Note: Enter the IP address of the management station permitted to access the local management services. If specific services from the trusted hosts are allowed access but the trust domain list is empty, all public IP addresses can access the Zyxel Device from the WAN using the specified services.

Figure 200 Maintenance &gt; Remote Management &gt; Trust Domain

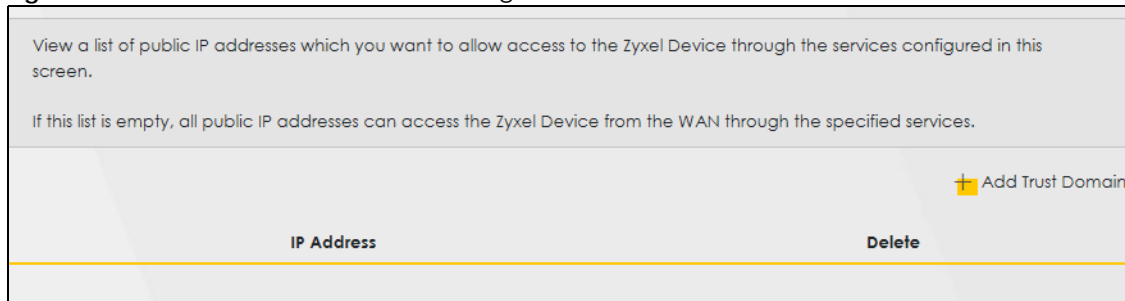

The following table describes the fields in this screen.

Table 126 Maintenance &gt; Remote Management &gt; Trust Domain

LABEL	DESCRIPTION
Add Trust Domain	Click this to add a trusted host IP address.
IP Address	This field shows a trusted host IP address.
Delete	Click the <b>Delete</b> icon to remove the trusted host IP address.

### 29.3.1 Add Trust Domain

Use this screen to add a public IP addresses or a complete domain name of a device which is allowed to access the Zyxel Device. Enter the IP address of the management station permitted to access the local management services. If specific services from the trusted-hosts are allowed access but the trust domain list is empty, all public IP addresses can access the Zyxel Device from the WAN using the specified services.

Click the **Add Trust Domain** button in the **Maintenance > Remote Management > Trust Domain** screen to open the following screen.

**Figure 201** Maintenance > Remote Management > Trust Domain > Add Trust Domain

The following table describes the fields in this screen.

**Table 127** Maintenance > Remote Management > Trust Domain > Add Trust Domain

LABEL	DESCRIPTION
IP Address	Enter a public IPv4/IPv6 IP address which is allowed to access the service on the Zyxel Device from the WAN.
OK	Click <b>OK</b> to save your changes back to the Zyxel Device.
Cancel	Click <b>Cancel</b> to restore your previously saved settings.

## 29.4 MGMT Services for IP Passthrough

Configure which interfaces you can use to access the Zyxel Device when **IP Passthrough** is enabled for a given service. You can also specify the service port numbers computers must use to connect to the Zyxel Device. IP Passthrough allows Internet traffic to go to a LAN computer behind the Zyxel Device without going through NAT. Make sure to enable IP Passthrough in **Network Setting > Broadband > Cellular IP Passthrough**.

Click **Maintenance > Remote Management > MGMT Services for IP Passthrough** to open the following screen.

**Figure 202** Maintenance > Remote Management > MGMT Services for IP Passthrough

Service	WAN	Trust Domain	Port
PT_HTTP	<input checked="" type="checkbox"/> Enable	<input type="checkbox"/> Enable	20080
PT_HTTPS	<input checked="" type="checkbox"/> Enable	<input type="checkbox"/> Enable	20443
PT_TELNET	<input type="checkbox"/> Enable	<input type="checkbox"/> Enable	20023
PT_SSH	<input type="checkbox"/> Enable	<input type="checkbox"/> Enable	20022

The following table describes the fields in this screen.

Table 128 Maintenance > Remote Management

LABEL	DESCRIPTION
Service	This is the service you may use to access the Zyxel Device.
WAN	Select the <b>Enable</b> check box for the corresponding services that you want to allow access to the Zyxel Device from all WAN connections.
Trust Domain	Select the <b>Enable</b> check box for the corresponding services that you want to allow access to the Zyxel Device from the trusted host IP address.
Port	You may change the server port number for a service if needed, however you must use the same port number in order to use that service for remote management.
Apply	Click <b>Apply</b> to save your changes back to the Zyxel Device.
Cancel	Click <b>Cancel</b> to restore your previously saved settings.

## 29.5 Trust Domain for IP Passthrough

Use this screen to view a list of public IP addresses/complete domain names which are allowed to access the Zyxel Device when **IP Passthrough** is enabled. IP Passthrough allows Internet traffic to go to a LAN computer behind the Zyxel Device without going through NAT. Make sure to enable IP Passthrough in **Network Setting > Broadband > Cellular IP Passthrough**.

Click **Maintenance > Remote Management > Trust Domain for IP Passthrough** to open the following screen.

Figure 203 Maintenance > Remote Management > Trust Domain for IP Passthrough

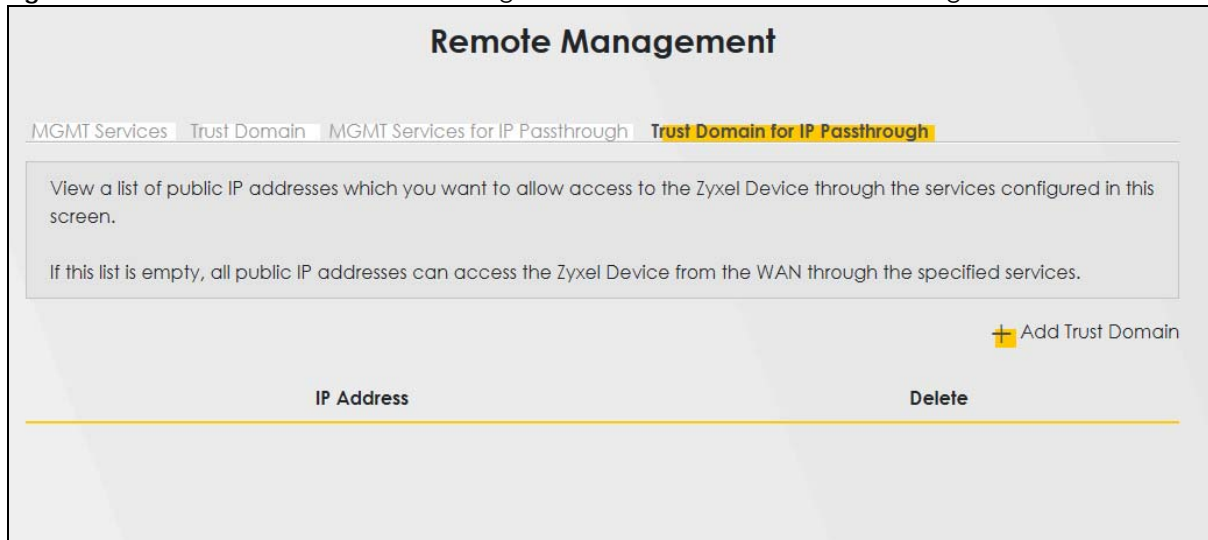

The following table describes the fields in this screen.

Table 129 Maintenance > Remote Management > Trust Domain for IP Passthrough

LABEL	DESCRIPTION
Add Trust Domain	Click this to add a trusted host IP address.
IP Address	This field shows a trusted host IP address.
Delete	Click the <b>Delete</b> icon to remove the trusted host IP address.

## 29.5.1 Add Trust Domain

Use this screen to add a public IP address or a complete domain name of a device which is allowed to access the Zyxel Device. Click the **Add Trust Domain** button in the **Maintenance > Remote Management > Trust Domain for IP Passthrough** screen to open the following screen.

**Figure 204** Maintenance > Remote Management > Trust Domain for IP Passthrough > Add Trust Domain

The following table describes the fields in this screen.

**Table 130** Maintenance > Remote Management > Trust Domain for IP Passthrough > Add Trust Domain

LABEL	DESCRIPTION
IP Address	Enter a public IPv4/IPv6 IP address which is allowed to access the service on the from the WAN.
Cancel	Click <b>Cancel</b> to restore your previously saved settings.
OK	Click <b>OK</b> to save your changes.

# CHAPTER 30

## TR-069 Client

### 30.1 TR-069 Overview

This chapter explains how to configure the Zyxel Device's TR-069 auto-configuration settings.

#### 30.1.1 TR-069 Client

TR-069 is a protocol that defines how your Zyxel Device can be managed via a management server. TR-069 is based on sending Remote Procedure Calls (RPCs) between an (Auto-Configuration Server) ACS and a client device. RPCs are sent in Extensible Markup Language (XML) format over HTTP or HTTPS. You can use a management server to remotely set up the Zyxel Device, modify settings, perform firmware upgrades as well as monitor and diagnose the Zyxel Device.

#### 30.1.2 XMPP

If a remotely-managed Zyxel Device is behind a NAT router and has a private IP address, then the ACS cannot communicate directly with the Zyxel Device. In this case, the Zyxel Device needs to communicate with the ACS through an XMPP server.

Figure 205 XMPP Connection Request



Click **Maintenance > TR-069 Client** to open the following screen.

**Figure 206** Maintenance > TR-069 Client

Allow your Zyxel Device to be managed remotely by an Auto Configuration Server (ACS) using TR-069.

CWMP Active

Inform

Inform Interval

IP Protocol  TR069 on IPv4 Only  TR069 on IPv6 Only  Auto Select

ACS URL  (URL or IPv4 Address / Global IPv6 Address)

ACS User Name

ACS Password

WAN Interface Used by TR-069 Client  Any\_WAN  Multi\_WAN

Cellular WAN 1  Cellular WAN 2

Display SOAP Messages on Serial Console

Connection Request Authentication

Connection Request User Name

Connection Request Password

Connection Request URL

Supplementary Client

Supplementary ACS URL  (URL or IPv4 Address / Global IPv6 Address)

Supplementary ACS User Name

Supplementary ACS Password

Validate ACS certificate

Local Certificate Used by TR-069 Client

[Cancel](#) [Apply](#)

The following table describes the fields in this screen.

**Table 131** Maintenance > TR-069 Client

LABEL	DESCRIPTION
CWMP Active	CPE WAN Management Protocol (CWMP) enables the Zyxel Device to be remotely configured through a WAN link. Communication between the Zyxel Device and the management server is conducted through SOAP/HTTP(S) in the form of remote procedure calls (RPC).  Click to enable (switch turns blue) to allow the Zyxel Device to be managed by a management server. Otherwise, click to disable (switch turns gray) to disallow the Zyxel Device to be managed by a management server.
Inform	Click to enable (switch turns blue) the Zyxel Device to send periodic inform through TR-069 on the WAN. Otherwise, click to disable (switch turns gray).
Inform Interval	Enter the time interval (in seconds) at which the Zyxel Device sends information to the auto-configuration server.
IP Protocol	Select the type of IP protocol to allow TR-069 to operate on.
ACS URL	Enter the URL or IP address of the auto-configuration server.

Table 131 Maintenance &gt; TR-069 Client (continued)

LABEL	DESCRIPTION
ACS User Name	Enter the TR-069 user name for authentication with the auto-configuration server.
ACS Password	Enter the TR-069 password for authentication with the auto-configuration server.
WAN Interface Used by TR-069 Client	<p>Select a WAN interface through which the TR-069 traffic passes.</p> <p>If you select <b>Any_WAN</b>, the Zyxel Device automatically passes the TR-069 traffic when any WAN connection is up.</p> <p>If you select <b>Multi_WAN</b>, you also need to select two or more pre-configured WAN interfaces. The Zyxel Device automatically passes the TR-069 traffic when one of the selected WAN connections is up.</p>
Cellular WAN / WWAN / ETHWAN	The Zyxel Device automatically passes the TR-069 traffic when cellular / 4G/5G/6G mobile / Ethernet WAN connection is up.
Display SOAP Messages on Serial Console	Click to enable (switch turns blue) the dumping of all SOAP messages during the ACS server communication with the CPE.
Connection Request Authentication	Select this option to enable authentication when there is a connection request from the ACS.
Connection Request User Name	<p>Enter the connection request user name.</p> <p>When the ACS makes a connection request to the Zyxel Device, this user name is used to authenticate the ACS.</p>
Connection Request Password	<p>Enter the connection request password.</p> <p>When the ACS makes a connection request to the Zyxel Device, this password is used to authenticate the ACS.</p>
Connection Request URL	<p>This shows the connection request URL.</p> <p>The ACS can use this URL to make a connection request to the Zyxel Device.</p>
Supplementary ACS URL	Enter the URL or IP address of an additional TR-069 auto-configuration server.
Supplementary ACS User Name	Enter the user name of an additional TR-069 auto-configuration server for authentication.
Supplementary ACS Password	Enter the password of an additional TR-069 auto-configuration server for authentication.
Validate ACS Certificate	Click to enable (switch turns blue) the validation of a local certificate used by TR-069 client.
Local Certificate Used by TR-069 Client	You can choose a local certificate used by TR-069 client. The local certificate should be imported in the <b>Security &gt; Certificates &gt; Local Certificates</b> screen.
Apply	Click <b>Apply</b> to save your changes.
Cancel	Click <b>Cancel</b> to restore the screen's last saved settings.

# CHAPTER 31

## Time Settings

### 31.1 Time Settings Overview

This chapter shows you how to configure system related settings, such as system date and time.

### 31.2 Time

For effective scheduling and logging, the Zyxel Device system time must be accurate. Use this screen to configure the Zyxel Device's time based on your local time zone. You can enter a time server address, select the time zone where the Zyxel Device is physically located, and configure Daylight Savings settings if needed.

To change your Zyxel Device's time and date, click **Maintenance** > **Time**. The screen appears as shown.



Figure 207 Maintenance &gt; Time

Configure the Zyxel Device's time based on your local time zone. You can add a time server address, select your time zone, and configure Daylight Savings if your location uses it.

**Current Date/Time**

Current Time 14:21:53  
Current Date 2019-02-27

**Time and Date Setup**

Time Protocol SNTP (RFC-1769)

First Time Server Address pool.ntp.org

Second Time Server Address clock.nyc.he.net

Third Time Server Address clock.sjc.he.net

Fourth Time Server Address None

Fifth Time Server Address None

**Time Zone**

Time Zone (GMT+08:00) Taipei

**Daylight Savings**

Active

**Start Rule**

Day  1 in  
 Last Sunday in

Month March

Hour 2 0

**End Rule**

Day  1 in  
 Last Sunday in

Month October

Hour 3 0

Cancel **Apply**

The following table describes the fields in this screen.

Table 132 Maintenance &gt; Time

LABEL	DESCRIPTION
Current Date/Time	
Current Time	This displays the time of your Zyxel Device. Each time you reload this screen, the Zyxel Device synchronizes the time with the time server.
Current Date	This displays the date of your Zyxel Device. Each time you reload this screen, the Zyxel Device synchronizes the date with the time server.
Time and Date Setup	
Time Protocol	This displays the time protocol used by your Zyxel Device.

Table 132 Maintenance &gt; Time (continued)

LABEL	DESCRIPTION
First – Fifth Time Server Address	<p>Select an NTP time server from the drop-down list box.</p> <p>Otherwise, select <b>Other</b> and enter the IP address or URL (up to 29 printable characters in length) of your time server.</p> <p>Select <b>None</b> if you do not want to configure the time server.</p> <p>Check with your ISP/network administrator if you are unsure of this information.</p>
Time Zone	
Time zone	Choose the time zone of your location. This will set the time difference between your time zone and Greenwich Mean Time (GMT).
<p>Daylight Savings</p> <p>Daylight Saving Time is a period from late spring to early fall when many countries set their clocks ahead of normal local time by one hour to give more daytime light in the evening.</p>	
Active	Click this switch to enable or disable Daylight Saving Time. When the switch turns blue, the function is enabled. Otherwise, it is not.
Start Rule	<p>Configure the day and time when Daylight Saving Time starts if you enabled Daylight Saving. You can select a specific date in a particular month or a specific day of a specific week in a particular month. The <b>Time</b> field uses the 24 hour format. Here are a couple of examples:</p> <p>Daylight Saving Time starts in most parts of the United States on the second Sunday of March. Each time zone in the United States starts using Daylight Saving Time at 2 A.M. local time. So in the United States, set the day to <b>Second, Sunday</b>, the month to <b>March</b> and the time to <b>2</b> in the <b>Hour</b> field.</p> <p>Daylight Saving Time starts in the European Union on the last Sunday of March. All of the time zones in the European Union start using Daylight Saving Time at the same moment (1 A.M. GMT or UTC). So in the European Union you would set the day to <b>Last, Sunday</b> and the month to <b>March</b>. The time you select in the <b>o'clock</b> field depends on your time zone. In Germany for instance, you would select <b>2</b> in the <b>Hour</b> field because Germany's time zone is one hour ahead of GMT or UTC (GMT+1).</p>
End Rule	<p>Configure the day and time when Daylight Saving Time ends if you enabled Daylight Saving. You can select a specific date in a particular month or a specific day of a specific week in a particular month. The <b>Time</b> field uses the 24 hour format. Here are a couple of examples:</p> <p>Daylight Saving Time ends in the United States on the first Sunday of November. Each time zone in the United States stops using Daylight Saving Time at 2 A.M. local time. So in the United States you would set the day to <b>First, Sunday</b>, the month to <b>November</b> and the time to <b>2</b> in the <b>Hour</b> field.</p> <p>Daylight Saving Time ends in the European Union on the last Sunday of October. All of the time zones in the European Union stop using Daylight Saving Time at the same moment (1 A.M. GMT or UTC). So in the European Union you would set the day to <b>Last, Sunday</b>, and the month to <b>October</b>. The time you select in the <b>o'clock</b> field depends on your time zone. In Germany for instance, you would select <b>2</b> in the <b>Hour</b> field because Germany's time zone is one hour ahead of GMT or UTC (GMT+1).</p>
Cancel	Click <b>Cancel</b> to exit this screen without saving.
Apply	Click <b>Apply</b> to save your changes.

# CHAPTER 32

## Email Notification

### 32.1 Email Notification Overview

A mail server is an application or a computer that can receive, forward and deliver email messages.

To have the Zyxel Device send reports, logs or notifications through email, you must specify an email server and the email addresses of the sender and receiver.

### 32.2 Email Notification

Use this screen to view, remove and add email account information on the Zyxel Device. This account can be set to send email notifications for logs.

Click **Maintenance > E-mail Notification** to open the **E-mail Notification** screen.

Note: The default port number of the mail server is 25.

**Figure 208** Maintenance > E-mail Notification

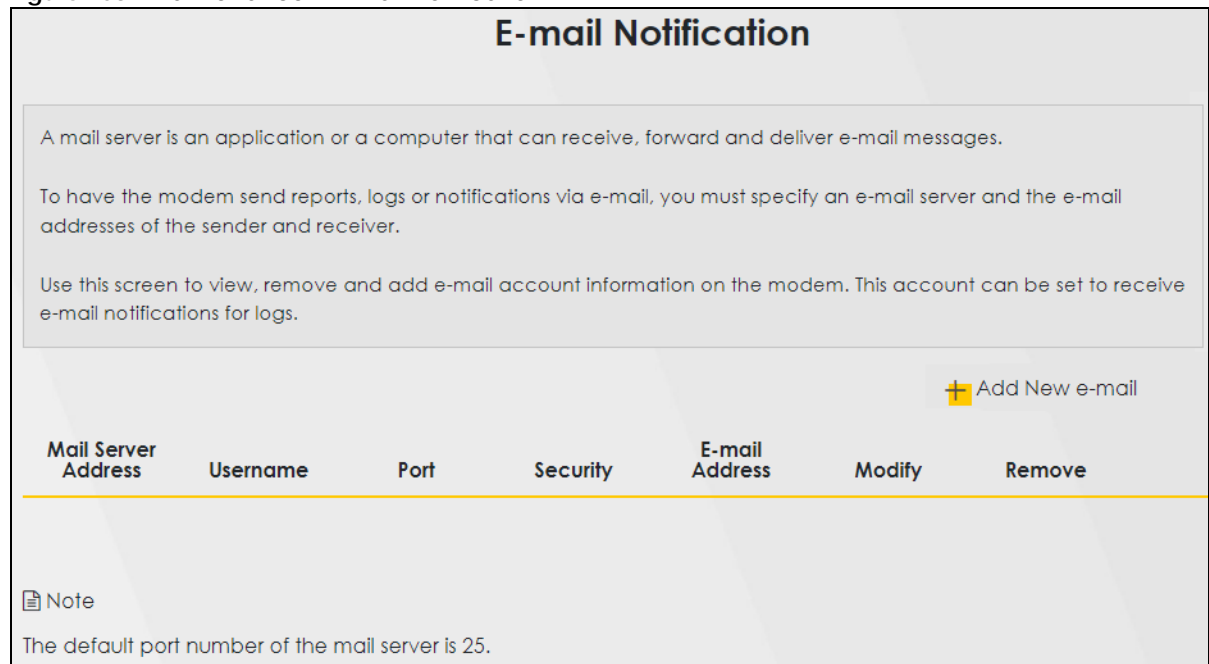

**E-mail Notification**

A mail server is an application or a computer that can receive, forward and deliver e-mail messages.

To have the modem send reports, logs or notifications via e-mail, you must specify an e-mail server and the e-mail addresses of the sender and receiver.

Use this screen to view, remove and add e-mail account information on the modem. This account can be set to receive e-mail notifications for logs.

 Add New e-mail

Mail Server Address	Username	Port	Security	E-mail Address	Modify	Remove
---------------------	----------	------	----------	----------------	--------	--------

 Note  
The default port number of the mail server is 25.

The following table describes the labels in this screen.

Table 133 Maintenance > E-mail Notification

LABEL	DESCRIPTION
Add New e-mail	Click this button to create a new entry (up to 32 can be created).
Mail Server Address	This displays the server name or the IP address of the mail server.
Username	This displays the user name of the sender's mail account.
Port	This field displays the port number of the mail server.
Security	This field displays the protocol used for encryption.
E-mail Address	This field displays the email address that you want to be in the from or sender line of the email that the Zyxel Device sends.
Modify	Click the <b>Edit</b> icon to configure the entry. Click the <b>Delete</b> icon to remove the entry.
Remove	Click this button to delete the selected entries.

### 32.2.1 E-mail Notification Edit

Click the **Add** button in the **E-mail Notification** screen. Use this screen to configure the required information for sending email through a mail server.

Figure 209 Maintenance > E-mail Notification > Add

The screenshot shows the 'Add New e-mail' configuration screen. At the top, there is a back arrow and the title 'Add New e-mail'. Below the title is the section 'E-mail Notification Configuration'. The configuration fields are as follows:

- Mail Server Address:** A text input field with a placeholder '(SMTP Server NAME or IP)' to its right.
- Port:** A text input field containing the value '25', with a placeholder 'Default:25' to its right.
- Authentication Username:** A text input field.
- Authentication Password:** A text input field with a visibility toggle icon (an eye) to its right.
- Account e-mail Address:** A text input field.
- Connection Security:** Two radio buttons: 'SSL' (unselected) and 'STARTTLS' (selected).

At the bottom of the screen, there are two buttons: 'Cancel' and 'OK'.

The following table describes the labels in this screen.

Table 134 Maintenance > E-mail Notification > Add

LABEL	DESCRIPTION
Mail Server Address	Enter the server name or the IP address of the mail server for the email address specified in the <b>Account e-mail Address</b> field.  If this field is left blank, reports, logs or notifications will not be sent through email.
Port	Enter the same port number here as is on the mail server for mail traffic.
Authentication Username	Enter the user name. You can use up to 32 printable characters except [ " ], [ ` ], [ ' ], [ < ], [ > ], [ ^ ], [ \$ ], [   ], [ & ], or [ ; ]. Spaces are allowed. This is usually the user name of a mail account you specified in the <b>Account email Address</b> field.
Authentication Password	Enter the password associated with the user name above.
Account e-mail Address	Enter the email address that you want to be in the from or sender line of the email notification that the Zyxel Device sends.  If you activate SSL/TLS authentication, the email address must be able to be authenticated by the mail server as well.
Connection Security	Select <b>SSL</b> to use Secure Sockets Layer (SSL) or Transport Layer Security (TLS) if you want encrypted communications between the mail server and the Zyxel Device.  Select <b>STARTTLS</b> to upgrade a plain text connection to a secure connection using SSL/TLS.
Cancel	Click this button to begin configuring this screen afresh.
OK	Click this button to save your changes and return to the previous screen.

# CHAPTER 33

## Log Setting

### 33.1 Log Setting Overview

You can configure where the Zyxel Device sends logs and which type of logs the Zyxel Device records in the **Logs Setting** screen.

### 33.2 Log Setting

Use this screen to configure where the Zyxel Device sends logs, and which type of logs the Zyxel Device records.

If you have a server that is running a syslog service, you can also save log files to it by enabling **Syslog Logging**, and then entering the IP address of the server in the **Syslog Server** field. Select **Remote** to store logs on the syslog server, or select **Local File** to store logs on the Zyxel Device. Select **Local File and Remote** to store logs on both the Zyxel Device and the syslog server. To change your Zyxel Device's log settings, click **Maintenance > Log Setting**. The screen appears as shown.

Figure 210 Maintenance > Log Setting

You can configure where the Zyxel Device sends logs and which logs and/or immediate alerts the Zyxel Device records.

If there is a LAN client on your network or a remote server that is running a syslog utility, you can save log files from LAN computers to it by enabling **Syslog Logging**, selecting **Remote** or **Local File and Remote** in the **Mode** field, and entering the IP address of the syslog server in the **Syslog Server** field. **Remote** allows you to store logs on a syslog server, while **Local File** allows you to store them on the Zyxel Device. **Local File and Remote** means your logs are stored both on the Zyxel Device and on a syslog server.

**Syslog Setting**

Syslog Logging

Mode

Syslog Server  (Server NAME or IPv4/IPv6 Address)

UDP Port  (Server Port)

**E-mail Log Settings**

E-mail Log Settings

Mail Account

System Log Mail Subject

Security Log Mail Subject

Send Log to  (E-Mail Address)

Send Alarm to  (E-Mail Address)

Alarm Interval  (seconds)

**Active Log**

**System Log**

- WAN-DHCP
- DHCP Server
- TR-069
- HTTP
- UPNP
- System
- ACL
- Wireless
- Cellular WAN
- SAS CBSD

**Security Log**

- Account
- Attack
- Firewall
- MAC Filter

Cancel

The following table describes the fields in this screen.

Table 135 Maintenance > Log Setting

LABEL	DESCRIPTION
Syslog Settings	
Syslog Logging	Slide the switch to the right to enable syslog logging.
Mode	<p>Select <b>Remote</b> to have the Zyxel Device send it to an external syslog server.</p> <p>Select <b>Local File</b> to have the Zyxel Device save the log file on the Zyxel Device itself.</p> <p>Select <b>Local File and Remote</b> to have the Zyxel Device save the log file on the Zyxel Device itself and send it to an external syslog server.</p> <p>Note: A warning appears upon selecting <b>Remote</b> or <b>Local File and Remote</b>. Just click <b>OK</b> to continue.</p>

Table 135 Maintenance &gt; Log Setting (continued)

LABEL	DESCRIPTION
Syslog Server	Enter the server name or IP address of the syslog server that will log the selected categories of logs.
UDP Port	Enter the port number used by the syslog server.
E-mail Log Settings	
E-mail Log Settings	Slide the switch to the right to allow the sending through email the system and security logs to the email address specified in <b>Send Log to</b> .  Note: Make sure that the <b>Mail Server Address</b> field is not left blank in the <b>Maintenance &gt; E-mail Notifications</b> screen.
Mail Account	Select a server specified in <b>Maintenance &gt; E-mail Notifications</b> to send the logs to.
System Log Mail Subject	This field allows you to enter a descriptive name for the system log email (for example Zyxel System Log). Up to 127 printable characters are allowed for the <b>System Log Mail Subject</b> including special characters inside the square brackets [!#%()*+,-./:=?@[{}~].
Security Log Mail Subject	This field allows you to enter a descriptive name for the security log email (for example Zyxel Security Log). Up to 127 printable characters are allowed for the <b>Security Log Mail Subject</b> including special characters inside the square brackets [!#%()*+,-./:=?@[{}~].
Send Log to	This field allows you to enter the log's designated email recipient. The log's format is plain text file sent as an email attachment.
Send Alarm to	This field allows you to enter the alarm's designated e-mail recipient. The alarm's format is plain text file sent as an email attachment.
Alarm Interval	Select the frequency of showing of the alarm.
Active Log	
System Log	Select the categories of <b>System Logs</b> that you want to record.
Security Log	Select the categories of <b>Security Logs</b> that you want to record.
Apply	Click <b>Apply</b> to save your changes.
Cancel	Click <b>Cancel</b> to restore your previously saved settings.

### 33.2.1 Example Email Log

An 'End of Log' message displays for each mail in which a complete log has been sent. The following is an example of a log sent by email.

- You may edit the subject title.
- The date format here is Day-Month-Year.
- The date format here is Month-Day-Year. The time format is Hour-Minute-Second.
- 'End of Log' message shows that a complete log has been sent.



Figure 211 Email Log Example

```

Subject:
    Firewall Alert From
Date:
    Fri, 07 Apr 2000 10:05:42
From:
    user@zyxel.com
To:
    user@zyxel.com
1|Apr 7 00 |From:192.168.1.1      To:192.168.1.255  |default policy |forward
  |09:54:03 |UDP      src port:00520 dest port:00520  |<1,00>         |
2|Apr 7 00  |From:192.168.1.131   To:192.168.1.255  |default policy |forward
  |09:54:17  |UDP      src port:00520 dest port:00520  |<1,00>         |
3|Apr 7 00  |From:192.168.1.6     To:10.10.10.10    |match          |forward
  |09:54:19  |UDP      src port:03516 dest port:00053  |<1,01>         |
.....{snip}.....
.....{snip}.....
126|Apr 7 00  |From:192.168.1.1     To:192.168.1.255  |match          |forward
   |10:05:00  |UDP      src port:00520 dest port:00520  |<1,02>         |
127|Apr 7 00  |From:192.168.1.131   To:192.168.1.255  |match          |forward
   |10:05:17  |UDP      src port:00520 dest port:00520  |<1,02>         |
128|Apr 7 00  |From:192.168.1.1     To:192.168.1.255  |match          |forward
   |10:05:30  |UDP      src port:00520 dest port:00520  |<1,02>         |

End of Firewall Log

```

# CHAPTER 34

## Firmware Upgrade

### 34.1 Firmware Upgrade Overview

This chapter explains how to upload new firmware to your Zyxel Device if you get new firmware releases from your service provider.

### 34.2 Firmware Upgrade

This screen lets you upload new firmware to your Zyxel Device.

Get the latest firmware from your service provider. Then upload the firmware file to your Zyxel Device. The upload process uses HTTP (Hypertext Transfer Protocol). The upload may take up to 3 minutes. After a successful upload, the Zyxel Device will reboot.

Click **Maintenance > Firmware Upgrade** to open the **following** screen.

**Do NOT turn off the Zyxel Device while firmware upload is in progress!**

**Figure 212** Maintenance > Firmware Upgrade

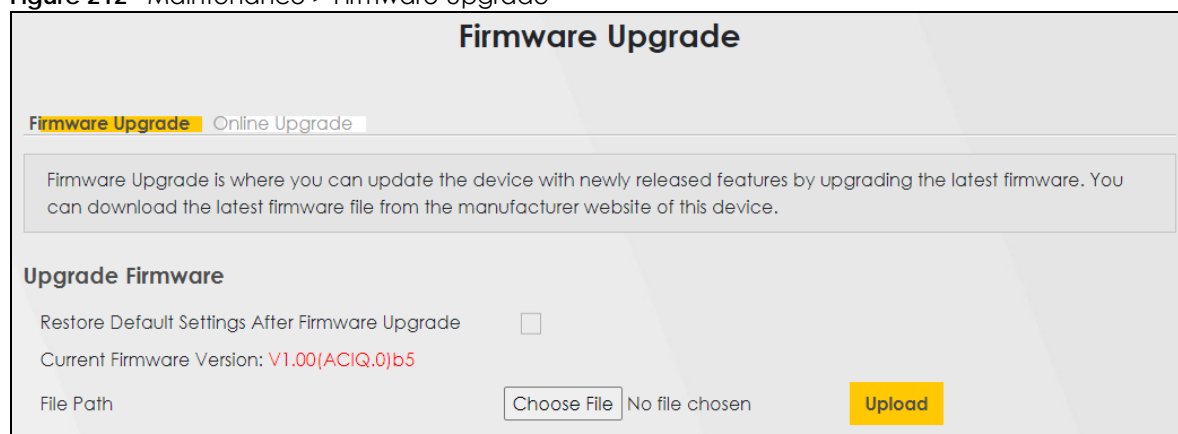

The screenshot shows a web interface titled "Firmware Upgrade". At the top, there are two tabs: "Firmware Upgrade" (which is highlighted in yellow) and "Online Upgrade". Below the tabs is a text box containing the following text: "Firmware Upgrade is where you can update the device with newly released features by upgrading the latest firmware. You can download the latest firmware file from the manufacturer website of this device." Below this text box is a section titled "Upgrade Firmware". In this section, there is a checkbox labeled "Restore Default Settings After Firmware Upgrade" which is currently unchecked. Below the checkbox, the text "Current Firmware Version: V1.00(ACIQ.0)b5" is displayed. At the bottom of the section, there is a "File Path" label, a "Choose File" button, the text "No file chosen", and a yellow "Upload" button.

The following table describes the labels in this screen.

Table 136 Maintenance > Firmware Upgrade

LABEL	DESCRIPTION
Upgrade Firmware	
Restore Default Settings After Firmware Upgrade	Select this to reset all your configurations, including Mesh WiFi settings, to the factory defaults after firmware upgrade. Otherwise, make sure this is cleared if you do not want the Zyxel Device to lose all its current configurations and return to the factory defaults.  Note: Make sure to back up the Zyxel Device's configuration settings first in case the reset all settings process is not successful.
Current Firmware Version	This is the current firmware version.
File Path	Enter the location of the file you want to upload in this field or click <b>Choose File/Browse</b> to find it.
Choose File/Browse	Click this to find the .bin file you want to upload. Remember that you must decompress compressed (.zip) files before you can upload them.
Upload	Click this to begin the upload process. This process may take up to 3 minutes.  Note: Only use firmware for your Zyxel Device's specific model. Refer to the label on the bottom of your Zyxel Device. For example, if the Zyxel Device's current firmware version is V5.70(ACDZ.0)B4, you must upload the firmware file containing "ACDZ".

After you see the firmware updating screen, wait a few minutes before logging into the Zyxel Device again.

Figure 213 Firmware Uploading

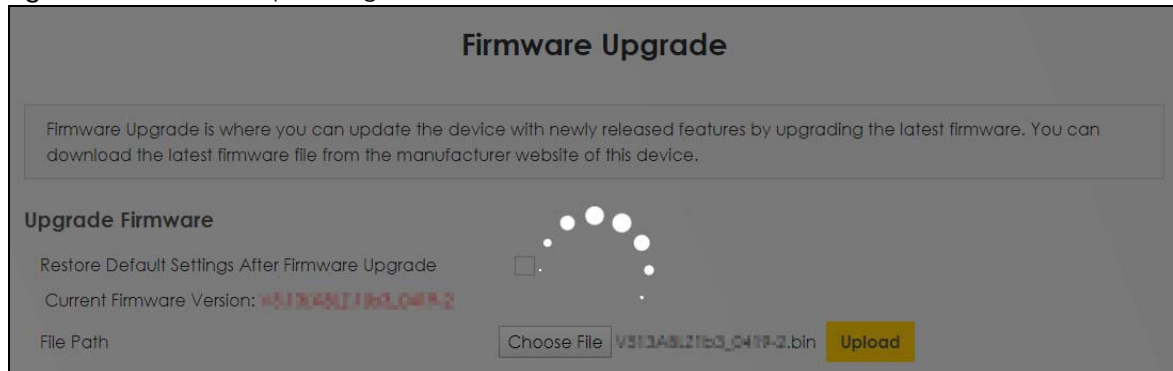

The Zyxel Device automatically restarts in this time causing a temporary network disconnect. In some operating systems, you may see the following icon on your desktop.

Figure 214 Network Temporarily Disconnected

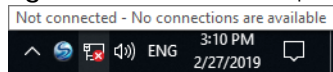

After 2 minutes, log in again and check your new firmware version in the **Connection Status** screen.

If the upload was not successful, an error screen will appear. Click **OK** to go back to the **Firmware Upgrade** screen.

Figure 215 Error Message

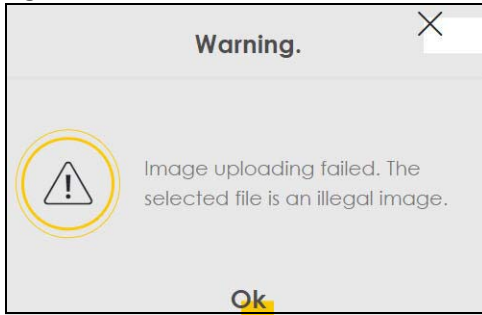

## 34.3 Online Upgrade

This screen lets you check for new firmware for your Zyxel Device by checking online for the latest firmware file now or scheduling when the Zyxel Device will check online for the latest firmware file.

Note: Make sure your Zyxel Device is connected to the Internet.

The upload process uses HTTP (Hypertext Transfer Protocol) and may take more than 3 minutes. After a successful upload, the Zyxel Device will reboot automatically.

Click **Maintenance > Firmware Upgrade > Online Upgrade** to open the following screen.

**Do NOT turn off the Zyxel Device while firmware upload is in progress!**

Figure 216 Maintenance &gt; Firmware Upgrade &gt; Online Upgrade

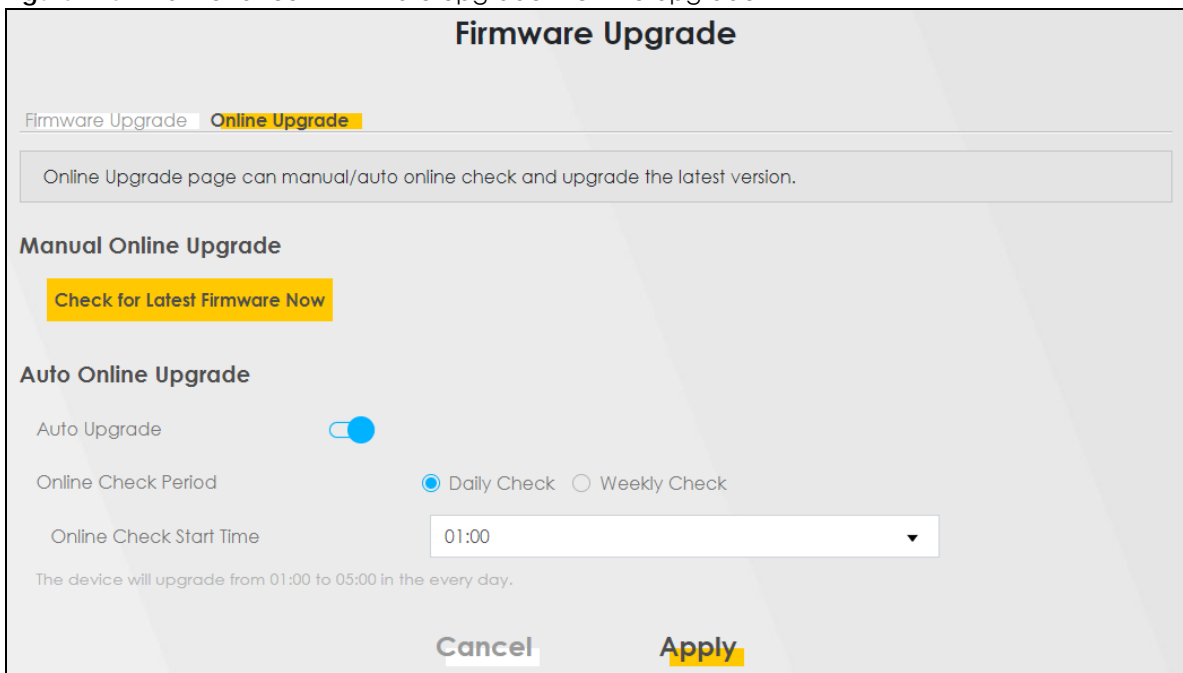

The following table describes the labels in this screen.

Table 137 Maintenance > Firmware Upgrade > Online Upgrade

LABEL	DESCRIPTION
Manual Online Upgrade	
Check for Latest Firmware Now	Click this to have the Zyxel Device check for new firmware immediately. If a newer firmware is available, follow the online prompt to upload the new firmware to your Zyxel Device.
Auto Online Upgrade	
Auto Upgrade	Click the switch to the right to activate automatic firmware upgrade.  Note: To minimize disruption to your network, the Zyxel Device will upgrade the firmware from 01:00 to 05:00 by default.
Online Check Period	Select <b>Daily Check</b> when you want the Zyxel Device to check online for new firmware everyday.  Select <b>Weekly Check</b> when you want the Zyxel Device to check online for new firmware once a week.
The day of every week	Select the day that you want the Zyxel Device to check for new firmware.  Note: This field only appears when you select <b>Weekly Check</b> in <b>Online Check Period</b> .
Online Check Start Time	Select the hour of the day that you want the Zyxel Device to check for new firmware.
Cancel	Click <b>Cancel</b> to close the window with changes unsaved.
Apply	Click <b>Apply</b> to save the changes back to the Zyxel Device.

# CHAPTER 35

# Backup/Restore

## 35.1 Backup/Restore Overview

Information related to factory default settings and backup configuration are shown in this screen. You can also use this to restore Zyxel Device's previous configurations.

## 35.2 Backup/Restore

Click **Maintenance > Backup/Restore**. Information related to factory defaults, backup configuration, and restoring configuration appears in this screen, as shown next.

Figure 217 Maintenance &gt; Backup/Restore

## Backup/Restore

Back up and restore your Zyxel Device configurations. You can also reset your Zyxel Device settings back to the factory default.

**Backup Configuration** allows you to back up (save) the Zyxel Device's current configuration to a file on your computer. Once the Zyxel Device is configured and functioning properly, it is highly recommended that you back up your configuration file before making configuration changes. The backup configuration file will be useful in case you need to return to your previous settings.

**Restore Configuration** allows you to upload a new or previously saved configuration file from your computer to your Zyxel Device.

### Backup Configuration

Click Backup to save the current configuration of your system to your computer.

**Backup**

### Restore Configuration

To restore a previously saved configuration file to your system, browse to the location of the configuration file and click Upload.

File Path  No file chosen **Upload**

### Back to Factory Default Settings

Click Reset to clear all user-entered configuration information and return to factory default settings. After resetting, the

- Password is printed on a label on the bottom of the device, written after the text "Password".
- LAN IP address will be 192.168.1.1
- DHCP will be reset to default setting

**Reset**

Figure 218 Maintenance &gt; Backup/Restore

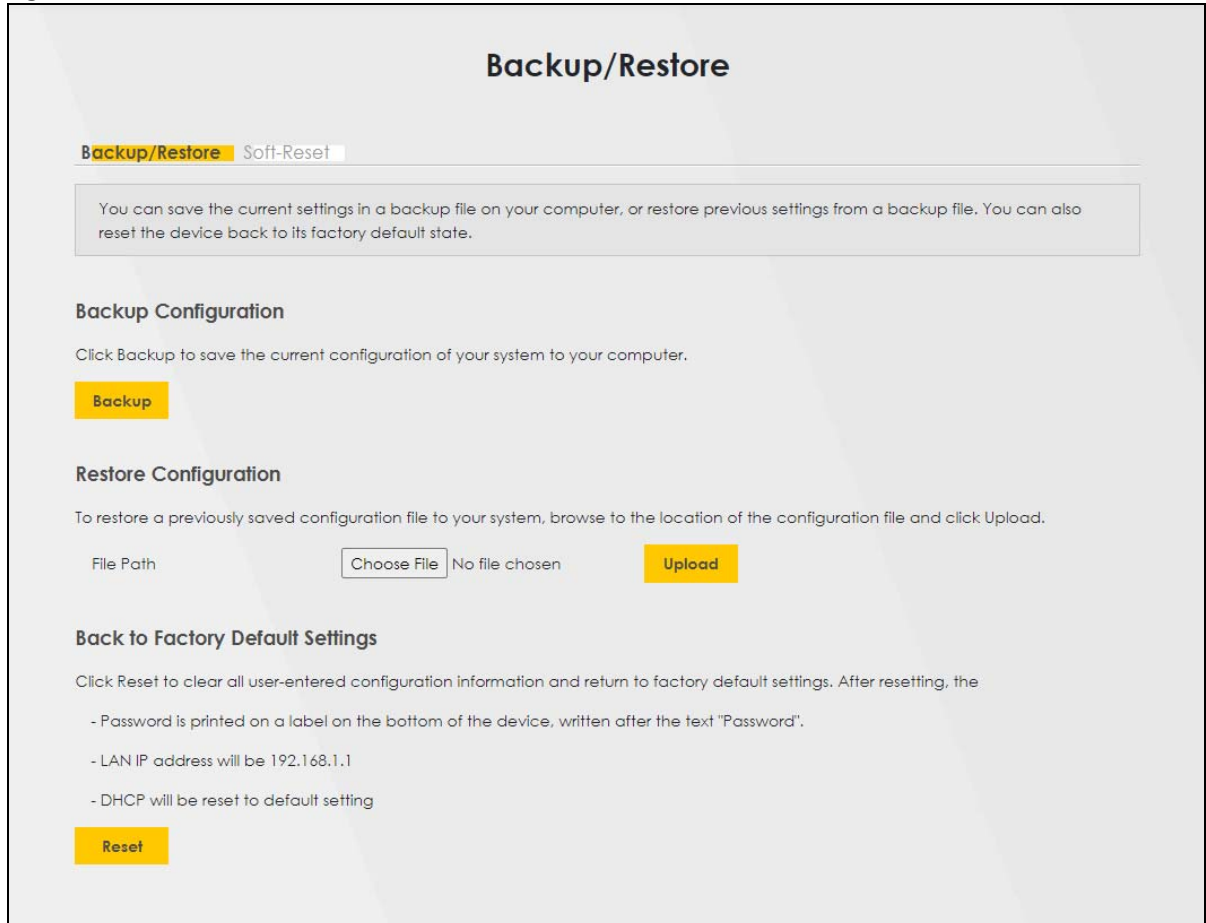

## Backup Configuration

**Backup Configuration** allows you to back up (save) the Zyxel Device's current configuration to a file on your computer. Once your Zyxel Device is configured and functioning properly, it is highly recommended that you back up your configuration file before making configuration changes. The backup configuration file will be useful in case you need to return to your previous settings.

Click **Backup** to save the Zyxel Device's current configuration to your computer.

## Restore Configuration

**Restore Configuration** allows you to upload a new or previously saved configuration file from your computer to your Zyxel Device.

Table 138 Maintenance &gt; Backup/Restore: Restore Configuration

LABEL	DESCRIPTION
File Path	Enter in the location of the file you want to upload in this field or click <b>Choose File / Browse</b> to find it.
Choose File / Browse	Click this to find the file you want to upload. Remember that you must decompress compressed (.ZIP) files before you can upload them.
Upload	Click this to begin the upload process.
Reset	Click this to reset your Zyxel Device settings back to the factory default.



## Do not turn off the Zyxel Device while configuration file upload is in progress.

After the Zyxel Device configuration has been restored successfully, the login screen appears. Login again to restart the Zyxel Device.

The Zyxel Device automatically restarts in this time causing a temporary network disconnect. In some operating systems, you may see the following icon on your desktop.

**Figure 219** Network Temporarily Disconnected

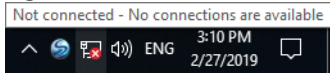

If you restore the default configuration, you may need to change the IP address of your computer to be in the same subnet as that of the default Zyxel Device IP address (192.168.1.1 – 192.168.225.225).

If the upload was not successful, an error screen will appear. Click **OK** to go back to the **Configuration** screen.

**Figure 220** Configuration Upload Error

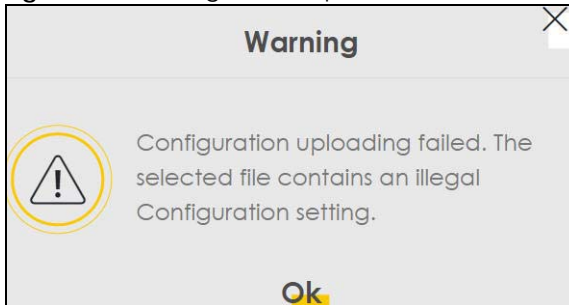

## Back to Factory Default Settings

Click the **Reset All Settings** button to clear all user-entered configuration information and return the Zyxel Device to its factory defaults. The following warning screen appears.

**Figure 221** Reset Warning Message

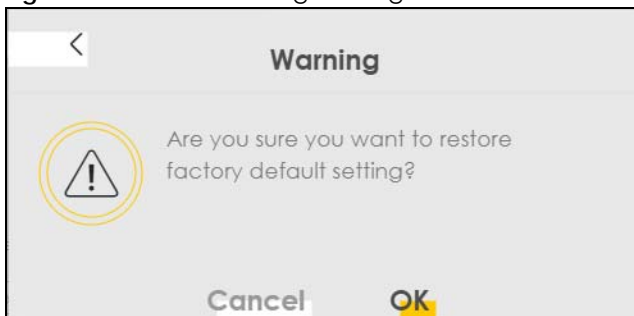
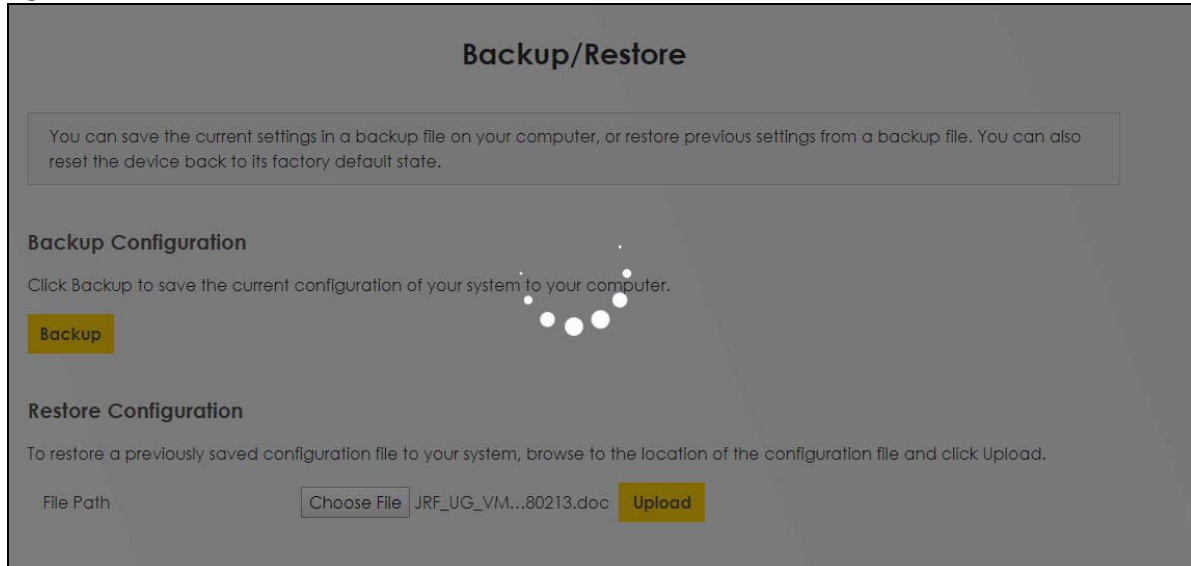

Figure 222 Reset In Progress



You can also press the **RESET** button on the panel to reset the Zyxel Device to the factory defaults.

## 35.3 Soft-Reset

**Soft-Reset** allows you to keep specific configurations after resetting the Zyxel Device to the factory default settings. This feature is available when you reset using the web configurator.

Note: NR5103E, NR5103EV2, and NR5103EV3 are the models that support soft-reset.

Click **Maintenance > Backup/Restore > Soft-Reset** to open the following screen.

Figure 223 Soft-Reset

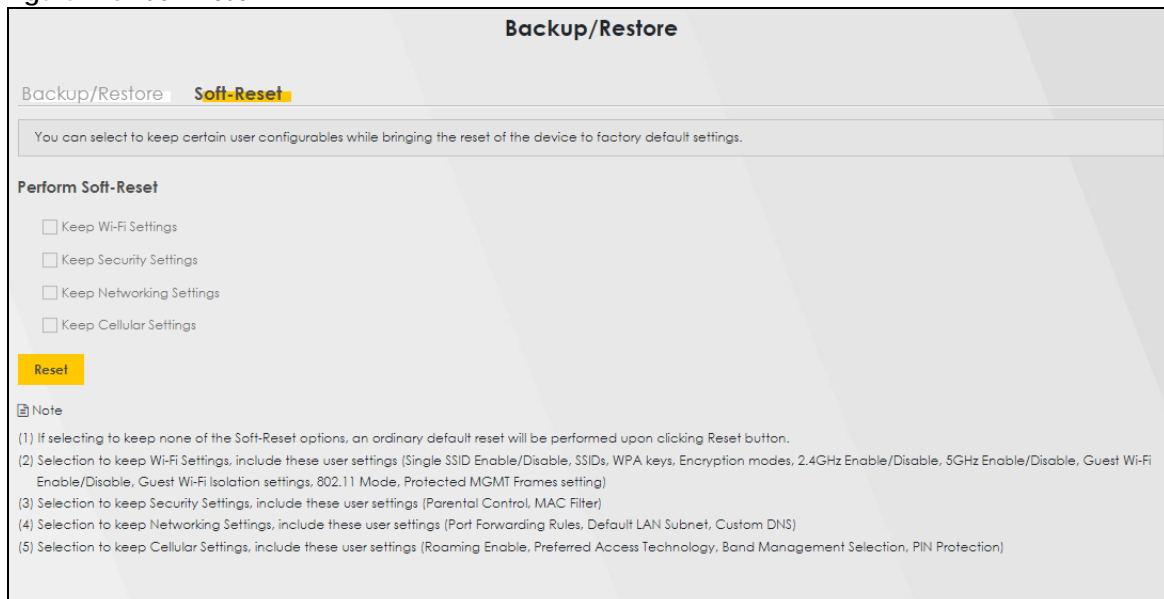

Table 139 Maintenance &gt; Backup/Restore &gt; Soft-Reset

LABEL	DESCRIPTION
Perform Soft-Reset	
Keep Wi-Fi Settings	Select this checkbox to maintain the following settings on the Zyxel Device: <ul style="list-style-type: none"> <li>• 2.4GHz &amp; 5GHz settings in <b>Network Setting &gt; Wireless &gt; General</b>.</li> <li>• SSID settings in <b>Network Setting &gt; Wireless &gt; General</b> and <b>Guest/ More AP</b>.</li> <li>• WPA keys in <b>Network Setting &gt; Wireless &gt; General</b>.</li> <li>• Encryption types (AES or TKIP+AES) in <b>Network Setting &gt; Wireless &gt; General</b>.</li> <li>• Guest Wi-Fi settings in <b>Network Setting &gt; Wireless &gt; Guest/ More AP</b>.</li> <li>• 802.11 Mode in <b>Network Setting &gt; Wireless &gt; Others</b>.</li> <li>• Protected Management Frames settings in <b>Network Setting &gt; Wireless &gt; Others</b>.</li> </ul> See <a href="#">Chapter 8 on page 141</a> for more details.
Keep Security Settings	Select this checkbox to maintain the following settings on the Zyxel Device: <ul style="list-style-type: none"> <li>• MAC filtering in <b>Security &gt; MAC Filter</b>. See <a href="#">Chapter 16 on page 245</a> for more details.</li> <li>• Parental control in <b>Security &gt; Parental Control</b>. See <a href="#">Chapter 17 on page 248</a> for more details.</li> </ul>
Keep Networking Settings	Select this checkbox to maintain the following settings on the Zyxel Device: <ul style="list-style-type: none"> <li>• The rules of port forwarding in <b>Network Setting &gt; NAT &gt; Port Forwarding</b>. See <a href="#">Section 12.2 on page 212</a> for more details.</li> <li>• The LAN IP setup in <b>Network Setting &gt; Home Networking &gt; LAN Setup</b>. See <a href="#">Section 9.2 on page 174</a> for more details.</li> <li>• The custom DNS in <b>Network Setting &gt; DNS</b>. See <a href="#">Chapter 13 on page 224</a> for more details.</li> </ul>
Keep Cellular Settings	Select this checkbox to maintain the following settings on the Zyxel Device: <ul style="list-style-type: none"> <li>• Roaming in <b>Network Setting &gt; Broadband &gt; Cellular WAN</b></li> <li>• The preferred cellular mode (4G, NR5G-NSA, or NR5G-SA) and band management in <b>Network Setting &gt; Broadband &gt; Cellular Band</b></li> <li>• PIN protection for the SIM card in <b>Network Setting &gt; Broadband &gt; Cellular SIM</b>.</li> </ul> See <a href="#">Chapter 7 on page 117</a> for more details.
Reset	Click this button to reset your Zyxel Device settings back to the factory default.  Note: If none of the above check boxes are selected, the Zyxel Device will reset all settings to the factory defaults.

## 35.4 Reboot

System **Reboot** allows you to restart the Zyxel Device remotely without turning the power off. You may need to do this if the Zyxel Device hangs, for example. This does not affect the Zyxel Device's configuration.

Click **Maintenance > Reboot**. Click **Reboot** to have the Zyxel Device restart.

Figure 224 Maintenance &gt; Reboot

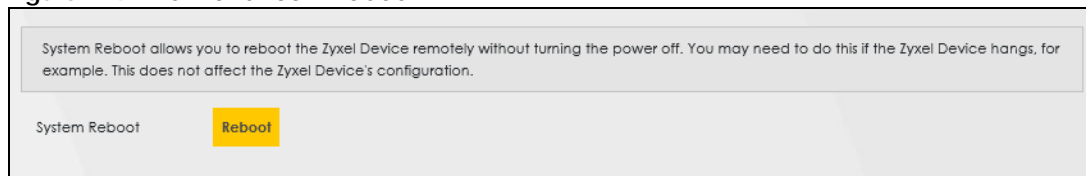

# CHAPTER 36

## Diagnostic

### 36.1 Diagnostic Overview

The **Diagnostic** screen displays information to help you identify Internet connection problems with the Zyxel Device.

#### 36.1.1 What You Can Do in this Chapter

- The **Diagnostic** screen lets you select different methods to test an Internet connection ([Section 36.2 on page 348](#)).

### 36.2 Diagnostic

Use this screen to ping, traceroute, nslookup, or speed test for troubleshooting. Ping and traceroute are used to test whether a particular host is reachable. After entering an IP address and clicking one of the buttons to start a test, the results will be shown in the screen. Use nslookup to find the IP address for a host name and the host name for an IP address. Use speed test to perform an upload and download throughput test for applications such as file transfer, web browsing and email.

Click **Maintenance > Diagnostic** to open the following screen.

Figure 225 Maintenance &gt; Diagnostic

**Diagnostic**

You can use different diagnostic methods to test a connection and see its detailed information. The **Diagnostic** screens display information to help you identify problems with the Zyxel Device.

Perform ping, traceroute, or nslookup for troubleshooting. Ping and traceroute are used to test whether a particular host is reachable. After entering an IP address and clicking one of the buttons to start a test, the results will be shown in the Ping/Traceroute Test area. Use nslookup to find the IP address for a host name and vice versa.

Select Test Method:

**TCP/IP**

Address:

**Start Test**

The following table describes the fields in this screen.

Table 140 Maintenance &gt; Diagnostic

LABEL	DESCRIPTION
	The result of tests is shown here in the info area.
Select Test Method	
Ping	Select this to perform a ping test on the IPv4 address or host name in order to test a connection. The ping statistics will show in the info area.
Ping 6	Select this to perform a ping test on the IPv6 address or host name in order to test a connection. The ping statistics will show in the info area.
Trace Route	Select this to perform the IPv4 trace route function. This determines the path a packet takes to the specified host.
Trace Route 6	Select this to perform the IPv6 trace route function. This determines the path a packet takes to the specified host.
Nslookup	Select this to perform a DNS lookup on the IP address or host name.
TCP/IP	
Address	Enter the IP address of a computer that you want to perform ping, trace route, nslookup, or speed test in order to test a connection.
Start Test	Click this to perform the selected test method.

---

# PART III

# Troubleshooting and Appendices

---

Appendices contain general information. Some information may not apply to your Zyxel Device.

# CHAPTER 37

# Troubleshooting

## 37.1 Troubleshooting Overview

This chapter offers some suggestions to solve problems you might encounter. The potential problems are divided into the following categories.

- [Power and Hardware Problems](#)
- [Device Access Problems](#)
- [Cellular Problems](#)
- [Internet Problems](#)
- [WiFi Problems](#)
- [USB Problems](#)
- [UPnP Problems](#)

## 37.2 Power and Hardware Problems

---

[The Zyxel Device does not turn on.](#)

---

- 1 Make sure you are using the power adapter included with the Zyxel Device.
- 2 Make sure the power adapter is connected to the Zyxel Device and plugged in to an appropriate power source. Make sure the power source is turned on.
- 3 Disconnect and re-connect the power adapter to the Zyxel Device.
- 4 Make sure you have pressed the **POWER** button to turn on the Zyxel Device.
- 5 If the problem continues, contact the vendor.

---

[The LED does not behave as expected.](#)

---

- 1 Make sure you understand the normal behavior of the LED. See [Section 2.2 on page 34](#).
- 2 Check the hardware connections.

- 3 Inspect your cables for damage. Contact the vendor to replace any damaged cables.
- 4 Turn the Zyxel Device off and on.
- 5 If the problem continues, contact the vendor.

## 37.3 Device Access Problems

---

### I do not know the IP address of the Zyxel Device.

---

- 1 The default IP address is 192.168.1.1.
- 2 If you changed the IP address, you might be able to find the IP address of the Zyxel Device by looking up the IP address of your computer's default gateway. To do this in Microsoft Windows, click **Start > Run**, enter **cmd**, and then enter **ipconfig**. The IP address of the **Default Gateway** might be the IP address of the Zyxel Device, depending on your network environment.
- 3 If this does not work, reset the Zyxel Device to its factory defaults.
  - Locate a small hole labeled **RESET** on the Zyxel Device.
  - Use a paperclip or a similar tool to press and hold the **RESET** button.
  - Release the button, and the Zyxel Device will reset to its default settings, including the default IP address, user name, and password.

Note: Resetting the Zyxel Device will erase all your custom settings, so you need to reconfigure it.

---

### I forgot the admin password.

---

- 1 See the Zyxel Device label or this document's cover page for the default admin password.
- 2 If you changed the password from default and cannot remember the new one, you have to reset the Zyxel Device to its factory default settings.

---

### I cannot access the Web Configurator login screen.

---

- 1 Make sure you are using the correct IP address.
  - The default IP address is 192.168.1.1.
  - If you changed the IP address, use the new IP address.
  - If you changed the IP address and have forgotten the new address, see the troubleshooting suggestions for [I do not know the IP address of the Zyxel Device](#).



- 2 Check the hardware connections, and make sure the LEDs are behaving as expected.
- 3 Make sure your Internet browser does not block pop-up windows and has JavaScript and Java enabled.
- 4 Clear the Internet browser cache and try accessing the Web Configurator login screen again.
- 5 Reset the Zyxel Device to its factory default, and try to access the Zyxel Device with the default IP address.
- 6 If the problem continues, contact the network administrator or vendor, or try one of the advanced suggestions.

#### Advanced Suggestions

- Make sure you have logged out of any earlier management sessions using the same user account even if they were through a different interface or using a different browser.
- Try to access the Zyxel Device using another service, such as Telnet. If you can access the Zyxel Device, check the remote management settings and firewall rules to find out why the Zyxel Device does not respond to HTTP.

---

#### I cannot log into the Zyxel Device.

---

- 1 Make sure you have entered the user name and password correctly. The default user name is **admin**. These both user name and password are case-sensitive, so make sure [Caps Lock] is not on.
- 2 You cannot log in to the Web Configurator while someone is using Telnet to access the Zyxel Device. Log out of the Zyxel Device in the other session, or ask the person who is logged in to log out.
- 3 Turn the Zyxel Device off and on.
- 4 If this does not work, you have to reset the Zyxel Device to its factory default.

---

#### I cannot log into the Zyxel Device using DDNS.

---

If you connect your Zyxel Device to the Internet and it uses a dynamic WAN IP address, it is inconvenient for you to manage the Zyxel Device from the Internet. The Zyxel Device's WAN IP address changes dynamically. Dynamic DNS (DDNS) allows you to access the Zyxel Device using a domain name.

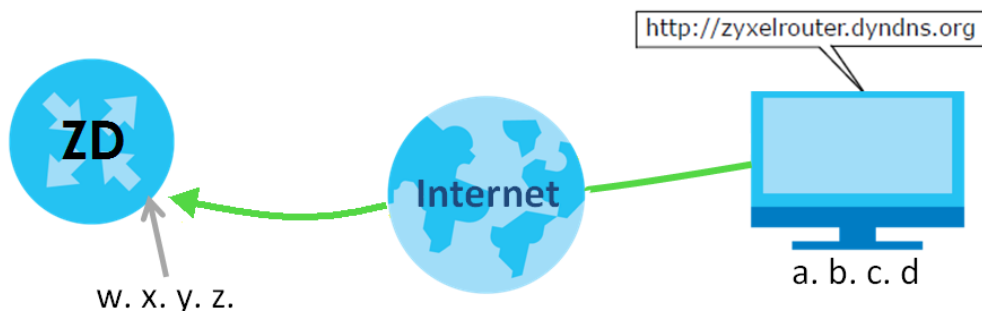

To use this feature, you have to apply for DDNS service at [www.dyndns.org](http://www.dyndns.org).

Note: If you have a private WAN IP address, then you cannot use DDNS.

Here are the three steps to use a domain name to log in the Web Configurator:

#### Step 1 Register for a DDNS Account on [www.dyndns.org](http://www.dyndns.org)

- 1 Open a browser and enter <http://www.dyndns.org>.
- 2 Apply for a user account. This tutorial uses **UserName1** and **12345** as the username and password.
- 3 Log into [www.dyndns.org](http://www.dyndns.org) using your account.
- 4 Add a new DDNS host name. This tutorial uses the following settings as an example.
  - Hostname: **zyxelrouter.dyndns.org**
  - Service Type: **Host with IP address**
  - IP Address: Enter the WAN IP address that your Zyxel Device is currently using. You can find the IP address on the Zyxel Device's Web Configurator **Status** page.

Then you will need to configure the same account and host name on the Zyxel Device later.

#### Step 2 Configure DDNS on Your Zyxel Device

Configure the following settings in the **Network Setting > DNS > Dynamic DNS** screen.

- Select **Enable Dynamic DNS**.
- Select **www.DynDNS.com** as the service provider.
- Enter **zyxelrouter.dyndns.org** in the **Host Name** field.
- Enter the user name (**UserName1**) and password (**12345**). Click **Apply**.

#### Step 3 Test the DDNS Setting

Now you should be able to access the Zyxel Device from the Internet. To test this:

- 1 Open a web browser on the computer (using the IP address **a.b.c.d**) that is connected to the Internet.
- 2 Enter <http://zyxelrouter.dyndns.org> and press [Enter].
- 3 The Zyxel Device's login page should appear. You can then log into the Zyxel Device and manage it.

---

[I cannot connect to the Zyxel Device using Telnet, SSH, or Ping.](#)

---

- 1 See the Remote Management section for details on allowing web services (such as HTTPS, Telnet, SSH and Ping) to access the Zyxel Device.
- 2 Check the server **Port** number field for the web service in the **Maintenance > Remote Management** screen. You must use the same port number in order to use that web service for remote management.

- 3 Try the troubleshooting suggestions for [I cannot access the Web Configurator login screen](#). Ignore the suggestions about your browser.

---

### [I cannot access the Zyxel Device from outside the network \(WAN\).](#)

---

To test if this is due to CGNAT, follow these steps:

- 1 Log in to your Zyxel Device's Web Configurator using the default IPv4 address (for example, 192.168.1.1).
- 2 Locate the WAN IP address on the **Dashboard** screen. You can find this information in the Network or WAN settings.
- 3 Go to a website that can show you the public IP address of your network (for example, <https://whatsmyip.com>). When you access this site, it will display your public IP address.



- 4 Compare the WAN IP address displayed on the **Dashboard** screen with the public IP address shown on the <https://whatsmyip.com> website.
  - If both IP addresses are the same, your ISP is not using Carrier-Grade NAT, and you should be able to access your Zyxel Device from the WAN (outside).
  - If the IP addresses are different, it indicates that your ISP is using Carrier-Grade NAT, and your Zyxel Device has a shared public IP address. As a result, remote access to your Zyxel Device from the WAN will not be possible.

If you discover that your Zyxel Device is behind a Carrier-Grade NAT and you need remote access, you must contact your ISP and request a public IP address for your SIM card or Zyxel Device.

## 37.4 Cellular Problems

---

### [The SIM card cannot be detected.](#)

---

- 1 Disconnect the Zyxel Device from the power supply.
- 2 Remove the SIM card from its slot.
- 3 Clean the SIM card slot of any loose debris using compressed air.
- 4 Clean the gold connectors on the SIM card with a clean lint-free cloth.

- 5 Insert the SIM card into its slot and connect the Zyxel Device to the power supply to restart it.

---

I get an **Invalid SIM card** alert.

---

- 1 Make sure you have an active plan with your ISP.
- 2 Make sure that the Zyxel Device is in the coverage area of a cellular network.
- 3 Enable **Data Roaming** in **Network Setting > Broadband > Cellular WAN** to keep the Zyxel Device connected to the Internet when you are traveling outside the geographical coverage area of the network to which you are registered, such as a different country. Then, restart the Zyxel Device.

---

I get a **weak cellular signal**.

---

- 1 Check the signal strength. Look at the LEDs, and check the LED section for more information. If the signal strength is low, try moving the Zyxel Device closer to the ISP's base station if possible, and look around to see if there are any devices that might be interfering with the wireless network (such as microwaves, other wireless networks).
- 2 Select **Auto** in **Network Setting > Broadband > Cellular Band: Preferred Access Technology** and slide the switch to the right to enable **Band Auto Selection**.
- 3 Find the location of your nearest cellular base stations, then install the Zyxel Device towards the direction of those sites. The nearest site or site with a direct line-of-sight is usually preferred.

Note: It is best to test towards more than one cellular site, as the nearest site / line-of-sight is not always the best due to the terrain, interference, density of usage, and so on. All of these factors influence the stability, availability and throughput of the link to the Zyxel Device.

- 4 Conduct test measurements using the Web Configurator's **System Monitor > Cellular WAN Status** screen to obtain a report of the cellular network signal strength and quality at various test positions.

Note: It is best to reboot the Zyxel Device before each test measurement is taken to ensure that it is not camping on the previous cellular site. This is because the Zyxel Device can 'lock' onto the previous cellular site even when the new cellular site is at a much better signal level and quality.

- 5 Although installing the Zyxel Device as high as possible is the usual rule of thumb, it is sometimes possible that the Zyxel Device is in a weak coverage spot at that specific height. Adjust the height to achieve the best service possible. Use the Zyxel Air App to find the height with the best cellular signal.

It is possible that the current serving cellular site has become over utilized or is out-of-service. In this case, you may need to reposition the Zyxel Device to the direction with the strongest cellular signal. Use the Zyxel Air App to determine the direction with the best cellular signal.

---

## 37.5 Internet Problems

---

### I cannot access the Internet.

---

- 1 Check the hardware connections and make sure the LEDs are behaving as expected. See the **Quick Start Guide**.
- 2 Check the SIM card. Maybe it has wrong settings, the account has expired, it needs to be removed and reinserted (refer to the Quick Start Guide), or it is missing. See [Section 37.7 on page 360](#) for possible SIM card problems.
- 3 Make sure you entered your ISP account information correctly on the **Network Setting > Broadband** screen. Fields on this screen are case-sensitive, so check if [Caps Lock] is on or off.
- 4 Check that the WAN interface you are connected to is in the same interface group as the Ethernet connection (**Network Setting > Interface Group**).
- 5 Make sure you have the Ethernet WAN port connected to a Modem or Router.
- 6 If you set up a WAN connection using bridging service, make sure you turn off the DHCP feature in the **Network Setting > Home Networking > LAN Setup** screen to have the clients get WAN IP addresses directly from your ISP's DHCP server.
- 7 For models that have optional dual LAN/WAN ports, make sure you converted the LAN port to a WAN port by clicking **Enable** on the **Network Setting > Broadband > Ethernet WAN** screen. Then make sure you have the Ethernet WAN port connected to a modem or router.
- 8 If you are trying to access the Internet wirelessly, make sure that you enabled the WiFi in the Zyxel Device and your WiFi client and that the WiFi settings in the WiFi client are the same as the settings in the Zyxel Device.
- 9 Disconnect all the cables from your Zyxel Device and reconnect them.
- 10 If the problem continues, contact your ISP.

---

### I cannot connect to the Internet using an Ethernet connection.

---

- 1 Make sure you have the Ethernet WAN port connected to a Modem or Router.
- 2 Make sure you configured a proper Ethernet WAN interface (**Network Setting > Broadband** screen) with the Internet account information provided by your ISP and that it is enabled.
- 3 Check that the WAN interface you are connected to is in the same interface group as the Ethernet connection (**Network Setting > Interface Group**).
- 4 If you set up a WAN connection using bridging service, make sure you turn off the DHCP feature in the **Network Setting > Home Networking > LAN Setup** screen to have the clients get WAN IP addresses directly from your ISP's DHCP server.

---

I cannot connect to the Internet using a cellular connection.

---

- 1 The DSL and Ethernet connections have priority in that order. If the DSL or Ethernet connection is up, then the cellular connection will be down.
- 2 Make sure you have connected a compatible cellular dongle to the USB port, if required.
- 3 Check that the Zyxel Device is within range of a cellular base station.

---

The Zyxel Device cannot assign individual IP addresses to the connected client devices.

---

- 1 Make sure to select **Bridge** in.
- 2 Make sure to reboot the Zyxel Device after changing to **Bridge** mode.

---

The Internet connection is slow or intermittent.

---

- 1 There might be a lot of traffic on the network. If the Zyxel Device is sending or receiving a lot of information, try closing some programs that use the Internet, especially peer-to-peer applications.
- 2 Check the signal strength – see [I get a weak cellular signal](#).
- 3 For models that support external antennas, see [Section 1.1 on page 17](#). Connect two external antennas to improve the cellular WAN signal strength. Then, set the **INT/EXT / INT EXT / EXT INT** switch to **EXT**. Point the antennas to the base stations directions if you know where they are, or try pointing the antennas in different directions and check which provides the strongest signal to the Zyxel Device. Use the Zyxel Air App to determine the direction with the best cellular signal.
- 4 If your Zyxel Device keeps alternating between ISPs, then choose a fixed ISP. Go to the **Network Setting > Cellular PLMN** screen, disable **PLMN Auto Selection** and then choose your preferred ISP.
- 5 Turn the Zyxel Device off and on.
- 6 If the problem continues, contact the network administrator or vendor, or try the advanced suggestions in [I cannot access the Web Configurator login screen](#).

Note: If your Zyxel Device is an outdoor-type, inclement weather like rain and hot weather may affect cellular signals.

---

What should I do if my Zyxel Device is under attack?

---

A slow Internet speed, your browser keeps redirecting you, suspicious activity alerts from your ISP, and increased pop-ups on the Zyxel Device. These could be signs that your Zyxel Device is under attack. If you suspect that your Zyxel Device is under attack, do the following:

- 1 Create an ACL (Access Control List) rule to block the ports being targeted. See [Section 15.5 on page 238](#) for more information on using ACL. See also [Section 5.6.1 on page 83](#) for more information on configuring a firewall rule. Go to **System Monitor > Log > Security Log** to view the security-related logs to determine which ports are being targeted. See [Section 20.3 on page 293](#) for more information on security logs.
- 2 Contact your ISP to report the attack and seek assistance.
- 3 When possible, turn off the Zyxel Device for 24 hours, then turn it on again.
- 4 Request the ISP to change your IP address.

## 37.6 WiFi Problems

---

[I cannot connect to the Zyxel Device WiFi.](#)

---

- 1 Check the WiFi LED status to make sure the Zyxel Device WiFi is on.
- 2 Make sure your WiFi client is within transmission range of the Zyxel Device.
- 3 Make sure you entered the correct SSID and password. See the Zyxel Device back label for the default SSID and password.
- 4 Make sure your WiFi client is using the same WiFi security type (WPA2-PSK, WPA3-SAE, or none) as the Zyxel Device.
- 5 Make sure the WiFi adapter on your WiFi client is working properly. Right-click your computer's network adapter then select **Properties** to check your network adapter status.
- 6 Make sure the WiFi adapter on your WiFi client is IEEE 802.11-compatible and supports the same WiFi standard as the Zyxel Device radio.

Note: To check if it is your Zyxel Device that is causing the problem and not your WiFi connection, try using a wired connection.

[The WiFi connection is slow and intermittent.](#)

---

The following factors may cause interference:

- Obstacles: walls, ceilings, furniture, and so on.
- Building Materials: metal doors, aluminum studs.

- Electrical devices: microwaves, monitors, electric motors, cordless phones, and other wireless devices.

To optimize the speed and quality of your WiFi connection, you can:

- Move your wireless device closer to the AP if the signal strength is low.
- Reduce wireless interference that may be caused by other WiFi networks or surrounding wireless electronics such as cordless phones.
- Place the AP where there are minimum obstacles (such as walls and ceilings) between the AP and the WiFi client.
- Reduce the number of WiFi clients connecting to the same AP simultaneously, or add additional APs if necessary.
- Try closing some programs that use the Internet, especially peer-to-peer applications. If the WiFi client is sending or receiving a lot of information, it may have too many programs open that use the Internet.
- Place the Zyxel Device where there are minimum obstacles (such as walls and ceilings) between the Zyxel Device and the WiFi client. Avoid placing the Zyxel Device inside any type of box that might block WiFi signals.

## 37.7 USB Problems

---

The Zyxel Device fails to detect my USB device.

---

- 1 Disconnect the USB device.
- 2 Reboot the Zyxel Device.
- 3 If you are connecting a USB hard drive that comes with an external power supply, make sure it is connected to an appropriate power source that is on.
- 4 Reconnect your USB device to the Zyxel Device.

## 37.8 UPnP Problems

---

My computer cannot detect UPnP settings from the Zyxel Device.

---

- 1 Make sure that UPnP is enabled in your computer.
- 2 On the Zyxel Device, make sure that UPnP is enabled on the **Network Settings > Home Networking > UPnP** screen.
- 3 Disconnect the Ethernet cable from the Zyxel Device's Ethernet port or from your computer.



- 4 Reconnect the Ethernet cable.
- 5 Restart your computer.

## 37.9 Getting More Troubleshooting Help

Search for support information for your model at <https://service-provider.zyxel.com/global/en/tech-support> and [community.zyxel.com](https://community.zyxel.com) for more troubleshooting suggestions.

# APPENDIX A

## Customer Support

In the event of problems that cannot be solved by using this manual, you should contact your vendor. If you cannot contact your vendor, then contact a Zyxel office for the region in which you bought the Zyxel Device.

For Zyxel Communication offices, see <https://service-provider.zyxel.com/global/en/contact-us> for the latest information.

For Zyxel Network offices, see <https://www.zyxel.com/index.shtml> for the latest information.

Please have the following information ready when you contact an office.

### Required Information

- Product model and serial number.
- Warranty Information.
- Date that you received your device.
- Brief description of the problem and the steps you took to solve it.

### Corporate Headquarters (Worldwide)

#### Taiwan

- Zyxel Communications (Taiwan) Co., Ltd.
- <https://www.zyxel.com>

### Asia

#### China

- Zyxel Communications Corporation–China Office
- <https://www.zyxel.com/cn/sc>

#### India

- Zyxel Communications Corporation–India Office
- <https://www.zyxel.com/in/en-in>

#### Kazakhstan

- Zyxel Kazakhstan
- <https://www.zyxel.com/ru/ru>

## **Korea**

- Zyxel Korea Co., Ltd.
- <http://www.zyxel.kr/>

## **Malaysia**

- Zyxel Communications Corp.
- <https://www.zyxel.com/global/en>

## **Philippines**

- Zyxel Communications Corp.
- <https://www.zyxel.com/global/en>

## **Singapore**

- Zyxel Communications Corp.
- <https://www.zyxel.com/global/en>

## **Taiwan**

- Zyxel Communications (Taiwan) Co., Ltd.
- <https://www.zyxel.com/tw/zh>

## **Thailand**

- Zyxel Thailand Co., Ltd.
- <https://www.zyxel.com/th/th>

## **Vietnam**

- Zyxel Communications Corporation–Vietnam Office
- <https://www.zyxel.com/vn/vi>

## **Europe**

### **Belarus**

- Zyxel Communications Corp.
- <https://www.zyxel.com/ru/ru>

### **Belgium (Netherlands)**

- Zyxel Benelux
- <https://www.zyxel.com/nl/nl>
- <https://www.zyxel.com/fr/fr>

### **Bulgaria**

- Zyxel Bulgaria

- <https://www.zyxel.com/bg/bg>

## **Czech Republic**

- Zyxel Communications Czech s.r.o.
- <https://www.zyxel.com/cz/cs>

## **Denmark**

- Zyxel Communications A/S
- <https://www.zyxel.com/dk/da>

## **Finland**

- Zyxel Communications
- <https://www.zyxel.com/fi/fi>

## **France**

- Zyxel France
- <https://www.zyxel.com/fr/fr>

## **Germany**

- Zyxel Deutschland GmbH.
- <https://www.zyxel.com/de/de>

## **Hungary**

- Zyxel Hungary & SEE
- <https://www.zyxel.com/hu/hu>

## **Italy**

- Zyxel Communications Italy S.r.l.
- <https://www.zyxel.com/it/it>

## **Norway**

- Zyxel Communications A/S
- <https://www.zyxel.com/no/no>

## **Poland**

- Zyxel Communications Poland
- <https://www.zyxel.com/pl/pl>

## **Romania**

- Zyxel Romania
- <https://www.zyxel.com/ro/ro>

## Russian Federation

- Zyxel Communications Corp.
- <https://www.zyxel.com/ru/ru>

## Slovakia

- Zyxel Slovakia
- <https://www.zyxel.com/sk/sk>

## Spain

- Zyxel Iberia
- <https://www.zyxel.com/es/es>

## Sweden

- Zyxel Communications A/S
- <https://www.zyxel.com/se/sv>

## Switzerland

- Studerus AG
- <https://www.zyxel.com/ch/de-ch>
- <https://www.zyxel.com/fr/fr>

## Turkey

- Zyxel Turkey A.S.
- <https://www.zyxel.com/tr/tr>

## UK

- Zyxel Communications UK Ltd.
- <https://www.zyxel.com/uk/en-gb>

## Ukraine

- Zyxel Ukraine
- <https://www.zyxel.com/ua/uk-ua>

## South America

### Argentina

- Zyxel Communications Corp.
- <https://www.zyxel.com/co/es-co>

### Brazil

- Zyxel Communications Brasil Ltda.

- <https://www.zyxel.com/br/pt>

## **Colombia**

- Zyxel Communications Corp.
- <https://www.zyxel.com/co/es-co>

## **Ecuador**

- Zyxel Communications Corp.
- <https://www.zyxel.com/co/es-co>

## **South America**

- Zyxel Communications Corp.
- <https://www.zyxel.com/co/es-co>

## **Middle East**

### **Israel**

- Zyxel Communications Corp.
- <https://il.zyxel.com>

## **North America**

### **USA**

- Zyxel Communications, Inc. – North America Headquarters
- <https://www.zyxel.com/us/en-us>

# APPENDIX B

## IPv6

### Overview

IPv6 (Internet Protocol version 6), is designed to enhance IP address size and features. The increase in IPv6 address size to 128 bits (from the 32-bit IPv4 address) allows up to  $3.4 \times 10^{38}$  IP addresses.

### IPv6 Addressing

The 128-bit IPv6 address is written as eight 16-bit hexadecimal blocks separated by colons (:). This is an example IPv6 address `2001:0db8:1a2b:0015:0000:0000:1a2f:0000`.

IPv6 addresses can be abbreviated in two ways:

- Leading zeros in a block can be omitted. So `2001:0db8:1a2b:0015:0000:0000:1a2f:0000` can be written as `2001:db8:1a2b:15:0:0:1a2f:0`.
- Any number of consecutive blocks of zeros can be replaced by a double colon. A double colon can only appear once in an IPv6 address. So `2001:0db8:0000:0000:1a2f:0000:0000:0015` can be written as `2001:0db8::1a2f:0000:0000:0015`, `2001:0db8:0000:0000:1a2f::0015`, `2001:db8::1a2f:0:0:15` or `2001:db8:0:0:1a2f::15`.

### Prefix and Prefix Length

Similar to an IPv4 subnet mask, IPv6 uses an address prefix to represent the network address. An IPv6 prefix length specifies how many most significant bits (start from the left) in the address compose the network address. The prefix length is written as “/x” where x is a number. For example,

`2001:db8:1a2b:15::1a2f:0/32`

means that the first 32 bits (`2001:db8`) is the subnet prefix.

### Link-local Address

A link-local address uniquely identifies a device on the local network (the LAN). It is similar to a “private IP address” in IPv4. You can have the same link-local address on multiple interfaces on a device. A link-local unicast address has a predefined prefix of `fe80::/10`. The link-local unicast address format is as follows.

Table 141 Link-local Unicast Address Format

1111 1110 10	0	Interface ID
10 bits	54 bits	64 bits

### Global Address

A global address uniquely identifies a device on the Internet. It is similar to a “public IP address” in IPv4. A global unicast address starts with a 2 or 3.

## Unspecified Address

An unspecified address (0:0:0:0:0:0 or ::) is used as the source address when a device does not have its own address. It is similar to "0.0.0.0" in IPv4.

## Loopback Address

A loopback address (0:0:0:0:0:1 or ::1) allows a host to send packets to itself. It is similar to "127.0.0.1" in IPv4.

## Multicast Address

In IPv6, Multicast addresses provide the same functionality as IPv4 broadcast addresses. Broadcasting is not supported in IPv6. A Multicast address allows a host to send packets to all hosts in a Multicast group.

Multicast scope allows you to determine the size of the Multicast group. A Multicast address has a predefined prefix of ff00::/8. The following table describes some of the predefined Multicast addresses.

Table 142 Predefined Multicast Address

MULTICAST ADDRESS	DESCRIPTION
FF01:0:0:0:0:0:0:1	All hosts on a local node.
FF01:0:0:0:0:0:0:2	All routers on a local node.
FF02:0:0:0:0:0:0:1	All hosts on a local connected link.
FF02:0:0:0:0:0:0:2	All routers on a local connected link.
FF05:0:0:0:0:0:0:2	All routers on a local site.
FF05:0:0:0:0:0:1:3	All DHCP servers on a local site.

The following table describes the Multicast addresses which are reserved and cannot be assigned to a Multicast group.

Table 143 Reserved Multicast Address

MULTICAST ADDRESS
FF00:0:0:0:0:0:0:0
FF01:0:0:0:0:0:0:0
FF02:0:0:0:0:0:0:0
FF03:0:0:0:0:0:0:0
FF04:0:0:0:0:0:0:0
FF05:0:0:0:0:0:0:0
FF06:0:0:0:0:0:0:0
FF07:0:0:0:0:0:0:0
FF08:0:0:0:0:0:0:0
FF09:0:0:0:0:0:0:0
FF0A:0:0:0:0:0:0:0
FF0B:0:0:0:0:0:0:0
FF0C:0:0:0:0:0:0:0
FF0D:0:0:0:0:0:0:0
FF0E:0:0:0:0:0:0:0
FF0F:0:0:0:0:0:0:0



## Subnet Masking

Both an IPv6 address and IPv6 subnet mask compose of 128-bit binary digits, which are divided into eight 16-bit blocks and written in hexadecimal notation. Hexadecimal uses four bits for each character (1 – 10, A – F). Each block's 16 bits are then represented by four hexadecimal characters. For example, FFFF:FFFF:FFFF:FFFF:FC00:0000:0000:0000.

## Interface ID

In IPv6, an interface ID is a 64-bit identifier. It identifies a physical interface (for example, an Ethernet port) or a virtual interface (for example, the management IP address for a VLAN). One interface should have a unique interface ID.

## EUI-64

The EUI-64 (Extended Unique Identifier) defined by the IEEE (Institute of Electrical and Electronics Engineers) is an interface ID format designed to adapt with IPv6. It is derived from the 48-bit (6-byte) Ethernet MAC address as shown next. EUI-64 inserts the hex digits fffe between the third and fourth bytes of the MAC address and complements the seventh bit of the first byte of the MAC address. See the following example.

**Table 144**

MAC	00	: 13	: 49	: 12	: 34	: 56
-----	----	------	------	------	------	------

**Table 145**

EUI-64	02	: 13	: 49	: FF	: FE	: 12	: 34	: 56
--------	----	------	------	------	------	------	------	------

## Identity Association

An Identity Association (IA) is a collection of addresses assigned to a DHCP client, through which the server and client can manage a set of related IP addresses. Each IA must be associated with exactly one interface. The DHCP client uses the IA assigned to an interface to obtain configuration from a DHCP server for that interface. Each IA consists of a unique IAID and associated IP information.

The IA type is the type of address in the IA. Each IA holds one type of address. IA\_NA means an identity association for non-temporary addresses and IA\_TA is an identity association for temporary addresses. An IA\_NA option contains the T1 and T2 fields, but an IA\_TA option does not. The DHCPv6 server uses T1 and T2 to control the time at which the client contacts with the server to extend the lifetimes on any addresses in the IA\_NA before the lifetimes expire. After T1, the client sends the server (S1) (from which the addresses in the IA\_NA were obtained) a Renew message. If the time T2 is reached and the server does not respond, the client sends a Rebind message to any available server (S2). For an IA\_TA, the client may send a Renew or Rebind message at the client's discretion.

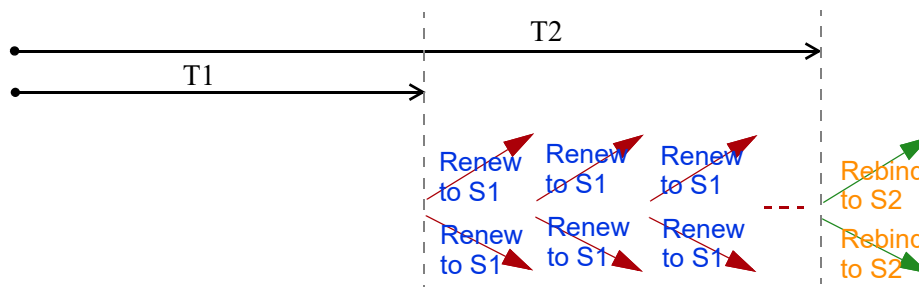

## DHCP Relay Agent

A DHCP relay agent is on the same network as the DHCP clients and helps forward messages between the DHCP server and clients. When a client cannot use its link-local address and a well-known multicast address to locate a DHCP server on its network, it then needs a DHCP relay agent to send a message to a DHCP server that is not attached to the same network.

The DHCP relay agent can add the remote identification (remote-ID) option and the interface-ID option to the Relay-Forward DHCPv6 messages. The remote-ID option carries a user-defined string, such as the system name. The interface-ID option provides slot number, port information and the VLAN ID to the DHCPv6 server. The remote-ID option (if any) is stripped from the Relay-Reply messages before the relay agent sends the packets to the clients. The DHCP server copies the interface-ID option from the Relay-Forward message into the Relay-Reply message and sends it to the relay agent. The interface-ID should not change even after the relay agent restarts.

## Prefix Delegation

Prefix delegation enables an IPv6 router to use the IPv6 prefix (network address) received from the ISP (or a connected uplink router) for its LAN. The Zyxel Device uses the received IPv6 prefix (for example, 2001:db2::/48) to generate its LAN IP address. Through sending Router Advertisements (RAs) regularly by Multicast, the Zyxel Device passes the IPv6 prefix information to its LAN hosts. The hosts then can use the prefix to generate their IPv6 addresses.

## ICMPv6

Internet Control Message Protocol for IPv6 (ICMPv6 or ICMP for IPv6) is defined in RFC 4443. ICMPv6 has a preceding Next Header value of 58, which is different from the value used to identify ICMP for IPv4. ICMPv6 is an integral part of IPv6. IPv6 nodes use ICMPv6 to report errors encountered in packet processing and perform other diagnostic functions, such as "ping".

## Neighbor Discovery Protocol (NDP)

The Neighbor Discovery Protocol (NDP) is a protocol used to discover other IPv6 devices and track neighbor's reachability in a network. An IPv6 device uses the following ICMPv6 messages types:

- Neighbor solicitation: A request from a host to determine a neighbor's link-layer address (MAC address) and detect if the neighbor is still reachable. A neighbor being "reachable" means it responds to a neighbor solicitation message (from the host) with a neighbor advertisement message.
- Neighbor advertisement: A response from a node to announce its link-layer address.
- Router solicitation: A request from a host to locate a router that can act as the default router and forward packets.
- Router advertisement: A response to a router solicitation or a periodical Multicast advertisement from a router to advertise its presence and other parameters.

## IPv6 Cache

An IPv6 host is required to have a neighbor cache, destination cache, prefix list and default router list. The Zyxel Device maintains and updates its IPv6 caches constantly using the information from response messages. In IPv6, the Zyxel Device configures a link-local address automatically, and then sends a neighbor solicitation message to check if the address is unique. If there is an address to be resolved or verified, the Zyxel Device also sends out a neighbor solicitation message. When the Zyxel Device

receives a neighbor advertisement in response, it stores the neighbor's link-layer address in the neighbor cache. When the Zyxel Device uses a router solicitation message to query for a router and receives a router advertisement message, it adds the router's information to the neighbor cache, prefix list and destination cache. The Zyxel Device creates an entry in the default router list cache if the router can be used as a default router.

When the Zyxel Device needs to send a packet, it first consults the destination cache to determine the next hop. If there is no matching entry in the destination cache, the Zyxel Device uses the prefix list to determine whether the destination address is on-link and can be reached directly without passing through a router. If the address is un-link, the address is considered as the next hop. Otherwise, the Zyxel Device determines the next-hop from the default router list or routing table. Once the next hop IP address is known, the Zyxel Device looks into the neighbor cache to get the link-layer address and sends the packet when the neighbor is reachable. If the Zyxel Device cannot find an entry in the neighbor cache or the state for the neighbor is not reachable, it starts the address resolution process. This helps reduce the number of IPv6 solicitation and advertisement messages.

## Multicast Listener Discovery

The Multicast Listener Discovery (MLD) protocol (defined in RFC 2710) is derived from IPv4's Internet Group Management Protocol version 2 (IGMPv2). MLD uses ICMPv6 message types, rather than IGMP message types. MLDv1 is equivalent to IGMPv2 and MLDv2 is equivalent to IGMPv3.

MLD allows an IPv6 switch or router to discover the presence of MLD listeners who wish to receive Multicast packets and the IP addresses of Multicast groups the hosts want to join on its network.

MLD snooping and MLD proxy are analogous to IGMP snooping and IGMP proxy in IPv4.

MLD filtering controls which Multicast groups a port can join.

## MLD Messages

A Multicast router or switch periodically sends general queries to MLD hosts to update the Multicast forwarding table. When an MLD host wants to join a Multicast group, it sends an MLD Report message for that address.

An MLD Done message is equivalent to an IGMP Leave message. When an MLD host wants to leave a Multicast group, it can send a Done message to the router or switch. The router or switch then sends a group-specific query to the port on which the Done message is received to determine if other devices connected to this port should remain in the group.

## Example – Enabling IPv6 on Windows 10

Windows 10 supports IPv6 by default. DHCPv6 is also enabled when you enable IPv6 on a Windows 10 computer.

To enable IPv6 in Windows 10:

- 1 Click the start icon, **Settings** and then **Network & Internet**.
- 2 Select the **Internet Protocol Version 6 (TCP/IPv6)** checkbox to enable it.
- 3 Click **OK** to save the change.

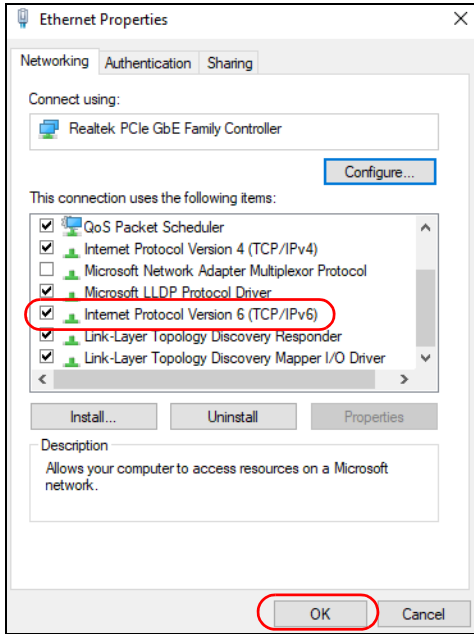

- 4 Click the Search icon (  ) and then enter "cmd" in the search box.
- 5 Use the `ipconfig` command to check your dynamic IPv6 address. This example shows a global address (2001:b021:2d::1000) obtained from a DHCP server.

```

C:\>ipconfig

Windows IP Configuration

Ethernet adapter Local Area Connection:

    Connection-specific DNS Suffix  . : 
    IPv6 Address. . . . . : 2001:b021:2d::1000
    Link-local IPv6 Address . . . . . : fe80::25d8:dcab:c80a:5189%11
    IPv4 Address. . . . . : 172.16.100.61
    Subnet Mask . . . . . : 255.255.255.0
    Default Gateway . . . . . : fe80::213:49ff:f
  
```

# APPENDIX C

## Legal Information

### Copyright

Copyright © 2024 by Zyxel and/or its affiliates.

The contents of this publication may not be reproduced in any part or as a whole, transcribed, stored in a retrieval system, translated into any language, or transmitted in any form or by any means, electronic, mechanical, magnetic, optical, chemical, photocopying, manual, or otherwise, without the prior written permission of Zyxel and/or its affiliates.

Published by Zyxel and/or its affiliates. All rights reserved.

### Disclaimer

Zyxel does not assume any liability arising out of the application or use of any products, or software described herein. Neither does it convey any license under its patent rights nor the patent rights of others. Zyxel further reserves the right to make changes in any products described herein without notice. This publication is subject to change without notice.

### Regulatory Notice and Statement

#### Europe and the United Kingdom



The following information applies if you use the product within the European Union and United Kingdom.

#### Declaration of Conformity with Regard to EU Directive 2014/53/EU (Radio Equipment Directive, RED) and UK Radio Equipment Regulations 2017

- Compliance information for wireless products relevant to the EU, United Kingdom and other Countries following the EU Directive 2014/53/EU (RED) and UK regulation. And this product may be used in all EU countries (and other countries following the EU Directive 2014/53/EU) and United Kingdom without any limitation except for the countries mentioned below table:
- In the majority of the EU, United Kingdom and other European countries, the 5 GHz bands have been made available for the use of wireless local area networks (LANs). Later in this document you will find an overview of countries in which additional restrictions or requirements or both are applicable. The requirements for any country may evolve. Zyxel recommends that you check with the local authorities for the latest status of their national regulations for the 5 GHz wireless LANs.
- If this device for operation in the band 5150 – 5350 MHz, it is for indoor use only.
- This equipment should be installed and operated with a minimum distance of 20 cm between the radio equipment and your body.
- The maximum RF power operating for each band as follows:
- NR5101
  - WCDMA band I/III/VIII is 24 dBm.
  - LTE band 1/3/7/8/20/28/34/38/40/42/43 is 23 dBm.
  - NR band n41/n77/n78 is 26 dBm.
  - WiFi
    - The band 2400 – 2483.5 MHz is 90.16 mW,
    - The band 5150 – 5350 MHz is 177.42 mW,
    - The band 5470 – 5725 MHz is 451.86 mW.
- NR5103 / FWA510
  - WCDMA band I/VIII is 24 dBm.
  - LTE band 1/3/7/8/20/28/38/40/42 is 23 dBm.
  - NR band n1/n3/n28/n38/n78 is 26 dBm.
  - WiFi
    - The band 2400 – 2483.5 MHz is 90.16 mW,
    - The band 5150 – 5350 MHz is 174.58 mW,
    - The band 5470 – 5725 MHz is 857.04 mW.
- NR5103E
  - WCDMA band I/VIII is 24 dBm.
  - LTE band 1/3/7/8/20/28/38/40/42 is 23 dBm.
  - NR band n1/n3/n28/n38/n78 is 26 dBm.
  - WiFi
    - The band 2400 – 2483.5 MHz is 95.72 mW,
    - The band 5150 – 5350 MHz is 184.08 mW,
    - The band 5470 – 5725 MHz is 618.02 mW.
- NR5103EV2

- WCDMA band I/VIII is 24 dBm.
- LTE band 1/3/7/8/20/28/38/40/42 is 25 dBm.
- NR band n1/n3/n7/n8/n20/n28/n38/n40 is 25 dBm.
- NR band n77/n78 is 28 dBm.
- WiFi
  - The band 2400 – 2483.5 MHz is 20 dBm,
  - The band 5150 – 5350 MHz is 23 dBm,
  - The band 5470 – 5725 MHz is 30 dBm.
- NR5103EV3
  - WCDMA band I/VIII is 24 dBm.
  - LTE band 1/3/7/8/20/28/38/40/42/43 is 25 dBm.
  - NR band n1/n3/n7/n8/n20/n28/n38 is 25 dBm.
  - NR band n40/n77/n78 is 28 dBm.
- WiFi
  - The band 2400 – 2483.5 MHz is 20 dBm,
  - The band 5150 – 5350 MHz is 23 dBm,
  - The band 5470 – 5725 MHz is 30 dBm.
- NR5307
  - LTE band 1/3/7/8/20/28/32/38/40/42 is 25 dBm.
  - NR band n1/n3/n7/n8/n20/n28/n38 is 25 dBm.
  - NR band n40 is 28 dBm.
  - NR band n77/n78 is 31 dBm.
- WiFi
  - The band 2400 – 2483.5 MHz is 20 dBm,
  - The band 5150 – 5350 MHz is 23 dBm,
  - The band 5470 – 5725 MHz is 30 dBm.

Belgium (English)	<b>National Restrictions</b>
België (Flemish)	<ul style="list-style-type: none"> <li>• The Belgian Institute for Postal Services and Telecommunications (BIPT) must be notified of any outdoor wireless link having a range exceeding 300 meters. Please check <a href="http://www.bipt.be">http://www.bipt.be</a> for more details.</li> <li>• Draadloze verbindingen voor buitengebruik en met een reikwijdte van meer dan 300 meter dienen aangemeld te worden bij het Belgisch Instituut voor postdiensten en telecommunicatie (BIPT). Zie <a href="http://www.bipt.be">http://www.bipt.be</a> voor meer gegevens.</li> <li>• Les liaisons sans fil pour une utilisation en extérieur d'une distance supérieure à 300 mètres doivent être notifiées à l'Institut Belge des services Postaux et des Télécommunications (IBPT). Visitez <a href="http://www.ibpt.be">http://www.ibpt.be</a> pour de plus amples détails.</li> </ul>
Belgique (French)	
Čeština (Czech)	
Dansk (Danish)	Undertegnede Zyxel erklærer herved, at følgende udstyr overholder de væsentlige krav og øvrige relevante krav i direktiv 2014/53/EU.
Deutsch (German)	Hiermit erklärt Zyxel, dass sich das Gerät Ausstattung in Übereinstimmung mit den grundlegenden Anforderungen und den übrigen einschlägigen Bestimmungen der Richtlinie 2014/53/EU befindet.
Eesti keel (Estonian)	Käesolevaga kinnitab Zyxel seadme vastavust direktiivi 2014/53/EL põhinõuetele ja nimetatud direktiivist tulenevatele teistele asjakohastele sätetele.
Ελληνικά (Greek)	ΜΕ ΤΗΝ ΠΑΡΟΥΣΙΑ Ζyxel ΔΗΛΩΝΕΙ ΟΤΙ ΕΞΟΠΛΙΣΜΟΣ ΣΥΜΜΟΡΦΩΝΕΤΑΙ ΠΡΟΣ ΤΙΣ ΟΥΣΙΩΔΕΙΣ ΑΠΑΙΤΗΣΕΙΣ ΚΑΙ ΤΙΣ ΛΟΙΠΕΣ ΣΧΕΤΙΚΕΣ ΔΙΑΤΑΞΕΙΣ ΤΗΣ ΟΔΗΓΙΑΣ 2014/53/ΕΕ.
English	Hereby, Zyxel declares that this device is in compliance with the essential requirements and other relevant provisions of Directive 2014/53/EU.
Español (Spanish)	Por medio de la presente Zyxel declara que el equipo cumple con los requisitos esenciales y cualesquiera otras disposiciones aplicables o exigibles de la Directiva 2014/53/UE.
Français (French)	Par la présente Zyxel déclare que l'appareil équipements est conforme aux exigences essentielles et aux autres dispositions pertinentes de la directive 2014/53/UE.
Hrvatski (Croatian)	Zyxel ovime izjavljuje da je radijska oprema tipa u skladu s Direktivom 2014/53/UE.
Íslenska (Icelandic)	Hér með lýsir, Zyxel því yfir að þessi búnaður er í samræmi við grunnkröfur og önnur viðeigandi ákvæði tilskipunar 2014/53/UE.
Italiano (Italian)	Con la presente Zyxel dichiara che questo attrezzatura è conforme ai requisiti essenziali ed alle altre disposizioni pertinenti stabilite dalla direttiva 2014/53/UE.  National Restrictions <ul style="list-style-type: none"> <li>• This product meets the National Radio Interface and the requirements specified in the National Frequency Allocation Table for Italy. Unless this wireless LAN product is operating within the boundaries of the owner's property, its use requires a "general authorization." Please check <a href="https://www.mise.gov.it/">https://www.mise.gov.it/</a> for more details.</li> <li>• Questo prodotto è conforme alle specifiche di Interfaccia Radio Nazionali e rispetta il Piano Nazionale di ripartizione delle frequenze in Italia. Se non viene installato all'interno del proprio fondo, l'utilizzo di prodotti Wireless LAN richiede una "Autorizzazione Generale". Consultare <a href="https://www.mise.gov.it/">https://www.mise.gov.it/</a> per maggiori dettagli.</li> </ul>
Latviešu valoda (Latvian)	Ar šo Zyxel deklarē, ka iekārtas atbilst Direktīvas 2014/53/ES būtiskajām prasībām un citiem ar to saistītajiem noteikumiem.

Lietuvių kalba (Lithuanian)	Šiuo Zyxel deklaruoja, kad šis įranga atitinka esminius reikalavimus ir kitas 2014/53/ES Direktyvos nuostatas.
Magyar (Hungarian)	Alulírott, Zyxel nyilatkozom, hogy a berendezés megfelel a vonatkozó alapvető követelményeknek és az 2014/53/EU irányelv egyéb előírásainak.
Malti (Maltese)	Hawnhekk, Zyxel, jiddikjara li dan tagħmir jikkonforma mal-ftiġijiet essenzjali u ma provvedimenti oħrajn rilevanti li hemm fid-Direttiva 2014/53/UE.
Nederlands (Dutch)	Hierbij verklaart Zyxel dat het toestel uitrusting in overeenstemming is met de essentiële eisen en de andere relevante bepalingen van richtlijn 2014/53/EU.
Norsk (Norwegian)	Erklærer herved Zyxel at dette utstyret er i samsvar med de grunnleggende kravene og andre relevante bestemmelser i direktiv 2014/53/EU.
Polski (Polish)	Niniejszym Zyxel oświadcza, że sprzęt jest zgodny z zasadniczymi wymogami oraz pozostałymi stosownymi postanowieniami Dyrektywy 2014/53/UE.
Português (Portuguese)	Zyxel declara que este equipamento está conforme com os requisitos essenciais e outras disposições da Directiva 2014/53/UE.
Română (Romanian)	Prin prezenta, Zyxel declară că acest echipament este în conformitate cu cerințele esențiale și alte prevederi relevante ale Directivei 2014/53/UE.
Slovenčina (Slovak)	Zyxel týmto vyhlasuje, že zariadenia spĺňa základné požiadavky a všetky príslušné ustanovenia Smernice 2014/53/EÚ.
Slovenščina (Slovene)	Zyxel izjavlja, da je ta oprema v skladu z bistvenimi zahtevami in ostalimi relevantnimi določili direktive 2014/53/EU.
Suomi (Finnish)	Zyxel vakuuttaa täten että laitteet tyyppinen laite on direktiivin 2014/53/EU oleellisten vaatimusten ja sitä koskevien direktiivin muiden ehtojen mukainen.
Svenska (Swedish)	Härmed intygar Zyxel att denna utrustning står i överensstämmelse med de väsentliga egenskapskrav och övriga relevanta bestämmelser som framgår av direktiv 2014/53/EU.
Български (Bulgarian)	С настоящото Zyxel декларира, че това оборудване е в съответствие със съществените изисквания и другите приложими разпоредбите на Директива 2014/53/ЕС.

**Notes:**

- Not all European states that implement EU Directive 2014/53/EU are European Union (EU) members.
- The regulatory limits for maximum output power are specified in EIRP. The EIRP level (in dBm) of a device can be calculated by adding the gain of the antenna used (specified in dBi) to the output power available at the connector (specified in dBm).

**List of national codes**

COUNTRY	ISO 3166 2 LETTER CODE	COUNTRY	ISO 3166 2 LETTER CODE
Austria	AT	Liechtenstein	LI
Belgium	BE	Lithuania	LT
Bulgaria	BG	Luxembourg	LU
Croatia	HR	Malta	MT
Cyprus	CY	Netherlands	NL
Czech Republic	CZ	Norway	NO
Denmark	DK	Poland	PL
Estonia	EE	Portugal	PT
Finland	FI	Romania	RO
France	FR	Serbia	RS
Germany	DE	Slovakia	SK
Greece	GR	Slovenia	SI
Hungary	HU	Spain	ES
Iceland	IS	Switzerland	CH
Ireland	IE	Sweden	SE
Italy	IT	Turkey	TR
Latvia	LV	United Kingdom	GB

**Safety Warnings**

- Do not put the device in a place that is humid, dusty or has extreme temperatures as these conditions may harm your device.
- Please refer to the device back label, datasheet, box specifications or catalog information for the power rating of the device and operating temperature.

- Do not use this product near water, for example, in a wet basement or near a swimming pool.
- Do not expose your Zyxel Device to dampness, dust or corrosive liquids.
- Do not store things on the device.
- Do not obstruct the device ventilation slots as insufficient airflow may harm your device. For example, do not place the device in an enclosed space such as a box or on a very soft surface such as a bed or sofa.
- Do not install or service this device during a thunderstorm. There is a remote risk of electric shock from lightning.
- Connect ONLY suitable accessories to the device.
- Do not open the device. Opening or removing the device covers can expose you to dangerous high voltage points or other risks.
- Only qualified service personnel should service or disassemble this device. Please contact your vendor for further information.
- Make sure to connect the cables to the correct ports.
- Place connected cables carefully so that no one will step on them or stumble over them.
- Disconnect all cables from this device before servicing or disassembling.
- Do not remove the plug and connect it to a power outlet by itself; always attach the plug to the power adaptor first before connecting it to a power outlet.
- Do not allow anything to rest on the power adaptor or cord and do NOT place the product where anyone can walk on the power adaptor or cord.
- Please use the provided or designated connection cables/power cables/adaptors. Connect the power adaptor or cord to the right supply voltage (for example, 120V AC in North America or 230V AC in Europe). If the power adaptor or cord is damaged, it might cause electrocution. Remove the damaged power adaptor or cord from the device and the power source. Do not try to repair the power adaptor or cord by yourself. Contact your local vendor to order a new one.
- CAUTION: There is a risk of explosion if you replace the device battery with an incorrect one. Dispose of used batteries according to the instruction. Dispose them at the applicable collection point for the recycling of electrical and electronic devices. For detailed information about recycling of this device, please contact your local city office, your household waste disposal service, or the store where you purchased the device.
- The following warning statements apply, where the disconnect device is not incorporated in the device or where the plug on the power supply cord is intended to serve as the disconnect device:
  - For a permanently connected device, a readily accessible method to disconnect the device shall be incorporated externally to the device;
  - For a pluggable device, the socket-outlet shall be installed near the device and shall be easily accessible.

## Environment Statement

### ErP (Energy-related Products)

Zyxel products put on the EU and United Kingdom market in compliance with the requirement of the European Parliament and the Council published Directive 2009/125/EC and UK regulation establishing a framework for the setting of ecodesign requirements for energy-related products (recast), so called as "ErP Directive (Energy-related Products directive)" as well as ecodesign requirement laid down in applicable implementing measures, power consumption has satisfied regulation requirements which are:

- Network standby power consumption < 8W, and/or
- Off mode power consumption < 0.5W, and/or
- Standby mode power consumption < 0.5W.

(Wireless settings, please refer to the chapter about wireless settings for more detail.)

### Disposal and Recycling Information

The symbol below means that according to local regulations your product and/or its battery shall be disposed of separately from domestic waste. If this product is end of life, take it to a recycling station designated by local authorities. At the time of disposal, the separate collection of your product and/or its battery will help save natural resources and ensure that the environment is sustainable development.

Die folgende Symbol bedeutet, dass Ihr Produkt und/oder seine Batterie gemäß den örtlichen Bestimmungen getrennt vom Hausmüll entsorgt werden muss. Wenden Sie sich an eine Recyclingstation, wenn dieses Produkt das Ende seiner Lebensdauer erreicht hat. Zum Zeitpunkt der Entsorgung wird die getrennte Sammlung von Produkt und/oder seiner Batterie dazu beitragen, natürliche Ressourcen zu sparen und die Umwelt und die menschliche Gesundheit zu schützen.

El símbolo de abajo indica que según las regulaciones locales, su producto y/o su batería deberán depositarse como basura separada de la doméstica. Cuando este producto alcance el final de su vida útil, llévelo a un punto limpio. Cuando llegue el momento de desechar el producto, la recogida por separado éste y/o su batería ayudará a salvar los recursos naturales y a proteger la salud humana y medioambiental.

Le symbole ci-dessous signifie que selon les réglementations locales votre produit et/ou sa batterie doivent être éliminés séparément des ordures ménagères. Lorsque ce produit atteint sa fin de vie, amenez-le à un centre de recyclage. Au moment de la mise au rebut, la collecte séparée de votre produit et/ou de sa batterie aidera à économiser les ressources naturelles et protéger l'environnement et la santé humaine.

Il simbolo sotto significa che secondo i regolamenti locali il vostro prodotto e/o batteria deve essere smaltito separatamente dai rifiuti domestici. Quando questo prodotto raggiunge la fine della vita di servizio portarlo a una stazione di riciclaggio. Al momento dello smaltimento, la raccolta separata del vostro prodotto e/o della sua batteria aiuta a risparmiare risorse naturali e a proteggere l'ambiente e la salute umana.

Symbolen innebär att enligt lokal lagstiftning ska produkten och/eller dess batteri kastas separat från hushållsavfallet. När den här produkten når slutet av sin livslängd ska du ta den till en återvinningsstation. Vid tiden för kasseringen bidrar du till en bättre miljö och mänsklig hälsa genom att göra dig av med den på ett återvinningsställe.





台灣



以下訊息僅適用於產品具有無線功能且銷售至台灣地區：

- 第十二條 經型式認證合格之低功率射頻電機，非經許可，公司、商號或使用者均不得擅自變更頻率、加大功率或變更原設計之特性及功能。
- 第十四條 低功率射頻電機之使用不得影響飛航安全及干擾合法通信；經發現有干擾現象時，應立即停用，並改善至無干擾時方得繼續使用。前項合法通信，指依電信法規定作業之無線電通信。低功率射頻電機須忍受合法通信或工業、科學及醫療用電波輻射性電機設備之干擾。
- 無線資訊傳輸設備須忍受合法通信之干擾且不得干擾合法通信；如造成干擾，應立即停用，俟無干擾之虞，始得繼續使用。
- 無線資訊傳輸設備的製造廠商應確保頻率穩定性，如依製造廠商使用手冊上所述正常操作，發射的信號應維持於操作頻帶中。
- 使用無線產品時，應避免影響附近雷達系統之操作。
- 高增益指向性天線只得應用於固定式點對點系統。

以下訊息僅適用於產品屬於專業安裝並銷售至台灣地區：

- 本器材須經專業工程人員安裝及設定，始得設置使用，且不得直接販售給一般消費者。





安全警告 – 為了您的安全，請先閱讀以下警告及指示：

- 請勿將此產品接近水、火焰或放置在高溫的環境。
- 避免設備接觸：
  - 任何液體 – 切勿讓設備接觸水、雨水、高濕度、污水腐蝕性的液體或其他水份。
  - 灰塵及污物 – 切勿接觸灰塵、污物、沙土、食物或其他不適合的材料。
- 雷雨天氣時，不要安裝或維修此設備。有遭受電擊的風險。
- 切勿重摔或撞擊設備，並勿使用不正確的電源變壓器。
- 若接上不正確的電源變壓器會有爆炸的風險。
- 請勿隨意更換產品內的電池。
- 如果更換不正確之電池型式，會有爆炸的風險，請依製造商說明書處理使用過之電池。
- 請將廢電池丟棄在適當的電器或電子設備回收處。
- 請勿將設備解體。
- 請勿阻礙設備的散熱孔，空氣對流不足將會造成設備損害。
- 請使用隨貨提供或指定的連接線 / 電源線 / 電源變壓器，將其連接到合適的供應電壓（如：台灣供應電壓 110 伏特）。
- 假若電源變壓器或電源變壓器的纜線損壞，請從插座拔除，若您繼續插電使用，會有觸電死亡的風險。
- 請勿試圖修理電源變壓器或電源變壓器的纜線，若有毀損，請直接聯絡您購買的店家，購買一個新的電源變壓器。
- 請勿將此設備安裝於室外，此設備僅適合放置於室內。
- 請勿隨一般垃圾丟棄。
- 請參閱產品背貼上的設備額定功率。
- 請參考產品型錄或是彩盒上的作業溫度。
- 產品沒有斷電裝置或者採用電源線的插頭視為斷電裝置的一部分，以下警語將適用：
  - 對永久連接之設備，在設備外部須安裝可觸及之斷電裝置；
  - 對插接式之設備，插座必須接近安裝之地點而且是易於觸及的。

## About the Symbols

Various symbols are used in this product to ensure correct usage, to prevent danger to the user and others, and to prevent property damage. The meaning of these symbols are described below. It is important that you read these descriptions thoroughly and fully understand the contents.

### Explanation of the Symbols

SYMBOL	EXPLANATION
	Alternating current (AC): AC is an electric current in which the flow of electric charge periodically reverses direction.
	Direct current (DC): DC is the unidirectional flow or movement of electric charge carriers.
	Earth; ground: A wiring terminal intended for connection of a Protective Earthing Conductor.
	Class II equipment: The method of protection against electric shock in the case of class II equipment is either double insulation or reinforced insulation.

### Viewing Certifications

Go to <http://www.zyxel.com> to view this product's documentation and certifications.

### Zyxel Limited Warranty

Zyxel warrants to the original end user (purchaser) that this product is free from any defects in material or workmanship for a specific period (the Warranty Period) from the date of purchase. The Warranty Period varies by region. Check with your vendor and/or the authorized Zyxel local distributor for details about the Warranty Period of this product. During the warranty period, and upon proof of purchase, should the product have indications of failure due to faulty workmanship and/or materials, Zyxel will, at its discretion, repair or replace the defective products or components without charge for either parts or labor, and to whatever extent it shall deem necessary to restore the product or components to proper operating condition. Any replacement will consist of a new or re-manufactured functionally equivalent product of equal or higher value, and will be solely at the discretion of Zyxel. This warranty shall not apply if the product has been modified, misused, tampered with, damaged by an act of God, or subjected to abnormal working conditions.

#### Note

Repair or replacement, as provided under this warranty, is the exclusive remedy of the purchaser. This warranty is in lieu of all other warranties, express or implied, including any implied warranty of merchantability or fitness for a particular use or purpose. Zyxel shall in no event be held liable for indirect or consequential damages of any kind to the purchaser.

To obtain the services of this warranty, contact your vendor.

### Open Source Licenses

This product may contain in part some free software distributed under GPL license terms and/or GPL-like licenses.

To request the source code covered under these licenses please go to:

[https://www.zyxel.com/form/gpl\\_oss\\_software\\_notice.shtml](https://www.zyxel.com/form/gpl_oss_software_notice.shtml)

<https://service-provider.zyxel.com/global/en/gpl-oss-software-notice>.

**A**

access  
  troubleshooting [352](#)

Access Control (Rules) screen [238](#)

access point  
  coverage area [22](#)

ACK message [283](#)

activation  
  firewalls [236](#)  
  SSID [148](#)

Address Resolution Protocol [301](#)

Any\_WAN  
  Remote Management [320](#)  
  TR-069 traffic [327](#)

APN information  
  obtain [126](#)

APN Settings [127](#)

Application Layer Gateway (ALG) [220](#)

applications  
  Internet access [19](#)  
  wireless WAN [19](#)

applications, NAT [222](#)

ARP Table [301](#)

authentication [163](#)

Authentication Type  
  APN [128, 129](#)

**B**

backup  
  configuration [344](#)

backup configuration [344](#)

Backup/Restore screen [342](#)

Band Configuration screen [133](#)

Basic Service Set, see BSS

Broadband [117](#)

BSS [165](#)  
  example [165](#)

BYE request [283](#)

**C**

CA [261](#)

call hold [288, 290](#)

call service mode [288, 289](#)

call transfer [289, 290](#)

call waiting [289, 290](#)

Cellular Band screen [133](#)

Cellular SIM screen [131](#)

Cellular WAN [320](#)  
  TR-069 traffic [327](#)

Cellular WAN screen [124, 126, 127](#)

certificate  
  details [263](#)  
  factory default [255](#)  
  file format [262](#)  
  file path [260](#)  
  import [255, 259](#)  
  public and private keys [261](#)  
  verification [262](#)

certificate request  
  create [255](#)  
  view [257](#)

certificates [254](#)  
  advantages [262](#)  
  authentication [254](#)  
  CA [254, 261](#)  
  creating [256](#)  
  public key [254](#)  
  replacing [255](#)  
  storage space [255](#)  
  thumbprint algorithms [262](#)  
  trusted CAs [259](#)  
  verifying fingerprints [262](#)

Certification Authority [254](#)

Certification Authority, see CA

certifications [375](#)  
  viewing [378](#)

- Class of Service [286](#)
  - Class of Service, see CoS
  - client list [178](#)
  - client-server protocol [280](#)
  - comfort noise generation [285](#)
  - configuration
    - backup [344](#)
    - firewalls [236](#)
    - restoring [344](#)
    - static route [225](#)
  - contact information [362](#)
  - controller
    - network [21](#)
  - copyright [373](#)
  - CoS [207](#), [286](#)
  - CoS technologies [204](#)
  - coverage area
    - access point [22](#)
    - repeater [22](#)
  - Create Certificate Request screen [256](#)
  - creating certificates [256](#)
  - CTS threshold [155](#), [163](#)
  - customer support [362](#)
  - customized service [237](#)
    - add [238](#)
  - customized services [238](#)
- ## D
- daisy chain
    - form [24](#)
  - data fragment threshold [155](#), [163](#)
  - Data Roaming
    - enable [127](#)
  - DDoS [235](#)
  - Denials of Service, see DoS
  - DHCP [173](#), [182](#)
  - DHCP Server Lease Time [176](#)
  - DHCP Server State [176](#)
  - diagnostic [348](#)
  - diagnostic screens [348](#)
  - differentiated services [287](#)
  - Differentiated Services, see DiffServ [207](#)
  - DiffServ [207](#)
    - marking rule [208](#)
  - DiffServ (Differentiated Services) [286](#)
    - code points [286](#)
    - marking rule [287](#)
  - digital IDs [254](#)
  - disclaimer [373](#)
  - DMZ screen [219](#)
  - DNS [173](#), [182](#)
  - DNS Values [176](#)
  - Domain Name [223](#)
  - domain name system, see DNS
  - DoS [234](#)
    - thresholds [235](#)
  - DoS protection blocking
    - enable [241](#)
  - DS field [207](#), [287](#)
  - DS, see differentiated services
  - DSCP [207](#), [286](#)
  - dual-band application [23](#)
  - dynamic DNS [224](#)
    - wildcard [224](#)
  - Dynamic Host Configuration Protocol, see DHCP
  - DYNDNS wildcard [224](#)
- ## E
- ECHO [223](#)
  - echo cancellation [285](#)
  - email
    - log example [336](#)
    - log setting [336](#)
  - Europe type call service mode [288](#)
  - Extended Service Set IDentification [144](#)
- ## F
- factory defaults
    - reset [345](#)
  - filters
    - MAC address [149](#), [164](#)
  - Finger services [223](#)

firewall

- enhancing security [243](#)
- LAND attack [235](#)
- security considerations [243](#)
- traffic rule direction [241](#)

Firewall DoS screen [241](#)

Firewall General screen [236](#)

firewall rules

- direction of travel [242](#)

firewalls [234](#), [236](#)

- actions [241](#)
- configuration [236](#)
- customized service [237](#)
- customized services [238](#)
- DDoS [235](#)
- DoS [234](#)
  - thresholds [235](#)
- ICMP [235](#)
- Ping of Death [235](#)
- rules [242](#)
- security [243](#)
- SYN attack [234](#)

firmware [338](#)

Firmware Upgrade screen [338](#), [340](#)

firmware upload [338](#), [340](#)

firmware version

- check [339](#)

flash key [288](#)

flashing [288](#)

fragmentation threshold [155](#), [163](#)

FTP [212](#), [223](#)

## G

G.168 [285](#)

General wireless LAN screen [142](#)

Guide

- Quick Start [2](#)

## H

HTTP [223](#)

## I

ICMP [235](#)

IGA [220](#)

ILA [220](#)

Import Certificate screen [259](#)

importing trusted CAs [259](#)

Inside Global Address, see IGA

Inside Local Address, see ILA

Internet

- no access [357](#)
- wizard setup [57](#)

Internet access [19](#)

- wizard setup [57](#)

Internet Blocking [104](#)

Internet connection

- slow or erratic [358](#)

Internet Control Message Protocol, see ICMP

Internet Protocol version 6, see IPv6

IP address [183](#)

- private [183](#)
- WAN [118](#)

IP address access control [323](#)

IP alias

- NAT applications [222](#)

IP Passthrough mode [137](#)

IP Passthrough screen [52](#), [136](#), [137](#), [139](#)

IPv4 firewall [237](#)

IPv6 [367](#)

- addressing [367](#)
- EUI-64 [369](#)
- global address [367](#)
- interface ID [369](#)
- link-local address [367](#)
- Neighbor Discovery Protocol [367](#)
- ping [367](#)
- prefix [367](#)
- prefix length [367](#)
- unspecified address [368](#)

IPv6 firewall [237](#)

ITU-T [285](#)

**K**

key combinations [291](#)  
 keypad [291](#)

**L**

LAN [172](#)  
   client list [178](#)  
   DHCP [182](#)  
   DNS [182](#)  
   IP address [183](#)  
   MAC address [159, 179](#)  
   status [106, 116](#)  
   subnet mask [174, 183](#)  
 LAN IP address [176](#)  
 LAN IPv6 Mode Setup [177](#)  
 LAN Setup screen [174](#)  
 LAN subnet mask [176](#)  
 LAND attack [235](#)  
 limitations  
   wireless LAN [165](#)  
   WPS [171](#)  
 listening port [272](#)  
 Local Area Network, see LAN  
 local certificate  
   TR-069 client [327](#)  
 Local Certificates screen [254](#)  
 log setting [334](#)  
 Log Setting screen [334](#)  
 login [48](#)  
   password [49](#)  
 Login screen  
   no access [352](#)  
 logs [292, 308](#)

**M**

MAC address [151, 159, 179](#)  
   filter [149, 164](#)  
   LAN [179](#)  
 MAC Authentication screen [150](#)  
 MAC Filter [245](#)

managing the device  
   good habits [27](#)  
 MBSSID [166](#)  
 Mesh application [22](#)  
 MGMT Services screen [319, 322](#)  
 Multi\_WAN  
   Remote Management [320](#)  
   TR-069 traffic [327](#)  
 multimedia [279](#)  
 Multiple BSS, see MBSSID

**N**

NAT [220, 221](#)  
   applications [222](#)  
     IP alias [222](#)  
   default server [219](#)  
   DMZ host [219](#)  
   example [222](#)  
   global [221](#)  
   IGA [220](#)  
   ILA [220](#)  
   inside [221](#)  
   local [221](#)  
   multiple server example [212](#)  
   outside [221](#)  
   port number [223](#)  
   services [223](#)  
 NAT ALG screen [220](#)  
 NAT example [223](#)  
 Network Address Translation, see NAT  
 network disconnect  
   temporary [339](#)  
 network map [52, 104](#)  
 network type  
   select [133](#)  
 NNTP [223](#)  
 Nslookup test [349](#)

**O**

OK response [283, 284](#)  
 online firmware [340](#)  
 Others screen [154](#)

**P**

password **49**  
 admin **352**  
 good habit **27**  
 lost **352**  
 user **352**

PBC **167**

Per-Hop Behavior, see PHB **208**

PHB **208, 287**

phone functions **291**

PIN Protection **132**

PIN, WPS **167**  
 example **168**

Ping of Death **235**

Ping test **349**

Ping/TraceRoute/Nslookup screen **348**

PLMN Configuration screen **133**

Point-to-Point Tunneling Protocol, see PPTP

POP3 **223**

port forwarding rule  
 add/edit **213**

Port Forwarding screen **212, 213**

Port Triggering  
 add new rule **217**

Port Triggering screen **215**

PPTP **223**

preamble **156, 163**

preamble mode **166**

private IP address **183**

problems **351**

Protocol (Customized Services) screen **237**

Protocol Entry  
 add **238**

Push Button Configuration, see PBC

push button, WPS **167**

**Q**

QoS **203, 207, 286**  
 marking **204**  
 setup **203**  
 tagging **204**  
 versus CoS **203**

Quality of Service, see QoS

Quick Start Guide **2**

**R**

Real time Transport Protocol, see RTP

Reboot screen **347**

RESET Button **45**

reset to factory defaults **345**

restart system **347**

restoring configuration **344**

RFC 1058, see RIP

RFC 1389, see RIP

RFC 1631 **211**

RFC 1889 **282**

RIP **201**

router controller **22**

router features **19**

Routing Information Protocol, see RIP

routing table **303**

RTP **282**

RTS threshold **155, 163**

**S**

security  
 network **243**  
 wireless LAN **163**

Security Log **293**

Security Parameter Index, see SPI

service access control **321, 322**

Service Set **144**

services  
 port forwarding **223**

Session Initiation Protocol, see SIP

setup  
 firewalls **236**  
 static route **225**

silence suppression **285**

SIM card  
 status **108, 310**

SIM configuration **131**

Single Rate Three Color Marker, see srTCM

SIP **279**

- account **279**
- call progression **282**
- client **280**
- identities **279**
- INVITE request **283, 284**
- number **279**
- OK response **284**
- proxy server **280**
- redirect server **281**
- register server **282**
- servers **280**
- service domain **279**
- URI **279**
- user agent **280**

SMTP **223**

SNMP **223**

SNMP trap **223**

SPI **235**

srTCM **209**

SSH

- unusable **354**

SSID **164**

- activation **148**
- MBSSID **166**

static DHCP **178**

- configuration **180**

Static DHCP screen **178**

static route **192, 201**

- configuration **225**

status **104**

- LAN **106, 116**
- wireless LAN **107**

subnet mask **183**

supplementary services **287**

SYN attack **234**

syslog logging

- enable **335**

syslog server

- name or IP address **336**

system

- firmware **338**
- online firmware **340**
- password **49**
- status **104**
- LAN **106, 116**

wireless LAN **107**

time **328**

## T

Telnet

- unusable **354**

three-way conference **289, 290**

thresholds

- data fragment **155, 163**
- DoS **235**
- RTS/CTS **155, 163**

time **328**

ToS **286**

TR-069

- authentication **327**

TR-069 Client screen **325**

Trace Route test **349**

troubleshooting **351**

trTCM **210**

Trust Domain

- add **321**

Trust Domain screen **321**

Trusted CA certificate

- view **260**

Trusted CA screen **258**

Two Rate Three Color Marker, see trTCM

Type of Service, see ToS

## U

Uniform Resource Identifier **279**

Universal Plug and Play, see UPnP

upgrading firmware **338**

upgrading online firmware **340**

uplink connection

- WiFi **24**
- wired **24**

UPnP **180**

- forum **173**
- NAT traversal **173**
- security issues **173**
- state **181**



usage confirmation [173](#)  
UPnP screen [180](#)  
UPnP-enabled Network Device  
  auto-discover [186](#)  
USA type call service mode [289](#)

## V

VAD [285](#)  
voice activity detection [285](#)  
voice coding [284](#)  
VoIP [279](#)

## W

WAN  
  Wide Area Network, see WAN [117](#)  
warranty  
  note [378](#)  
Web Configurator  
  login [48](#)  
  password [49](#)  
WEP [145](#)  
WEP Encryption [146](#)  
WiFi  
  MBSSID [166](#)  
Wireless General screen [142](#)  
wireless LAN [141](#)  
  authentication [163](#)  
  BSS [165](#)  
    example [165](#)  
  example [161](#)  
  fragmentation threshold [155, 163](#)  
  limitations [165](#)  
  MAC address filter [149, 164](#)  
  preamble [156, 163](#)  
  RTS/CTS threshold [155, 163](#)  
  security [163](#)  
  SSID [164](#)  
    activation [148](#)  
  status [107](#)  
  WPS [166, 168](#)  
    example [170](#)  
    limitations [171](#)

  PIN [167](#)  
    push button [167](#)  
  Wireless tutorial [65](#)  
  wizard setup  
    Internet [57](#)  
  WMM screen [153](#)  
  WPA [145](#)  
  WPA2 [145](#)  
  WPA2-PSK [145](#)  
  WPA3-SAE (Simultaneous Authentication of Equals  
    handshake) [146](#)  
  WPA-PSK (WiFi Protected Access-Pre-Shared  
    Key) [145](#)  
  WPS [166, 168](#)  
    example [170](#)  
    limitations [171](#)  
    PIN [167](#)  
      example [168](#)  
      push button [167](#)  
  WPS screen [151](#)